



City of Richmond

PUBLIC INFRASTRUCTURE DESIGN MANUAL

Adopted: NOVEMBER 21, 2016

Latest Update: March 2020

CITY ENGINEER:

KALUZA, INC.

Consulting Engineers & Surveyors

Engineering Firm No. F-1339 ■ Surveying Firm No. 10010000

3014 Avenue I, Rosenberg, Texas 77471

(281) 341-0808 # FAX (281) 341-6333

TABLE OF CONTENTS

Public Infrastructure Design Manual

	<u>PAGE</u>
Record of Changes	Preface
 Chapter 1 – General Requirement	
1.1 General	1-1
1.2 Reference.....	1-1
1.3 Definitions	1-2
1.4 Plat and Construction Drawing Review Process	1-4
1.5 Quality Assurance	1-5
1.6 Capacity Allocations.....	1-6
1.7 Construction Procedure Requirements for Public Works Projects....	1-6
1.8 Approval and Acceptance of Public Works Projects.....	1-7
1.9 Approvals	1-9
1.10 Variances	1-10
 Chapter 2 – Survey Requirements	
2.1 General	2-1
2.2 References... ..	2-1
2.3 Definitions.....	2-1
2.4 Design Requirements.....	2-2
2.5 Submittals	2-2
2.6 Quality Assurance	2-2
2.7 Field Work	2-3
2.8 Calculations.....	2-4
2.9 Construction Drawings	2-4
2.10 Right-of-Way Maps.....	2-5
2.11 Documents	2-6
2.12 Survey Requirements for all Projects within Richmond.....	2-6
 Chapter 3 – Construction Plan Requirements	
3.1 General	3-1
3.2 Design Requirements.....	3-1
3.3 Minimum Required Plan Sheets... ..	3-5
3.4 Graphic Standards.....	3-5

Chapter 4 – Street Lighting & Overhead Utilities

4.1 General 4-1
4.2 Design Requirements..... 4-1
4.3 Responsibility for Installation and Maintenance in Existing
Developments 4-2
4.4 Responsibility for Installation and Maintenance in New
Developments 4-3
4.5 Ornamental Street Lights 4-4
4.6 Technical Requirements..... 4-4
4.7 Special Conditions 4-6
4.8 Overhead Utility Placement..... 4-6

Chapter 5 – Water Distribution System

5.1 General 5-1
5.2 Design Requirements..... 5-1
5.3 System Layout and Placement..... 5-2
5.4 Fire Hydrants (Flushing Valves) 5-4
5.5 Water Distribution System Materials 5-6
5.6 Location of Water Mains and Easement Requirements..... 5-6
5.7 Clearance of Water Lines from Other Utilities 5-7
5.8 Depth of Cover 5-8
5.9 Bedding and Backfill Requirements..... 5-8
5.10 Valves 5-9
5.11 Fittings and Appurtenances..... 5-10
5.12 Ductile Iron Water Pipe 5-11
5.13 Testing of Installed Pipe 5-11
5.14 Existing Facility Crossings..... 5-11
5.15 Water Services 5-11
5.16 Additional Standards 5-13

Chapter 6 – Sanitary Sewer System

6.1 General 6-1
6.2 Design Requirements..... 6-1
6.3 System Layout and Placement..... 6-3
6.4 Sanitary Sewer Bedding and Backfill Requirements..... 6-7
6.5 Sanitary Sewer System Materials..... 6-8
6.6 Location of Sanitary Sewer and Easement Requirements 6-9
6.7 Clearance of Water Lines from Sanitary Sewer Lines 6-10
6.8 Lift Stations and Force Mains..... 6-10
6.9 Testing of Installed Pipe and Manholes... 6-16
6.10 Existing Facility Crossings... 6-17
6.11 Additional Standards..... 6-17

Chapter 7 – Storm Water System Design Requirements

7.1 General 7-1
7.2 Definitions 7-2
7.3 Design Requirements..... 7-3
7.4 Storm Sewer Design Requirements..... 7-4
7.5 Storm Sewer Easement Requirements. 7-11
7.6 Open Channel Design and Roadside Ditches Requirements 7-13
7.7 Storm Water Detention Requirements... 7-15
7.8 Minimum Plat and Construction Plan Requirements 7-18
7.9 Additional Standards 7-19

Chapter 8 – Driveway and Access Requirements

8.1 General 8-1
8.2 Definitions..... 8-1
8.3 Design Requirements..... 8-2
8.4 Single Family Residential Driveway Requirements 8-4
8.5 Multi-Family Residential Requirements. 8-5
8.6 Non-residential Requirements..... 8-5
8.7 Driveways Along Major Thoroughfare and Collectors 8-6

Chapter 9 – Traffic Impact Analysis Requirements

9.1 General 9-1
9.2 When Traffic Impact Analyses are Required 9-1
9.3 Scope of Required Traffic Impact Analysis (TIA)..... 9-3
9.4 Submission and Review Procedures... 9-4
9.5 Funding Resources. 9-5
9.6 Traffic Impact Studies Report Requirements..... 9-5
9.7 Technical Notes 9-11
9.8 Traffic Impact Study Checklist 9-14

Chapter 10 – Traffic Signal Requirements

10.1 General 10-1
10.2 Traffic Signal System Design Guidelines 10-1
10.3 Construction Plan Requirements..... 10-3
10.4 Approved Products..... 10-10
10.5 Signal Activation..... 10-10

Chapter 11 – Roadways, Sidewalks & Transportation Design Requirements

11.1	General	11-1
11.2	General Roadway Design	11-1
11.3	Horizontal Curvature	11-8
11.4	Vertical Curvature	11-9
11.5	General Intersection Requirements... ..	11-11
11.6	Intersection Right-of-Way Requirements.....	11-12
11.7	Median, Left-turn Lane, Right-turn Lane, Deceleration Lane and Island Design	11-13
11.8	Alley and Service Road Design.....	11-21
11.9	Gated Development Entrance Requirements.....	11-22
11.10	Sidewalk and Trail Design.....	11-23
11.11	Public Right-of-Way Visibility Requirements.....	11-25
11.12	Pavement Structure Requirements	11-29
11.13	Reinforced Concrete Pavement Materials.....	11-30
11.14	Grading and Layout Requirements.....	11-31
11.15	Cul-de-sac Pavement.....	11-32
11.16	Traffic Control Devices	11-33
11.17	Traffic Calming Guidelines	11-33

Chapter 12 – Right-of-Way Use, Utility Locations and Grading Permit Requirements

12.1	General	12-1
12.2	Definitions.....	12-2
12.3	Right-of-Way Use Permits.....	12-3
12.4	Insurance and Bonding Requirements.....	12-7
12.5	Grading Permits.....	12-9
12.6	Public and Private Utility Locations	12-10

Chapter 13 – Quality Control & Construction Material Testing Requirements

13.1	General	13-1
13.2	References and Requirements... ..	13-1
13.3	Pavement Subgrade	13-2
13.4	Concrete Pavement and Utility Construction Concrete	13-3
13.5	Asphaltic Concrete Pavement	13-5
13.6	Cement Stabilized Sand.....	13-6
13.7	Bedding, Backfill, Embankments and Lot Fill.....	13-6
13.8	Utility Construction	13-7

Chapter 14 – Public Water Plant Requirements

14.1 General 14-1
14.2 Site Requirements... 14-1
14.3 Water Well Requirements 14-3
14.4 Booster Pumps... 14-6
14.5 Headers and Yard Piping 14-8
14.6 Booster Pump Buildings... 14-11
14.7 Electrical, Monitoring and Control Systems 14-13
14.8 Hydropneumatic Tanks..... 14-17
14.9 Potable Water Storage Tanks..... 14-18
14.10 Emergency Power 14-22
14.11 Chlorination Systems 14-23
14.12 Initial Water Plants 14-26

Chapter 15 – Graphic Standards & Drawing Requirements

15.1 General 15-1
15.2 GIS Standards & Data Requirements... 15-1
15.3 GIS Feature Classes within a Geodatabase or Shapefiles-General
Guidelines..... 15-1
15.4 Water Utilities Feature Requirements and Data Descriptions..... 15-2
15.5 Sanitary Sewer Utilities Feature Requirements and Data
Descriptions..... 15-3
15.6 Storm Sewer Utilities Feature Requirements and Data
Descriptions..... 15-4
15.7 AutoCAD Drawing layer Requirements/Feature Class within
GDB/Shapefile/AutoCAD Required..... 15-10
15.8 Graphic Standards..... 15-11

Chapter 16 – Miscellaneous Requirements

16.1 Crossings..... 16-1
16.2 Trench Safety..... 16-2
16.3 Residential Lots and Improvements 16-2
16.4 Flood Plain Management 16-3
16.5 Barricades and Traffic Control..... 16-3
16.6 Approved Products List 16-4
16.7 Richmond Standard Construction Details..... 16-4



City of Richmond

Design Manual

Chapter 1

GENERAL REQUIREMENTS

CHAPTER 1

GENERAL REQUIREMENTS

1.01 GENERAL

- A. This chapter describes the general requirements of the construction process and for the preparation of construction plans and the supporting documents required within the city limits and the extra-territorial jurisdiction of the City of Richmond. This chapter also describes procedural requirements for the construction process within Richmond.
- B. The Richmond Public Works Department shall approve construction plans for public improvements within the Richmond city limits or extraterritorial jurisdiction.
- C. Construction plans for private improvements within public right-of-ways and public easements that connect to or affect the public infrastructure shall be approved by the City of Richmond subject to the requirements of this manual and are subject to review and approval using the process defined in this manual.
- D. Public Works Department personnel will be available for preliminary meetings to discuss a proposed project with the project engineer. This preliminary meeting between the City and the engineer should be scheduled with the Department of Public Works staff prior to submittal of any documents for review. The purpose of this meeting is to discuss the project concepts and to establish the status of requirements and issues that may be pertinent to the project.
- E. This manual is intended to set a standard of design for the City of Richmond and the Richmond extra-territorial jurisdiction that is consistent, cost-effective, efficient, maintainable and protects public safety. These Standards are a guide for design, but not a substitute for good engineering. It is the obligation of the designer to use these standards responsibly and professionally to produce designs conforming to commonly accepted engineering practices. It will at times be desirable and/or necessary to vary from the standards in this manual to produce a product in accordance with these goals. When the need arises, please refer to the section on variances.
- F. Any reference by this manual to any law, regulation, rule, publication, or any other source shall refer to the most recently adopted, promulgated, or otherwise effective version applicable as such may be amended from time to time.

1.02 REFERENCES

All projects that are required to conform to these Standards shall also be in compliance with all applicable City ordinances. All construction plans and supporting documentation shall conform to the requirements of these Standards and all applicable regulations of all Federal, State, County, and Local entities having jurisdiction. Relevant related laws and regulations included but are not limited to the following:

- A. City of Richmond
- B. Fort Bend County
- C. State of Texas
 - 1. Texas Accessibility Standards (TAS), pursuant and subject to the Texas Government Code, Chapter 469, and the Texas Administrative Code, Title 16, Chapter 68.

2. Rules and Regulations published by the Texas Commission on Environmental Quality (TCEQ):
 - i. Rules and Regulations for Public Water Systems, Texas Administrative Code, Title 30, Chapter 290, Subchapter D.
 - ii. Design Criteria for Domestic Wastewater Systems, Texas Administrative Code, Title 30, Chapter 217.
 - iii. TCEQ storm water pollution prevention protection standards.
3. State of Texas Engineering Practice Act, Texas Occupations Code, Chapter 1001.
4. Professional Land Surveying Practices Act, Texas Occupations Code, Chapter 1071.
5. Texas Manual on Uniform Traffic Control Devices.

D. National

1. Americans with Disabilities Act, 42 U.S.C. § 12101 et seq and regulations, 28 CFR Part 36.
2. American Association of Highway and Transportation Officials, A Policy on Geometric Design of Highways and Streets.
3. Institute of Transportation Engineers, Traffic Engineering Handbook.
4. Highway Capacity Manual, National Research Council, Transportation Research Board.

1.03 DEFINITIONS

For the purposes of this manual, the following words and phrases shall have the meanings respectively ascribed to them by this section.

City Code – The code of Ordinances of the City of Richmond, Texas.

City Engineer - The City Engineer or his designee.

Collector Streets - Street routes that have short travel distances and collect traffic from intra-city streets and funnel it into major thoroughfares or other collector streets.

Commercial Driveway Approach - The portion of a driveway within the public right-of-way that provides access to property on which an office, retail commercial center, or a building having more than three dwelling units is located or any driveway approach which accesses property that is primarily used for a non-residential purpose.

County –The applicable political subdivision of the State of Texas in which a subject tract is located. Richmond city limits and its extra-territorial jurisdiction is within Fort Bend County.

Design Analysis - Narratives and calculations necessary to support design of a project.

Director of Public Works - The Director of Public Works or his designee.

Drawings - Plan, profile, detail, and other graphic sheets to be used in a construction contract, which define character and scope of the project.

Driveway - Entrance to and exit from premises where it is possible to park completely off the street, and which is not open for vehicular traffic except by permission of the owner of such private property.

Driveway Approach - A way or place including paving and curb returns between the street travel lanes and private property that provides vehicular access between the roadway and said private property.

Dwelling Unit - A building or portion thereof designed exclusively for residential occupancy.

Highway, Street, or Roadway - A general term denoting a public or private way for the purpose of vehicular travel.

Infrastructure - Any facility or structure proposed to be constructed, reconstructed, repaired, or regraded wholly or partially within right-of-way public easements or connecting to right-of-way, including, but not limited to, streets, driveways, sidewalks, curbs, gutters, culverts, open ditches, storm drains, and irrigation facilities owned or maintained by a public entity.

Intersection - The area embraced within the prolongation or connection of the lateral curb lines, or, if none, then the lateral boundary lines of two or more roadways, including public street, private street, commercial driveway, residential driveway, driveway approach, alley or combination thereof which join one another at, or approximately at, right angles, or the area within which vehicles traveling upon different roadways joining at any other angle may come into conflict.

Major Thoroughfare - Highways, streets and roadways devoted to moving large volumes of traffic over long distances. Major thoroughfares shall be set forth in the Major Thoroughfare Plan adopted by City Council and may from time to time be amended.

Professional Engineer - An engineer currently licensed by and in good standing with the Texas Board of Professional Engineers.

Professional Land Surveyor - A surveyor currently registered with and in good standing with the State of Texas Board of Professional Land Surveying.

Project Engineer Representative – A representative of the design engineer who possesses the knowledge, skills and abilities to carry out inspection duties to insure compliance with the approved plans and specifications.

Private Projects or Private Improvements - All projects involving construction, reconstruction, modification or maintenance of privately-owned/maintained facilities including, but not limited to, buildings, parking lots, utility systems, private shared access drives and any facility supporting functions within private property boundaries.

Public Works Projects, Public Improvements or Public Projects – All projects involving construction, reconstruction, modification or maintenance of public infrastructure, including, but not limited to, streets, drainage facilities, water and wastewater systems, construction in public rights-of-way or easements. Any project that will be accepted for permanent maintenance by a public agency or political subdivision of the State of Texas. Any project subject to review and approval by the terms of Section 1.01 of this chapter.

Residential Developments - Residential developments shall mean all areas identified as residential under the Richmond City Zoning Ordinance or otherwise zoned or devoted primarily to residential use.

Residential Driveway Approach - The portion of a driveway within the public right-of-way that provides access to property on which a single-family residence, duplex, or multi-family building containing three or fewer dwelling units is located.

Residential Streets - Street routes that provide access to local property owners and which connect property to major thoroughfares or collector street networks.

Residential Structure - A single-family home, apartment house, townhouse, condominium or any other

type of dwelling unit.

Review Authorities - The authorized representatives of City departments, divisions, or sections responsible for reviewing and approving calculations and drawings for privately funded projects and for design and construction contracts with the City.

Right-of-way - Property that is publicly owned or upon which a governmental entity has an express or implied property interest (e.g. fee title, easement, etc.) held for a public purpose. Examples of such public purpose include by way of example and not limitation, highways, streets, sidewalks, drainage facilities, sewerage and water facilities.

Sidewalk – The section of pavement between the curb lines of a roadway and the adjacent property lines or located within an easement intended for the use of pedestrians.

Specifications - City of Richmond Standard Specifications plus project-specific narrative descriptions of procedures, requirements, and materials for a particular project.

Standards – The requirements of this design manual.

Subdivision Ordinance – City of Richmond Subdivision Ordinance as it may be amended from time to time.

Traffic Impact Analysis - A study performed by engineers with expertise in traffic engineering principles and practice which reviews development of a specific property and how it integrates into the existing and proposed Richmond street network. The analysis utilizes data and conclusions developed in previous studies and identifies improvements needed to mitigate the impact of traffic generated by a development on the street network system.

1.04 PLAT AND CONSTRUCTION DRAWING REVIEW PROCESS

- A. Plat approval shall be performed in accordance with City of Richmond Subdivisions Ordinance.
- B. A recorded plat shall be on file with the appropriate County Clerk prior to final approval of the construction plans. A copy of the final, recorded plat is required in all plan sets, prior to approval for permitting. All separate or special easements that may be required for construction shall be recorded in the appropriate County Official Records prior to final approval of the construction plans, except with specific approval of the Department of Public Works.
- C. The applicant shall obtain and complete a plan review application form for each review phase. Plan reviews are subject to a review fee as established by resolution in the schedule of fees. Submit one (1) copy of the construction plans and supporting documentation and one copy in electronic Adobe Acrobat (.PDF) format to the Department of Public Works for review. Plans will be reviewed and typed comments will be returned to the submitting design professional in a timely manner.
- D. If a project has begun the review process and becomes inactive for a period of 12 consecutive months from the date of last correspondence, the project will be considered stopped. If the project is not reactivated before the fifth anniversary of the date that the first permit application for the project was filed and no progress has been made towards completion of the project, any submission will be treated as a new submittal, subject to all current requirements and changes in codes or ordinances.

- E. If a project has begun the review process but becomes inactive for a period of 12 months from the date of the last correspondence, the project will be considered stopped. Projects re-activated after 12 months of inactivity will be treated as new submittals, subject to all current requirements and changes in codes or ordinances.
- F. Submit an indexed listing of all variances and/or deviations from the requirements of the City of Richmond Design Manual and/or the Standard Construction Details with the original plan submittal.
- G. Submit approval letters based on the final project plan from all public utilities affected by the project. All approval letters shall state that service will be available to the project, where appropriate, and that there is no objection to the project.
- H. Upon receipt of a “No Comments” plan review, submit the mylar construction plan sheets to the Department of Public Works for signatures. A standard City of Richmond approval signature block shall be provided on the cover sheet. For Private Development the standard approval block shall have a signature line for the City Engineer and shall state “Approval void if no progress has been made toward completion of the project within five (5) years of date of signature.”
- I. After all comments have been adequately addressed, submit one (1) copy of the revised and final construction plans to the Department of Public Works for signature.
- J. Upon receipt of a “No Comments” plan review, submit the mylar construction plan sheets to the Department of Public Works for signatures. A standard City of Richmond approval signature block shall be provided on the cover sheet. For Private Development the standard approval block shall have a signature line for the City Engineer and shall state “Approval void if no progress has been made toward completion of the project within two (2) years of date of signature.”
- K. Signature of the City Engineer on approved construction drawings for utilities that are intended to remain private, does not infer acceptance of the City for ownership or maintenance or operation of facilities indicated on the drawings.

1.05 QUALITY ASSURANCE

- A. Surveying and platting shall be accomplished under direction of a Professional Land Surveyor. Recording documents shall be sealed, signed, and dated by a Professional Land Surveyor.
- B. Engineering calculations shall be prepared by or under the direct supervision of a Professional Engineer trained and licensed in disciplines required by the project scope and sealed by the Professional Engineer. Final engineering design drawings shall be sealed, signed, and dated by the Professional Engineer responsible for development of the drawings.
- C. Final architectural design drawings shall be sealed, signed, and dated by the licensed Architect responsible for development of the drawings.
- D. Final landscape architecture design drawings shall be sealed, signed, and dated by the licensed Landscape Architect responsible for development of the drawings.
- E. Final irrigation design drawings shall be sealed, signed and dated by a Texas Professional Engineer, a licensed irrigator or a licensed Landscape Architect.

1.06 CAPACITY ALLOCATIONS

- A. Construction plan approval shall not infer that capacity is committed for service to the property. A capacity allocation for service to the development and approval of the connection design shall be secured separately prior to connection to water and wastewater facilities.
- B. Prior to beginning construction on a project, a current commitment of drainage capacity for the proposed development, including the status of any drainage fees that may be due or have been paid, will be required. The commitment shall be issued by the relevant agencies such as the Fort Bend County Drainage District, the City of Richmond, the Municipal Utility District, or the Levee Improvement District as applicable.

1.07 CONSTRUCTION PROCEDURE REQUIREMENTS FOR PUBLIC WORKS PROJECTS

- A. Construction on public works projects and construction within public rights-of-way and easements shall not begin until construction plans are approved by the Director of Public Works, and a Permit has been issued. A schedule of fees is on file in the Department of Public Works. Construction shall not begin within an existing easement or right-of-way until all permits and/or any right-of-way use agreements are negotiated between the affected parties.
- B. Schedule a pre-construction meeting with the Department of Public Works at least forty-eight (48) hours prior to the desired start of construction for the project. Department of Public Works staff must attend the pre-construction meeting, which will be held at the City Hall Annex, unless specifically approved by the Director of Public Works.
- C. Notify the Department of Public Works at least forty-eight (48) hours prior to beginning construction. The Department of Public Works staff will make periodic inspections. The Department of Public Works shall be notified at least twenty-four (24) hours prior to each time concrete is placed on the project. The Department of Public Works shall be notified at least twenty-four (24) hours prior to all pipe inspection tests and other tests that may be required by the Department of Public Works. All Saturday construction shall be scheduled with the Department of Public Works at least 48 hours in advance. There will be no construction or inspections made on Sundays unless in case of emergency. Request for Sunday or holiday construction or inspections shall be made in writing and submitted to the Director of Public Works for approval within 72 hours of intent. All Saturday, Sunday or holiday inspections will be on a fee basis paid directly to the City prior to final approval of the project. A schedule of fees is on file in the Department of Public Works.
- D. Notify the Department of Public Works at least forty-eight (48) hours prior to a final inspection. The Department of Public Works staff and representatives of all entities having jurisdiction shall be present during all final inspections (i.e., Fort Bend County, Municipal Utility District, TCEQ, TxDOT, etc.).
- E. For all projects, upon request, all delivery tickets for materials, (e.g., concrete, cement stabilized sand) shall be submitted to the Department of Public Works. These delivery tickets shall be maintained by the Engineer of Record for a maximum of one year from the completion of the project.
- F. Significant changes from approved construction plans shall be approved by the Department of Public Works prior to construction. The Project Engineer will submit change order requests in writing to the Public Works Department. The Public Works Department will respond in writing within five (5) working days.

- G. Competent, full-time resident inspection by the Project Engineer's representative shall be provided at all critical points of construction and as deemed necessary by the City. Critical points of construction include, but are not limited to, operations involving inspection of bedding and pipe prior to backfilling, placing and compaction of backfill, placement of structural concrete and paving, sidewalk placement- and all on-site testing activities.
- H. A certified testing laboratory shall be on site to perform applicable tests required so that construction practices and materials conform to plan and specification requirements.
- I. All disturbed areas must be properly re-vegetated prior to demobilization and acceptance of project.

1.08 APPROVAL AND ACCEPTANCE OF PUBLIC WORKS PROJECTS

- A. Public Works projects shall have final approval of the Director of Public Works and/or the City Engineer, prior to placing the facilities in service.
- B. Acceptance into the one-year maintenance period by the Department of Public Works shall be granted when the following items are complete:
 - 1. Construction is completed in accordance with the approved construction plans and final inspection punchlist items have been corrected and completed.
 - 2. All information required by Section 1.08 and the Final Packet Checklist included in Section 1.08E and record drawings have been submitted to the Department of Public Works. The project record drawings shall include one set of reproducible record drawings and one electronic copy of the record drawings in Adobe Acrobat (.PDF) and in the appropriate GIS shape file format per Chapter 16 compatible with City software. Record drawings shall reflect the facilities constructed and all significant horizontal and vertical changes made from the approved plans during construction. The project engineer shall certify the correctness of the record drawings and compliance of construction in accordance with these Standards.
 - 3. All pertinent test reports including concrete tests, density tests, bacteriological samples, mandrel and hydrostatic have been submitted to the Department of Public Works.
 - 4. Street lighting plans have been approved by the Director of Public Works.
 - 5. Appropriate payment and maintenance bonds have been secured and copies provided to the City for the specified period. Bonds shall be provided from bonding companies holding a certificate of authority as an acceptable surety on Federal Bonds (as published annually in the Federal Register). The requirements of each specific bond are defined for the City of Richmond and for the City's extraterritorial jurisdiction as follows.

Water, sanitary sewer, drainage and other utility improvements (W, S & D) – Require a maintenance bond for 100% of the total construction cost in the name of the City (if a City project) or the name of the appropriate municipal utility district (if a MUD project). All drainage facilities, including but not limited to storm lines, inlets, manholes, ponds, pumps and related appurtenances must be covered within the bond. The bond shall remain in effect until the end of the one-year maintenance period.

Paving Improvements - Require a maintenance bond for 100% of the total construction cost in the name of the City. The bond shall remain in effect until acceptance of the improvements, by the City of Richmond, and required street lights are installed and operational

Lift stations, water and wastewater plants, pumps and associated infrastructure require a maintenance bond for 100% of the total construction cost in the name of the City. Warranty period of equipment shall remain in effect for a minimum of one year after being placed on-line. The bond shall remain in effect until acceptance of the improvements, by the City of Richmond, and any required equipment and facilities are operational and long-term function is ensured.

6. All other jurisdictional public entities have given their approval on the project.
 7. The project engineer has provided a certification that all materials installed in the Project are completely in place in accordance with approved plans and specifications.
 8. The contractor has provided a notarized affidavit that all labor and material bills have been paid.
- C. Acceptance of water, wastewater and storm sewer utilities by applicable municipal utility district must be submitted to the City Engineer unless a variance is granted. Final approval and the release of the one-year maintenance period by the Department of Public Works will be documented by the Director of Public Works in writing.
- D. Public Works projects within the City of Richmond and extraterritorial jurisdiction will be subject to a one (1) year maintenance period. An inspection prior to the end of the maintenance period of a Public works project shall be conducted by the Department of Public Works and all other entities having jurisdiction and a punchlist of items to correct shall be issued. If the punchlist items are not corrected and accepted by the City within 30 days the generation of the punchlist, the project shall be subject to re-inspection and the generation of a new punchlist.

The Engineer or Developer shall contact the City to schedule the one-year maintenance inspections. Maintenance bonds are required to be in force until final acceptance by the City. Prior to final acceptance by the City, owner shall be responsible for all maintenance. All facilities, including street lighting and electricity in lift stations, shall be operational and in good condition prior to final acceptance of a project.

- E. The following project closeout documents, where applicable, shall be submitted on CDs containing PDF copies of all documents properly labeled and indexed in the following order:
1. Certificate of Completion for W, S & D and Paving.
 2. Maintenance Bond for W, S & D and Paving.
 3. Affidavit of Bills Paid for W, S & D and Paving.
 4. Consent of Surety for W, S & D and Paving.
 5. Release of Lien for W, S & D and Paving.
 6. Sealed copy of all Lab Reports.
 7. Letter of Approval, if applicable, from the Municipality, and Levee Districts.
 8. Copy of Pavement Core Thickness Test Reports.
 9. Copy of Manhole Vacuum Test Reports.
 10. Copy of Bacteriological Test Reports.
 11. Copy of Water Line Pressure Test Report.

12. Copy of Sanitary Line Pressure Test Report.
 13. Copy of Mandrel Test Reports.
 14. Proof of After Hour Inspections Paid from C. O. R.
 15. Proof of M. C. I. Permit Paid from C. O. R.
 16. (on separate CD) Engineer Certified "RECORD DRAWINGS" be submitted in GIS shape file format, per Chapter 16 an electronic copy in PDF format showing engineer's seal and signature and one (1) hard copy. These drawing shall be layered as required in Chapter 16 and shall be referenced to grid units, NOT surface units. All GIS requirements as outlined in Chapter 16 must also be met.
 17. Permanent Survey Controller Monument (BRASS DISK) Marker data sheet signed, sealed and fully completed (refer to datasheet template in Chapter 2 of this manual) submitted in PDF format.
 18. Copy of the Bid Tabulation of the actual construction price for the contract.
 19. Copy of the approved street light layout and as-built (either full-size or half-size). Copy of agreement executed between the city and street light maintenance entity (i.e. homeowners association).
 20. Copy of all traffic analysis reports and associated timing plans and traffic models.
 21. Copy of all drainage analysis reports and associated calculations and models.
 22. Copy of letter certifying maintenance responsibility of drainage facilities.
 23. Copy of recorded plat.
- F. All of the above must be sent together in a packet. These items shall not be accepted individually, nor will they be accepted prior to the commencement of the one-year maintenance period and Completion of the Punch List. Incomplete packets will be rejected.

1.09 APPROVALS

- A. Approvals required in these Standards are the responsibility of the Owner/Agent. Failure to obtain appropriate approvals may be grounds for suspension of construction until appropriate approvals are granted. No specific approval is required for items that are described in these Standards. Items that do not conform to these Standards are only allowed by specific approval obtained through a variance request.
- B. Specific approval, as required by these Standards, shall be specifically requested by the Owner/Agent prior to or at the time of submittal of review plans for the project. All specific approval items shall be granted or denied by the Department of Public Works in writing.
- C. Construction work related to any specific approval item should not begin until the Department of Public Works has granted approval in writing. Any work that proceeds without specific approval will be subject to removal and replacement in accordance with these Standards.
- D. Materials and manufactured items used in construction of a Public Works project shall be approved by the Department of Public Works prior to installation. Water and wastewater system appurtenances shall be subject to the approved items as listed in the Approved Products List and City Standard Construction Details available from the Department of Public Works and City website. Items not appearing on the approved list shall not be used for construction of public works facilities in the City of Richmond.

1.10 VARIANCES

- A. Variances from these Standards are authorized only if approved in writing by the City Engineer. Variances must be submitted at the time of the original construction plan submittal. Persons seeking a variance from these Standards shall submit to the Department of Public Works a written variance request application on a form provided by the City with the applicable fee. Variance request applications should be submitted with pertinent information such as construction plans or a right-of-way use permit. Incomplete variance request applications, including applications filed without the payment of the fee, will not be processed until the applicant adequately addresses all outstanding items. It is the applicant's sole responsibility to adequately support all requested variances. The City's standard variance request application form is included at the end of this chapter.

- B. Upon receipt of a variance request application, the City Engineer shall approve or disapprove such application within 10 business days. Construction work related to the variance should not begin prior to approval of a variance. Any construction work related to the variance that proceeds without approval of a variance request shall be subject to removal and replacement at the cost of the party who performs such construction work.



Permitting & Public Works

600 Morton Street
Richmond, Texas
77469

Phone:
281.232.2871
www.richmondtx.gov

VARIATION PROCEDURE

Variation to any technical standard in the infrastructure standards may be permitted by the City if a proposal is submitted by a registered professional engineer following generally accepted engineering standards for traffic, sidewalk and other infrastructure as applicable, and such proposal contains the following information and substantiates the findings in paragraph four (4) below:

PROJECT NAME:

PROJECT ENGINEER:

SUBMITTAL DATE:

RECORDED SUBDIVISION NAME:

This entire form must be submitted complete. If form is submitted incomplete, it will be administratively rejected.

VARIANCE LOCATION:

A proposal must contain the following information and substantiate the findings in paragraph four (4) below:

1. Set forth the proposed deviation to the technical standard.

SPECIFIC PROPOSED DEVIATION FROM TECHNICAL STANDARD:

2. Set forth the impact such deviation has on relative factors such as speed differential and street capacity, the likelihood of accidents, the long term maintenance and operation effect, the degree of functionality and efficiency, the technological advancements involved, and other relevant matters.

IMPACT OF DEVIATION:

3. Show a comparison of the technical standard to the proposed deviation with respect to relative factors such as overall safety and quality, traffic speed differential, street capacity, existing and projected accidents, long-term maintenance and operation, degree of functionality, degree of efficiency, technological advancements, and other relevant matters.

COMPARISON OF TECHNICAL STANDARD TO PROPOSED DEVIATION:

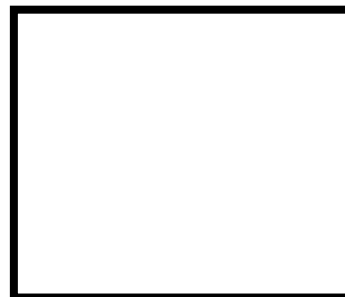
4. Describe all mitigating improvements that reduce the negative impact of the proposed deviation. For example: overall safety and construction quality, traffic speed differential, street capacity, accident occurrences, long-term maintenance and operation, degree of functionality, degree of efficiency and demonstrating the degree to which the proposed deviation detrimentally affects the foregoing. Other relevant factors, including technological advances, should be explained by describing how they will affect the proposed deviation. Mitigating improvements can include, but are not limited to, traffic control devices, pavement improvements, added acceleration or deceleration lanes or reservoirs, and other on-site improvements.

MITIGATING IMPROVEMENTS THAT REDUCE NEGATIVE IMPACT:

SUMMARY & CONCLUSION/RECOMMENDATION FOR VARIANCE:

Supporting Documentation Attached. Yes ___ No ___

Signature and Seal of Professional Engineer:



PERMITTING & PUBLIC WORKS USE ONLY

Reviewed By:

_____ Date

Variance Request Approved / Denied By:

Copies of Backup Information/Notes Attached

_____ Date

END OF CHAPTER



City of Richmond

Design Manual

Chapter 2

SURVEY REQUIREMENTS

CHAPTER 2

SURVEY REQUIREMENTS

2.01 GENERAL:

This chapter describes requirements for the development of construction drawings and right-of-way maps within the city limits and the extra-territorial jurisdiction (ETJ) of the City of Richmond and requirements for all land subdivision projects within the city limits of Richmond and ETJ.

2.02 REFERENCES

- A. Professional Land Surveying Practices Act, latest revision, Occupations Code, Title 6, Ch. 1071.
- B. General Rules of procedures and practices of the Texas Board of Professional Land Surveying, latest revision, Texas Administration Code, Title 22, Part 29, Ch. 661-665.
- C. Manual of Practice for Land Surveying in the State of Texas, latest revision, as promulgated by the Texas Society of Professional Surveying.

2.03 DEFINITIONS

The following definitions shall apply with this chapter:

Data Collection Base - A database printout file reflecting station occupied, backsight, point number, angle, distance, elevations, and identification code; or station and offset left and right from a centerline or control line (transit, baseline, traverse, survey, etc.).

Global Positioning System (GPS) – Navigational System operated by US Department of Defense.

Primary Control Monuments – Monuments that are owned and maintained by the City of Richmond.

Secondary Monuments – Monuments established by developers or contractors for City projects to augment the existing Richmond Site Control Monuments, conforming to the standards established by the City of Richmond.

Survey Field Books - Bound standard engineer's field books for transit and level, 7-1/4 inch by 4-3/4 inch.

2.04 DESIGN REQUIREMENTS

Adhere to the requirements of all applicable sections of this chapter for City of Richmond funded projects or projects under contract to the City of Richmond. Projects within the jurisdiction of the City of

Richmond, but not funded by or under contract to the City, shall be required to follow the requirements of Sections 2.11 and 2.12.

2.05 SUBMITTALS

- A. For work performed through an engineering service contract with the City, deliver an electronic copy of all field books in a “.tif” or “.pdf” format and an electronic file in standard ASCII format (Point Number, Northing, Easting, Elevation, and Description).
- B. Both mylar and electronic copies of all contract deliverables are required. Deliverables for a specific contract will be decided on a case-by-case basis.
- C. For right-of-way drawings identifying or describing acquisition of new or additional rights-of-way, additional documents to be submitted are:
 - 1. Overall map of rights-of-way with individual drawings of the parcels to be acquired and/or new right-of-way identified on overall maps. The overall map and the individual maps shall be on 11” X 17” mylar and shall be signed and sealed by a Texas Registered Professional Land Surveyor. The individual parcels shall be identified by a unique label to enable correlation between the Overall map, individual maps and the metes and bounds description.
 - 2. A Field Note Description (metes and bounds) of all individual parcels.
 - 3. Abstract information and copies of instruments used (i.e., deed) in preparation of the right-of-way maps.
 - 4. Computer printout of parcel coordinate computations and area calculations.
 - 5. An electronic copy of the Overall map and Individual maps in a “.dwg” format compatible with AutoCAD2013 or the current version utilized by the City of Richmond.
 - 6. Other requirements as may be listed in the design contract

2.06 QUALITY ASSURANCE

- A. Field surveying used in the development of construction drawings, calculations and preparation of right-of-way maps, and field note descriptions shall be performed by or under the direct supervision of a Texas Registered Professional Land Surveyor (hereafter known as professional surveyor).
- B. All surveys shall comply with the latest revision of the Professional Land Surveying Practice Act of the State of Texas and the Texas Board of Professional Land Surveying General Rules of Procedures and Practice.
- C. Field notes, descriptions and right-of-way maps shall have the imprinted or embossed seal of the responsible Professional Surveyor and shall be dated and signed by the Professional Surveyor.
- D. All surveyors, when establishing horizontal control, shall transcribe onto the pages of a standard Survey Field Book, all angles, distances and observations, at the time of measurement, with an accompanying sketch. When establishing vertical control, the surveyor shall use differential leveling methods, and transcribe the vertical data onto the pages of said standard Survey Field Book, with an accompanying sketch.

- E. Unless otherwise approved by the City of Richmond, all surveys will meet or exceed the current minimum requirements of the Manual of Practice for Land Surveying in the State of Texas, latest revision, for Category 7, Condition II, Horizontal Control Survey and a Category 8, Condition II, Vertical Control Survey, as promulgated by the Texas Society of Professional Surveying.

2.07 FIELD WORK

- A. For engineering contracts funded by or under contract to the City, fieldwork shall be recorded in field books supplemented with total station database or global positioning system printouts as applicable. All surveys shall be referenced to the City of Richmond Primary Control Monument System unless a specific exemption has been granted.
- B. The horizontal control line must be monumented at its beginning, end, and at angle points with markers of a semi-permanent nature, such as iron rods, spikes, PK or MAG nails or other lasting identification. Make reference drawings for each control monument showing ties to planimetric features to allow easy recovery. Set markers at a maximum of 1,000 feet on long lines.
- C. The existing right-of-way monuments or property corners that are found must be plainly shown on the plans and located by station and distance, right or left from the horizontal control line. Those monuments that were used to determine the control line must be identified as “control points”, and their relationship to the control line and to existing and proposed right-of-way lines must also be shown. Make ties of found right-of-way monuments and property corners to the control line according to the existing Richmond Primary Control Monument System.
- D. For vertical control, set temporary benchmarks (TBM) within 200 feet of the beginning and end of the project and at intervals not to exceed 1,000 feet throughout the project.
- E. Show centerlines and angles of intersections of side streets with the main roadway centerline station.
- F. Record topographic features within the public right-of-way, proposed right-of-way, any contiguous easements to the right-of-way, and any construction right-of-way of the project and on intersecting streets for a distance of 30 feet beyond the intersection of the right-of-way lines. Identify all visible underground structures, such as inlets, manholes, and junction boxes, with size, depth, and type.
- G. Cross sections shall be taken at intervals of no greater than 100 feet, unless otherwise approved by the City. Record elevation of driveways at intersection of driveway centerline with existing or proposed right-of-way line. For levels recorded in field books, record rod readings or elevations as numerator and distance right or left of the base or centerline as the denominator. Data collector of a total station or global positioning system can be used to acquire necessary elevations at required intervals. GPS survey technology will not be approved for use in surveys for any design or construction purposes where vertical accuracy greater than 0.08 feet is required. GPS survey technology and procedures will not be approved for use in establishing vertical control for project benchmarks.
- H. For acquisition of new or additional rights-of-way:

1. Set iron rods or permanent markers at the intersections of the proposed right-of-way and property lines of parcels to be acquired.
2. Identify monuments, corners, angle points, points of curve (PCs), points of intersection (PIs), points of tangency (PTs), and other points as either "found" or "set." Describe each point such as 5/8-inch iron rod, 3/4-inch iron pipe, axle, concrete marker, disk, or other item of permanent nature.
3. Locate improvements, buildings, fences, permanent signs, and other structures within the parcel or within 10 feet of the proposed right-of-way that will influence the value of the parcel to be acquired.

2.08 CALCULATIONS

- A. Calculate coordinates of proposed right-of-way parcels, control points, found or set monuments, curve data, lengths, stations and offsets to monuments, and proposed improvement features. Calculate areas, cross sections, and volumes associated with construction drawings.
- B. Computer printouts of the coordinate calculations should be submitted to the City with field books and database printout files.

2.09 CONSTRUCTION DRAWINGS

- A. Found existing right-of-way monuments or property corners must be plainly shown on the drawings and located by station and distance, right or left from the control line, or construction centerline. Monuments used to establish the control line must be identified as Control Points, and their relationship to the construction centerline and to the proposed or existing right-of-way lines must be shown. If the project is dimensioned from a control line, such as construction or design baseline, which is different than the control line referenced in paragraph 2.07, it must be established and monumented in accordance with the requirements of paragraph 2.07. Coordinates for traverse control points and all points of curve, points of tangency, and points of intersection along the design baseline shall be shown and expressed in grid values to facilitate addition to the City's GIS system.
- B. Show location and identification of existing City survey monuments, right-of-way monuments, and found property corners by station and distance, right or left of control line or design centerline or by bearing and distance to remote points. Show swing ties set for control or centerline control.
- C. Show and identify location of survey monuments and temporary benchmarks used for elevation control. List the TBM located closest to that particular sheet in a station/offset, description and elevation format.
- D. Show centerline angles of intersection of side streets with main roadway centerline. Where bearings are used, identify source of bearings and show bearings on both control line and project centerline when they are not the same line.

- E. Identify locations of manholes, angle points, bends, etc., for proposed wastewater, storm sewers, water lines, and pavement features such as radius returns and centerlines of boulevard openings. Show relationship of proposed improvements to the right-of-way line.
- F. For bridges, overpasses and underpasses show top of pavement elevations at gutter line and centerline for the following locations:
 - 1. Construction joints
 - 2. Armor or expansion joints
 - 3. Intervals between bents that correspond to the increments used for dead load deflection calculations.
- G. For bridges and grade separations, drawings must incorporate layout sheets which identify proposed centerline and curve information plus:
 - 1. Surface coordinates for control points so that an inverse between coordinates reflects a surface distance. Identify origin of coordinate system used.
 - 2. Show coordinates of centerline or control line at PIs.
 - 3. Show coordinates of curb lines at their intersection with the centerline of bents and abutments for irregular structures.

2.10 RIGHT-OF-WAY MAPS

- A. Show true "x," "y" values (i.e., grid) on monuments based on the Texas State Plane Coordinate System control and the scale factor used to determine the "x," "y" values. Distances shown shall be surface distances and plainly marked as such. Show ties to the POC or POB of each right-of-way parcel from the survey monuments using the Texas State Plane Coordinate System bearings and surface distances.
- B. Distances on proposed right-of-way lines shall be continuous from beginning to end of the job. Show either straight line or arc distance across intersecting streets.
- C. Where a parcel is taken from a larger tract, show ownership, dimensions, distances, and area of the remainder of the tract based on record information.
- D. Identify the evidence used to decide the final placement or establishment of the proposed right-of-way line, such as angle points, or corner monuments, as either "set" or "found". The description of each point used shall be shown on the drawing as identified in the field survey.
- E. Coordinate values of "x," "y" shall be shown for PCs, PTs, and PIs of curves on the proposed right-of-way lines. Curve data must include the following: delta, radius, arc length, chord length, and chord bearing.
- F. Coordinate values of "x," "y" must be given on the POB of at least one tract in each block. Where the proposed right-of-way is to be acquired from a large tract of land, coordinate values should be given for the POB of field note description of the large tract.
- G. Other information to be shown on right-of-way maps:

1. Improvements such as buildings, fences, permanent signs, and other structures located on the property or within 10 feet outside the right-of-way line that will influence the value of the parcel to be acquired.
2. Abstract information used in preparation of the right-of-way map.
3. Fort Bend Central Appraisal District identification numbers.

2.11 DOCUMENTS

- A. Where new construction will damage, destroy, or alter existing survey markers, include in the contract specifications a requirement for installation of replacement survey markers by a Texas Registered Professional Land Surveyor.
- B. Maps and metes and bounds shall have the Professional Surveyor's seal imprinted or embossed on them and shall have the Professional Surveyor's signature and date affixed to the instrument.

2.12 SURVEY REQUIREMENTS FOR ALL PROJECTS WITHIN CITY OF RICHMOND

- A. The secondary benchmark horizontal positions shall be certified by a Texas Registered Professional Land Surveyor and shall meet or exceed the current minimum requirements of Category 7, Condition II Horizontal Control Survey as per the Manual of Practice for Land Surveying in the State of Texas, latest revision, as promulgated by the Texas Society of Professional Surveying. All horizontal information shall be referenced to the City Primary Control Monument System, and expressed in grid values to facilitate addition to the City's GIS system.
- B. All secondary benchmark locations shall be referenced to existing monuments of the City Primary Control Monument System, showing a reference line expressed as a bearing in units of degrees, minutes and seconds (DDD mm ss). All distances shall be grid distances expressed in units of feet and all coordinates shall be expressed as grid and referenced to the Texas State Plane Coordinate System, South Central Zone, North American Datum of 1983, current adjustment.
- C. Secondary benchmarks shall be constructed of a brass or aluminum disc, 3-inches in diameter, set in concrete as approved by the City of Richmond. Secondary benchmarks may be permanently mounted in concrete on esplanade bullet noses, headwalls or inlet tops and similar structures.
- D. A separate data sheet shall be drafted clearly identifying the location of the secondary benchmark including a complete description showing at least three (3) references. The data sheet shall show the X and Y coordinates along with the elevation and adjustment data. The X and Y coordinates shall be expressed as true grid coordinates. A sample data sheet is provided at the end of this Chapter. An electronic copy of the data sheet will also be provided to the City. All survey data sheets must be signed and sealed by a registered professional surveyor with contact information listed.
- E. The construction plans shall clearly identify the location of the secondary benchmark to be installed and shall include a complete description, coordinates and elevation, with adjustment data, of the secondary benchmark.

END OF CHAPTER



**Richmond Survey
Secondary Benchmark Monument Sheet**

Survey Marker No. _____

**Include Strip Map/Line Drawing AND
Aerial Photo backdrop or photo
of Marker Location Here
(attach a 2nd page if needed)**

Texas Coordinate System (NAD 1983),
South Central Zone

X=_____ Grid

Y=_____ Grid

X=_____ Surface

Y=_____ Surface

Scale Factor: _____

ON MAP SHEET: _____

North American Vertical Datum of 1988

2001 Adjustment

Elevation: _____

Lat: _____

Long: _____

General Location and Description: _____

Date Set: _____ Type of Marker: _____

Primary Control Monument(s) Referenced: _____

Responsible Surveyor Name: _____

Signature & Seal

NOTES:



City of Richmond

Design Manual

Chapter 3

CONSTRUCTION PLAN REQUIREMENTS

CHAPTER 3

CONSTRUCTION PLAN REQUIREMENTS

3.01 GENERAL

- A. This chapter includes the graphic requirements for engineering drawings submitted for review and permitting to the City of Richmond.
- B. The Richmond City Public Works Department shall approve construction plans for public improvements within the Richmond City limits or extraterritorial jurisdiction.
- C. Construction plans for private improvements, within public rights-of-way and public easements that connect to or affect the public infrastructure shall be approved by the City of Richmond subject to the requirements of this manual and are subject to review and approval using the process defined in this manual.

3.02 DESIGN REQUIREMENTS

- A. Provide a cover sheet for projects involving three or more design drawings (excluding City of Richmond standard construction detail sheets). Drawing sheet numbers and titles shall be listed on the cover sheet. Include an area key map and vicinity map to identify project location. Construction plans shall include a legend describing standard symbols that may not be described in the plans. A City of Richmond approval block shall be provided on both the cover sheet and on the street lighting layout sheet for signatures by the City of Richmond. Drawings shall be prepared on standard drawing sheets of 24" x 36".
- B. All construction plan review submittals shall be accompanied by a cover letter clearly identifying any proposed variance from the Richmond City Design Manual. All variances must be submitted in accordance with the variance procedure set forth in Chapter 1.
- C. The seal, date, and original signature of the Professional Engineer (or other applicable design professional) responsible for the drawings are required on each sheet developed by the design engineer (or other design professional), including construction detail sheets. A stamped seal or embossed imprint may be utilized; however, the embossed imprint must be shaded so that it will reproduce on prints. Street light layouts, only, are exempt from this requirement.
- D. Final design drawings shall be reproducible for City funded projects. Final design drawings shall be reproducible for privately funded projects. Do not use adhesive-backed material on final drawings. Stick-ons may be allowed with approval of the City Engineer for a minor correction during the final review process.
- E. Details of special structures (not covered by approved standard drawings, such as stream or gully crossings, special manholes, or junction boxes) shall be drawn with vertical and horizontal scales equal to each other.
- F. Each set of engineering drawings shall contain paving and utility key drawings indexing specific plan and profile sheets. City Standard Details, where applicable, shall be included. All sheets shall have standard title blocks and borders. All details within the border of City of Richmond

Standard Detail sheets shall be included. If non-applicable details are included on a sheet, the unneeded details shall be crossed out with heavy lines, but shall remain on the sheet.

- G. Resolution of all known conflicts of proposed utilities with existing utilities.
- H. Plan stationing must run from left to right, except for short streets or lines originating from a major intersection, where the full length can be shown on one sheet.
- I. A north arrow is required on all sheets and should be oriented either toward the top or to the right. This requirement is waived under the following conditions:
 - 1. A storm water or sanitary sewer with flow from west to east or from south to north.
 - 2. A primary outfall drainage ditch with flow from west to east or from south to north.
 - 3. Stationing is intended to start from the cardinal points of the compass and proceed in the direction of construction.
- J. Draw key overall layouts to a minimum scale of 1" = 200'. Standard scales permitted for plans and profiles of paving and utility construction drawings are as follows:
 - 1. Major thoroughfares, streets with esplanades over 400 feet in length, or special intersections/situations.
1" = 20' Horizontal, 1" = 2' Vertical
 - 2. Minor or residential single-family streets.
1" = 20' Horizontal, 1" = 2' Vertical
1" = 50' Horizontal, 1" = 5' Vertical, or
1" = 40' Horizontal, 1" = 4' Vertical
 - 3. Scales of paragraph 3.02J.2 above are minimum; larger scales may be used to show details of construction.
 - 4. Deviation from specified scales can only be permitted with the special approval of the City Engineer.
 - 5. Single-banked plan-and-profile drawings are acceptable; double-banked plan-and-profile sheets are allowed in certain situations such as off-site utility lines in undeveloped areas.
- K. All property ownership and easement information will be shown in the construction plans. Fort Bend County recording information shall be shown in the construction plans. When ownership, easement, and right-of-way recording information is not shown on the plat included in the plans, this information will be shown on the construction plan sheets.
- L. A benchmark elevation and description is required on the layout and on all plan and profile sheets. Refer to Chapter 2 of this manual for benchmark datum requirements.
- M. A copy of the approved preliminary plat for new development shall be included with the final design drawings when submitted for final approval.

- N. If a roadway exists where drawings are being prepared to improve or construct new pavement or a utility, label the existing roadway width, thickness, and surface type, if available, without destruction of pavement. Pavement thickness can be ascertained by coring. When complete the core hole shall be grout filled immediately after completion to protect pavement prior to construction.
- O. Develop drawings to accurate scale showing proposed pavement, typical cross sections, details, lines and grades, and existing topography within street right-of-way, and any easement contiguous with the right-of-way. At the intersection, the cross street details shall be shown at sufficient distance (20-foot minimum distance outside the primary roadway right-of-way) in each direction along cross street for designing adequate street crossings. Show all street and road alignments on drawings.
- P. Match lines between plan and profile sheets shall not be placed or shown within cross street intersections including cross street right-of-way. Match lines shall be provided and clearly labeled in a consistent manner when more than one plan and profile sheet is required. When more than three plan and profile sheets are provided, an additional match line index sheet shall be provided.
- Q. Show natural ground profiles as follows:
1. For privately-funded projects, centerline profiles are satisfactory except where a difference of 0.50 feet or more exists from one right-of-way or easement line to the other, in which case, dual profiles are required.
 2. For City projects, provide natural ground profiles for each right-of-way line. Easement profiles shall conform to paragraph 3.02R.1.
 3. A survey plan must be included to show predevelopment contour lines and grades, signed and sealed by a registered professional surveyor.
 4. Site plan must show existing and proposed grades, drainage patterns shown in arrows and changes in any natural landscape features on site. Line work must allow a clear and easily distinguished comparison between existing and proposed features.
- R. Basic plan and profile sheets shall contain the following information:
1. Identify lot lines, property lines, easements, rights-of-way, and drainage outfalls.
 2. Label each plan sheet as to street pavement and right-of-way widths, easement widths, pavement thickness where applicable, type of roadway materials, curbs, intersection radii, curve data, stationing, existing utilities (type and location), proposed utilities (type and location), all bedding requirements, all pipe sizes and type and any other pertinent feature affecting design.
 3. Show utility lines 4 inches (4") in diameter or larger within the right-of-way or construction easement in profile view. Show utility lines, regardless of size, in the plan view, including fiber optic cables. Show any utility crossing, label available clearance, and illustrate proposed casing per standards in Chapters 5 and 6 of this manual.
 4. Show flow line elevations and direction of flow for existing ditches. Show storm sewer information as required per standards in Chapter 7 of this manual.

5. Label proposed top of curb grades except at railroad crossings. Centerline grades are acceptable only for paving without curb and gutters.
 6. Show, in profile, curb returns elevations, grades for turnouts and manhole elevations.
 7. Gutter elevations are required for vertical curves, where a railroad track is crossed.
 8. Show in profile the centerline elevation at the property line of existing driveways.
 9. Station existing and proposed esplanade noses and show the centerline of esplanade openings and esplanade width.
 10. The design of both roadways is required on paving sections with an esplanade.
 11. Show and/or station, in plan view, points of curvature, points of tangency, and radius returns. Show and/or station, in profile, radius returns and grade change points of inflection with their respective elevations.
 12. Show the required sight distance triangle at all intersections on major thoroughfares and major collectors and intersections of other streets with adjacent community fencing, monument signs or hardscaping.
- S. Construction plan review submittals shall include a signed and sealed copy of the relevant Geotechnical Report.
- T. Construction plan review submittals shall include a signed and sealed copy of traffic analysis report as warranted, if one has not been submitted during a prior development phase and determined to be necessary at the discretion of the City Engineer.
- U. Construction plan review submittals shall include a signed and sealed copy of drainage analysis report to provide background data and information needed to support design calculations.
- V. Construction plan review submittals shall include a signed and sealed copy of the water and wastewater design analysis report to provide background data and information needed to support the design.

3.03 MINIMUM REQUIRED PLAN SHEETS

The following plan sheets are required for all Public Works Projects within Richmond:

1. Cover Sheet
2. Subdivision plat
3. Construction notes and legend.
4. Overall plans (W, S & D and paving) for proposed improvements.
5. Drainage area map, if applicable.
6. Lot grading plan that includes a detail of a typical graded lot, if applicable.
7. Street light layout, overall traffic signage, and street sign layout, if applicable. (Street light layouts shall be submitted in accordance with Chapter 4)

8. Plan and profiles of all public right-of-ways and easements.
9. Specific construction details.
10. Detour and traffic control layout, if necessary.
11. City of Richmond Public Works standard construction details.
12. Storm Water Pollution Prevention Plan (SWPPP) and associated detail sheets and/or specifications.

These are the minimum plan sheets required. The order of assembly should be logical and made by the Engineer.

3.04 GRAPHIC STANDARDS

- A. Construction plans for public improvements shall follow the graphic standards and electronic drawing layering requirements specified in Chapter 16.
- B. Existing Improvements: Existing improvements are required for depicting existing improvements on base drawings.
- C. Proposed Improvements: Proposed improvements are required for depicting proposed improvements on base drawings.
- D. Signature Block: Construction plans for public improvements shall contain a Signature Block for approval for the Director of Public Works and for the City Engineer. Signature Blocks shall include the statement, "Approval void if progress has not been made toward completion of project within five (5) years of date of signature."
- E. Signature Block: Construction plans for public improvements shall contain a Signature Block for approval for the Director of Public Works and for the City Engineer. Signature Blocks shall include the statement, "Approval void if progress has not been made toward completion of project within two years of date of signature."

END OF CHAPTER



City of Richmond

Design Manual

Chapter 4

STREET LIGHTING AND OVERHEAD UTILITIES

CHAPTER 4

STREET LIGHTING & OVERHEAD UTILITIES

4.01 GENERAL

- A. This chapter includes the installation and design requirements for street lighting and the placement of overhead utility lines within the city limits and the extra-territorial jurisdiction of the City of Richmond.
- B. The Richmond Public Works Department shall approve street lighting plans for all public improvements within the Richmond city limits or extraterritorial jurisdiction.
- C. Construction plans for private improvements, within public right-of-ways and public easements that connect to or affect the public infrastructure shall be approved by the City of Richmond subject to the requirements of this manual and are subject to review and approval using the process defined in this manual. Private streets with the same general geometric cross-section as a public street shall be required to have street lighting in conformance with this manual.
- D. The purpose of this chapter is to provide motor vehicle drivers with quick, accurate and comfortable vision at night, taking into consideration the need to provide lighting in an economically feasible manner that is consistent, safe, and compatible with surrounding land use.

4.02 DESIGN REQUIREMENTS

- A. Street lighting plans shall be included within the design drawings for all residential land development projects. Commercial land development projects that include the construction of public or private roadways shall include a street light plan for the roadway. A City of Richmond approval block shall be provided on both the cover sheet and on the street lighting layout sheet for signatures by the City of Richmond.
- B. Street lighting plans shall conform to the technical requirements of this chapter and any approved variances to the technical requirements.
- C. Drawings shall be prepared nominal 24" x 36" drawing sheets, as appropriate.
- D. The firm/agency and original signature of the design professional responsible for the street light plan are required on each sheet.
- E. Final design drawings shall be permanent ink on mylar, or produced by CADD on mylar for City funded projects. Final design drawings shall be reproducible for privately funded projects. Do not use adhesive-backed material on final drawings.
- F. Details of special structures (i.e. street light bases) shall be drawn with vertical and horizontal scales equal to each other.
- G. All "cobra head" street lights shall be installed with cut-off fixtures to minimize light pollution.
- H. All plats shall include a commitment for the installation of street lights in accordance with the

terms of this chapter. This commitment shall include a separate letter identifying the number and wattage/lumens of lights to be installed as required by this chapter. A separate street light installation plan shall be approved by the Department of Public Works. Street lights shall be installed prior to the end of the one-year maintenance period and/or prior to the permitting of private improvements. A copy of the approved street light plan shall be included in the project closeout documents.

4.03 RESPONSIBILITY FOR INSTALLATION AND MAINTENANCE IN EXISTING DEVELOPMENTS

- A. Existing developments are those developments where formal application for City approval, usually in the form of submittal of a set of construction plans, has been made as of the date of final adoption of this Chapter, or those developments that are already in existence at the time of adoption of this Chapter regardless of whether City approval was given, to the extent such development is already in place or to the extent application for City approval has already been made.
- B. Installation and maintenance of street lights by the City in existing developments shall be contingent upon the average daily traffic count, stage of development, street design, existing illumination levels and budgeted funds.
- C. In no case shall the standards in this Chapter be interpreted to mean that existing street lights already installed or proposed in existing developments be removed, relocated, or otherwise changed unless the current street light layout of an existing development is to be substantially altered from the condition in place at the time of the adoption of this policy. In such instances, the new layout will conform to the technical standards set forth in this policy.
- D. In existing residential and commercial developments where street lights are installed or proposed to be installed throughout the development, or a section thereof, by the developer or homeowners association (HOA) of the development or section, the developer or HOA shall maintain and ensure the proper illumination in accordance with this policy of the street lighting, including paying of the installation and the monthly utility cost therefore, until 80% of the land area is built out as reflected by the City's tax rolls, or for a period of three years after the initial use of the street lights, whichever occurs first. Thereafter, it shall be the responsibility of the City to maintain the street lights in a manner consistent with this policy.
- E. In existing residential and commercial developments or sections thereof, where street lights have not been installed nor are proposed to be installed by the developer or HOA, the City may opt to provide for the installation and maintenance of street lighting, including ensuring the proper illumination thereof and paying the monthly utility costs beginning the fourth year following final plat or plan approval, or after 80% of the land area is built out as reflected by the City's tax rolls, whichever occurs first.
- F. Notwithstanding anything to the contrary herein regarding existing developments, along existing major thoroughfares or a portion thereof where street lights have not been installed nor are proposed to be installed, the City shall provide for the installation and maintenance of street lights, including proper illumination and paying the monthly utility costs therefore, when the average daily traffic count, stage of development, street design, existing illumination levels and budgeted funds allow for same, as determined by the City.

4.04 RESPONSIBILITY FOR INSTALLATION AND MAINTENANCE IN NEW DEVELOPMENTS

- A. New developments are those developments where formal application for City approval or conditional approval, usually in the form of submission of a preliminary plat or a conceptual plan, has not been made as of the date of adoption of this chapter. The developer shall include a street light layout plan, conforming to the provisions of this policy, with the construction plans submitted for approval by the City.
- B. In all new residential and commercial developments, the developer shall be responsible for the installation and maintenance, including the proper illumination, of street lights along all streets or portions of streets. Such maintenance includes the payment of all utility charges for the operation and maintenance of street lights, and such utility charges shall be paid directly to the electrical service provider serving the street lights. Such street light installation and maintenance period shall be from prior to the end of the one (1) year maintenance period for the streets and continue until 80% of the platted lots are built out, as reflected by the City tax rolls, or for a period of three years from the acceptance of the streets for permanent maintenance by the City, whichever occurs first. Thereafter, it shall be the responsibility of the City to maintain street lights in new residential developments and new commercial developments in a manner consistent with this policy.
- C. Notwithstanding anything to the contrary herein regarding new developments, the developer of property adjacent to a major thoroughfare or of property within which all or a portion of a major thoroughfare is situated or proposed, shall be responsible for the installation and maintenance, including ensuring the proper illumination, of street lights along the major thoroughfare for the length of the major thoroughfare along which the development is situated. When a developer develops only on one side of a major thoroughfare, he is required to install and maintain approximately half of the number of street lights required for said length of thoroughfare. The responsibility to install and maintain street lights as set forth herein by the developer continues until the end of the one-year street maintenance period. During that time, the monthly utility charge for the street lights is the responsibility of the developer, and is paid directly to the retail electric provider. Thereafter, it is the responsibility of the City to maintain street lights along the major thoroughfare or portion thereof in a manner consistent with this policy.

4.05 ORNAMENTAL STREET LIGHTS

- A. To the extent that street lighting is designed to exceed and/or deviate from these Standards, it shall be considered ornamental lighting. Ornamental lighting shall be allowed as a variance from these Standards in accordance with Section 1.10 hereof. In no event shall the street lighting layout and design be below the standards set forth in this Chapter, nor exceed the standards set by the Illuminating Engineering Society. If the cost for installing and/or maintaining such ornamental lights exceeds the cost for lights installed in accordance with the City standards, the costs above the City standard shall be paid in perpetuity by the developer, homeowner association, or property owner association, under contract directly with the service provider. A written agreement between the developer, homeowner association, or property owner association and the electrical service provider must be submitted prior to the issuance of a construction permit.
- B. The city standard for street lights on curb-and-gutter streets and in new developments is the

“cobra head” street light mounted on a smooth, 35-foot or 40-foot metal pole. In areas where wooden poles and overhead lines are already prevalent, street lights may be located on existing wooden poles. Street lights that are not “cobra head” lights or that are not mounted above 30 feet are considered ornamental street lights.

- C. The installation, operation and maintenance of ornamental street lights shall not be the responsibility of the City of Richmond.

4.06 TECHNICAL REQUIREMENTS

4.06.1 Street Light Spacing

- A. In residential developments, not along major thoroughfares, where home sites are located on an average of less than every 100 linear feet, street lights shall be evenly spaced and located on an average of 350 feet apart from one another. In no event shall street lights be installed so that they are closer than 200 feet or further than 500 feet apart from one another unless an intersection, major thoroughfare, or bridge necessitated spacing less than the 200 foot minimum.
- B. In residential developments, not along major thoroughfares where home sites are platted on an average of one every 100 linear feet of street or more, street lights shall be evenly spaced and located on an average of 500 feet apart. In no event shall street lights be installed so that they are closer than 300 feet or further than 700 feet apart from one another unless an intersection, major thoroughfare, or bridge necessitated spacing less than the 300 foot minimum.
- C. Lights shall not be installed on cul-de-sacs unless the cul-de-sac is at least 150 feet long. Lights in cul-de-sacs shall be located in accordance with Section 4.06.1A and 1B.
- D. In commercial/industrial developments not along major thoroughfares where buildings are located on an average of less than every 375 linear feet, street lights shall be evenly spaced and located on an average of 450 feet apart. In no event shall street lights be installed so that they are closer than 300 feet or further than 600 feet apart from one another unless an intersection, major thoroughfare, or bridge necessitated spacing less than the 300 foot minimum.
- E. In commercial/industrial developments not along major thoroughfares where buildings are located on an average of one every 375 linear feet of street or more, street lights shall be evenly spaced and located on an average of 700 feet apart unless an intersection, major thoroughfare, or bridge is located closer than that. In no event shall street lights be installed so that they are closer than 400 feet or further than 1,000 feet apart from one another unless an intersection, major thoroughfare, or bridge necessitated spacing less than the 300 foot minimum.
- F. Along major thoroughfares with esplanades, lights shall be installed on double-arm standards within the esplanade on an average of 400 linear feet apart. A standard will be required within 100 feet of all intersections and median openings. In no event shall street lights be installed so that they are closer than 300 feet or further than 700 feet apart from one another unless an intersection, major thoroughfare, or bridge necessitated spacing less than the 300 foot minimum.

- G. Along major thoroughfares without esplanades, lights shall be on single-arm standards staggered along each side of the roadway at an average of 400 linear feet apart on each side of the roadway. A standard will be required within 100 feet of all intersections and median openings. In no event shall street lights be installed so that they are closer than 300 feet or further than 700 feet apart from one another unless an intersection, major thoroughfare, or bridge necessitated spacing less than the 300 foot minimum.
- H. Notwithstanding any provision herein to the contrary regarding street light spacing, street lighting shall be installed at every street intersection. Street lights at intersections on major thoroughfares will be located so as to illuminate the major thoroughfare and not turned to illuminate the minor street.
- I. A street light will be required to be installed on the approach lane, on each side, of all bridges unless a 9,500 lumen light or greater is located within 100 feet of the bridge approach, in which case an additional street light will not be required.

4.06.2 Street Light Lumen Size

- A. The lumen size of street lights required to be installed will be in accordance with the following:
 - 1. Residential Developments (not on major thoroughfares). In residential developments, not on major thoroughfares, 9,500 lumen street lights shall be installed.
 - 2. Commercial/Industrial Developments (not on major thoroughfares). In commercial/industrial developments not on major thoroughfares, a 9,500 lumen light shall be installed at all street intersections, 9,500 lumen lights shall be installed at all median openings and 9,500 lumen lights shall be installed for all other required street lights.
 - 3. Major Thoroughfares. Along major thoroughfares 16,000 lumen lights shall be installed with the following number of lights at intersections.
 - i. At the intersection of two major thoroughfares, two 16,000 lumen lights shall be installed.
 - ii. At the intersection of a major thoroughfare and a non-major thoroughfare street, one 16,000 lumen light shall be installed.

4.06.3 Street Light Poles

- A. Metal or concrete poles will be used in residential developments.
- B. In commercial/industrial developments, metal poles are required; where wood poles and overhead wires are already prevalent, wood poles will be used for street lights.

4.07 SPECIAL CONDITIONS

- A. From time to time special conditions may exist that render it necessary to alter the lumen size,

spacing requirement, or other technical standards to adequately meet the objectives of this policy. Such special conditions shall include, but not necessarily be limited to, the following:

1. In new construction of developments and major thoroughfares, the developer may be required to install lights in excess of the standards set forth in this Chapter to lessen traffic and safety hazards existing because of certain site conditions which prevent the technical standards from providing sufficient lighting for traffic safety, as determined by the City Engineer. These conditions include, but are not limited to, pavement type, number of interchanges, street design, ratio of night to day accidents, and other relevant matters.
2. Wherever the City may deem it necessary or desirable, the City may elect to be responsible for the installation and maintenance of street lighting in excess of policy standards to lessen traffic and safety hazards or otherwise alter existing conditions.

4.08 OVERHEAD UTILITY PLACEMENT

- A. Overhead utility lines shall be routed so that their visual impact is minimized.
- B. New utility lines shall be placed either underground or in easements along rear property lines.
- C. Development of subdivisions that include pad sites or out tracts shall plan and provide either for off-street or underground service to those pad sites or out tracts.
- D. Overhead utility street crossings shall be approved by the City and shall not include wooden poles within the public right-of-way.
- E. New overhead utility lines are not allowed to run parallel to public streets, within the public right-of-way.

END OF CHAPTER



City of Richmond

Design Manual

Chapter 5

WATER DISTRIBUTION SYSTEMS

CHAPTER 5

WATER DISTRIBUTION SYSTEM

5.01 GENERAL

- A. This chapter includes the minimum design requirements for public and private water distribution systems within the city limits and the extra-territorial jurisdiction of the City of Richmond.
- B. The Richmond Public Works Department shall approve water distribution plans for all public improvements within the Richmond city limits or extraterritorial jurisdiction. Construction shall conform to the City of Richmond Construction Details.
- C. Construction plans for private improvements, within public rights-of-way and public easements that connect to or affect the public infrastructure shall be approved by the City of Richmond subject to the requirements of this manual and are subject to review and approval using the process defined in this manual.
- D. Construction and sizing of all water mains and appurtenances shall meet or exceed the requirements of the Texas Commission on Environmental Quality and the Texas Department of Health.
- E. The Public Water System shall not extend beyond the water meter. All construction to the meter shall conform to the requirements of this manual. All construction beyond the meter is considered private and shall conform to the requirements of the City of Richmond Plumbing Code.
- F. All proposed water distribution systems and interconnects between separate systems and/or utility districts, shall be approved by the City of Richmond Public Works Department.

5.02 DESIGN REQUIREMENTS

- A. Public water distribution systems shall be designed to handle the necessary water flow based upon complete development. The necessary water flow shall include applicable residential and non-residential uses and fire protection flows.
- B. The water system shall be designed to deliver peak-hour demand flows. The fire flow must be available above the peak hour demand of the system and for a duration and at the residual pressure as specified by the Fire Marshal.
- C. One (1) copy and one (1) electronic copy in Adobe Acrobat (.pdf) format of the system hydraulic calculations, sealed by a Texas Registered Professional Engineer, shall be provided with all water distribution system plans. These calculations shall show how the water flow rates were computed, design assumptions and that fire flow requirements are met. If the proposed water distribution system is connecting to an existing system, verification of the flow rates and pressure in the existing system, both before and after

inclusion of the new system, shall be provided by the design engineer and approved by the City Engineer.

- D. Fire flow requirements are based upon International Fire Code, as amended in the Code of Ordinances, latest adopted edition. A reduction in required fire flow of 50 percent to a building is allowed when the building is provided with an approved automatic sprinkler system. The fire flow requirements (at 20 psi residual pressure) include:
 - 1. Residential zoning districts which include one- and two-family dwellings having a fire-flow calculation area which does not exceed 3,600 square feet require a minimum of 1,000 gallons per minute from a single node (fire hydrant).
 - 2. All other zoning districts and uses require fire flows in accordance with the International Fire Code, as amended in the Code of Ordinances, latest adopted edition
- E. Layout of the overall water system and of all water mains within the city limits and extraterritorial jurisdiction shall be approved by the City Engineer. The overall water system shall be designed to maintain adequate pressure throughout the system. In all cases, specific water pressure and flow analysis and study shall be required. The layout of the water mains should provide maximum circulation of water to prevent future problems of odor, taste, or color due to stagnant water.
- F. Provide adequate circulation and place valves and fire hydrants, so that flushing of all mains will be simplified.
- G. Dead-ends shall be avoided where possible. All dead-ends shall be isolated with a line valve, be as short as possible, and be equipped with a fire hydrant or blow off at the end of the main as required in Section 5.03.
- H. In unavoidable permanent dead-end situations, reduce the sizes of pipe successively. Carry a six-inch (6") pipe to the last fire hydrant, then use four-inch (4") PVC to the end of the line. Provide a standard two-inch (2") blow off at the end of the main. Permanent dead-end lines shall not exceed four hundred feet (400') in length.
- I. Where a water main is stubbed out for future extensions, place a valve to isolate the dead-end and restrain the water main to prevent line separation. No customer services shall be located on the dead-end until it is extended. Provide a standard two-inch (2") blow off at the end of the dead-end.

5.03 SYSTEM LAYOUT AND PLACEMENT

- A. Water system layout and placement requirements are established based on land uses, as established in this section. These layout and placement requirements are intended to be minimum requirements; larger mains, shorter runs or additional looping may be required based upon fire flow calculations. If a property is not covered within the development types listed, the City Engineer shall designate the type of development.
 - 1. Type A Development is single family residential.

2. Type B Development is non-residential and multi-family.

B. Water mains in Type A Development shall have a minimum size as follows:

1. Two-inch (2") mains may serve a maximum of six (6) domestic, residential service connections. Two-inch (2") mains shall not exceed two hundred feet (200') in length and shall be installed with a blow off at the end of the line. All two-inch (2") mains shall be specifically approved by the City Engineer.
2. Four-inch (4") mains may serve a maximum of twenty (20) lots when supported on both ends by a larger main. A dead-end four inch (4") main may supply a maximum of ten (10) lots, shall not exceed four hundred feet (400') long and shall be terminated with a blow off. Fire hydrants are not allowed on a four inch (4") main.
3. Six-inch (6") mains shall be a maximum of one thousand five hundred feet (1,500') long when supported on both ends by eight-inch (8") mains or larger and shall have no more than two (2) intermediate fire hydrants. Dead end six inch (6") mains shall not be more than four hundred feet (400') in length and shall terminate at a fire hydrant.
4. Eight-inch (8") mains are required for mains over one thousand five hundred feet (1,500') long, or when three (3) or more intermediate fire hydrants are required. Eight-inch (8") mains shall not be dead end, except as provided in Section 5.02.
5. Twelve-inch (12") and larger mains will be required at locations established by the City Engineer and/or as determined by the design model.

C. Water mains in Type B Developments shall have a minimum sizing as follows:

1. Minimum size of mains shall be eight-inch (8"). Maximum length of a dead-end eight-inch (8") main shall be three hundred fifty feet (350'). A dead-end main shall be terminated with a fire hydrant.
2. Twelve-inch (12") and larger mains will be required at locations established by the City Engineer and/or as determined by the design model.
3. Six-inch (6") fire hydrant leads will not exceed two hundred feet (200') in length.

D. The length of a dead-end water main shall be measured from the intersection with a multiple feed (looped) main to the end of the main. The allowable length of a dead-end main with multiple sizes shall not exceed the allowable length of the smallest main as required in Sections 5.02 (H).

E. Water mains and appurtenances are not allowed in the following sizes: three-inch (3"), ten-inch (10"), and fourteen-inch (14").

5.04 FIRE HYDRANTS (FLUSHING VALVES)

- A. Fire hydrants shall have three-way nozzle arrangement, five and one-quarter-inch (5-1/4") compression type main valve, mechanical joint boot, and conform to the requirements of AWWA C502. Approved fire hydrants and nozzle sizes shall be listed on the Approved Products List.
- B. Fire hydrant spacing shall be measured along the length of the main. Fire hydrants shall be spaced along all mains six-inches (6") and larger as follows:
 - 1. Type A Development – Five Hundred Foot (500') spacing or as designated by the Fire Marshal.
 - 2. Type B Development – Three Hundred Foot (300') Spacing and at all street intersections or as designated by the Fire Marshal.
- C. Location - fire hydrants or flushing valves shall be located as follows:
 - 1. Fire hydrants shall be located three feet (3') behind the back of curb or projected future curb and be set at the point of curvature (PC) of the intersection curb radius. A parallel tee may be used for a fire hydrant lead at the water main. To the maximum extent practical, fire hydrants shall be located on lot lines.
 - 2. On all open-ditch roadways, set the fire hydrants or flushing valves within one foot (1') of the right-of-way. Fire hydrants shall not be located between the edge-of-pavement and the open ditch. Fire Hydrant locations on open-ditch roadways are subject to the approval of the City Engineer
 - 3. Fire hydrants located between right-of-way intersections should be set at a lot line, however, this location may be adjusted five feet (5') either way to miss driveways or other obstructions, in which case the fire hydrants should not be closer than three feet (3') from curbed driveways or five feet (5') from non-curbed driveways.
 - 4. Fire hydrants may be located in the esplanade section of City streets only when it is not feasible to locate them between the right-of-way line and the back of curb and with specific approval from the City Engineer. In such case, it is preferable to locate the fire hydrants twelve feet (12') behind the esplanade back of curb to provide access for parkway mowers and future street widening; but in no instance shall they be located closer than three feet (3') from the esplanade back of curb or five feet (5') from the esplanade edge of pavement.
- D. All fire hydrants shall be located in protected, but easily accessible, areas behind the pavement.
- E. The depth of bury for all fire hydrants shall be established such that the manufacturer bury line on the fire hydrant is installed at the ground line at each location or at the finished ground after pavement construction.
- F. Fire hydrants shall not be installed within nine feet (9') of a sanitary sewer system under any conditions.
- G. The body of the fire hydrant shall be factory painted Gray two part Polyurethane Enamel.

All paints shall conform to the City of Richmond Fire Hydrant Color Code. Fire hydrants shall be color coded on the fire hydrant bonnet and caps based upon mainline size. The paint utilized shall be a two part Polyurethane Enamel or approved equal and installed in accordance with the manufacturer's instructions. The color code shall be as follows:

Color	Water Main Diameter (in.)	Polyurethane Enamel
Yellow	6" and less	Safety Yellow
White	8"	Safety White
Green	10" to 20"	Safety Green
Orange	24" to 60"	Safety Orange

- H. All fire hydrants shall be installed so that the steamer connection will face the fire lane or street or as directed by the Fire Marshal.
- I. Fire hydrants, when placed at intersections or access drives to parking lots, when practical, shall be placed so that no part of the fire truck will block the intersection or parking lot access when connections to the fire hydrant are made.
- J. A Blue Stimsonite, Fire-Lite reflector model 88-SSA (or approved equal) shall be placed 12 inches (12") from the centerline of the street, offset towards the fire hydrant. At intersections, reflectors shall be placed on both roadways opposite fire hydrant.

5.05 WATER DISTRIBUTION SYSTEM MATERIALS

- A. All materials used in the construction of public water distribution systems must be in conformance with American Water Works Association (AWWA) and NSF International guidelines.
- B. Poly Vinyl Chloride (PVC) Pressure Pipe, two-inch (2") through twelve-inch (12"), shall conform to the requirements of ANSI/AWWA C900, current revision, Class 150 DR 18. Pipe shall be designed and constructed in conformance with the minimum requirements of the "Manual of Water Supply Practices", AWWA Manual No. M23. PVC pipe with the use of ductile iron fittings is the preferred material for water line construction. The use of ductile iron pipe is allowed as necessary.
- C. Ductile-Iron Pipe (D.I.P.), four-inch (4") through fifty-four-inch (54"), shall conform to the requirements of "Ductile-Iron Pipe, Centrifugally Cast in Metal Molds for Sand-Lined Molds, for Water and Other Liquids", AWWA C151, (ANSI A21.51), current revision. Pipe thickness shall be the minimum specified in C151. Under special conditions, the City Engineer may require thickness design in conformance with the minimum requirements of "Thickness Design for Ductile-Iron Pipe", AWWA C150 (ANSI A21.51), current revision. Pipe shall be installed in conformance with the minimum requirements of AWWA C600, "Installation of Gray and Ductile Cast-Iron Water Mains and Appurtenances". Ductile-Iron Pipe shall be furnished with epoxy or

cement mortar lining, AWWA C104 (ANSI A21.4). Polyethylene tube encasement shall be provided as required.

- D. Other pipe materials may be used for construction of water mains, when specifically approved by the City Engineer.
- E. Bedding and backfill shall conform to the City of Richmond Standard Construction Details.
- F. Alternate materials may be used only with specific approval from the City Engineer.
- G. Construction of water mains shall be in accordance with approved construction plans and the City of Richmond Standard Construction Details.

5.06 LOCATION OF WATER MAINS AND EASEMENT REQUIREMENTS

- A. All public water mains shall be installed within a water line or public utility easement or right-of-way. Water mains within the right-of-way shall be located a minimum of four feet (4') from back of curb whenever possible. A minimum of four feet of cover shall be maintained at all times, except as allowed by Section 5.08.
- B. Water mains shall be placed along a uniform alignment with the right-of-way. When necessary, the water main may be deflected at a fire hydrant location to accommodate proper installation of the fire hydrant. At all locations where a water main changes alignment, the location of the water main shall be clearly shown on the construction plans. A minimum distance of two feet (2') shall be maintained from the right-of-way line to the nearest outside edge of the water line.
- C. For new construction, any water main, except at a fire hydrant, located less than five feet (5') from the road right-of-way line and within the right-of-way shall have a water line easement adjoining the right-of-way. Water line easements adjoining a right-of-way for mains smaller than twelve inches (12") shall have a minimum width of five feet (5'). For mains greater than twelve inches (12") in diameter, the easement adjoining the right-of-way shall have a minimum width of ten feet (10').
- D. Along streets with open ditch drainage, all water mains shall be located five feet (5') from the right-of-way line.
- E. Water mains shall be located at the center of a ten-foot (10') water line easement, provided the easement adjoins a public right-of-way.
- F. Location of a water main in an easement not adjoining a public right-of-way shall be prohibited, except as specifically approved by the City Engineer. When approved, these water mains shall be centered in a sixteen foot (16') wide exclusive easement or reserve restricted to water only. Water line easements, not adjacent to a public right-of-way, in excess of five hundred feet (500') long shall be twenty feet (20') in width. No fencing or other restrictions limiting access to the full width of the easement or reserve will be allowed.
- G. The following minimum width easements are required when facilities are not located

within public street rights-of-way or water line easements:

1. Fire hydrants located outside of public rights-of-way or water line easements shall be encompassed by a ten-foot by ten-foot (10' X 10') exclusive, easement. Fire hydrants shall not be located within any other type of easements.
2. Water meter easements shall be exclusive, should be located adjoining a public right-of-way or water line easement and shall not overlap other easements, except to cross the easements.
 - a. Two-inch (2") and smaller meters serving non-residential and multi-family developments shall be set in five-foot by five-foot (5' X 5') exclusive water meter easements.
 - b. Four-inch (4") and larger meters shall be set in a minimum of ten-foot by twenty-foot (10' X 20') exclusive, water meter easements.

5.07 CLEARANCE OF WATER LINES FROM OTHER UTILITIES

- A. Water mains shall be designed and located to conform to regulations of the Texas Commission on Environmental Quality.
- B. For water mains crossing an existing or proposed sanitary sewer or force main, the following clearances shall be provided for protection from contamination. The minimum clearances will be approved only when justified and field conditions so dictate. The latest edition of "Rules and Regulations for Public Water Systems", of the Texas Commission on Environmental Quality, shall be followed for minimum criteria and instructions for water line crossings.

5.08 DEPTH OF COVER

- A. Minimum depth of cover for water mains shall be as follows:
 1. Twelve-inch (12") and smaller mains shall have a minimum cover of four feet (4') from the top of curb. At utility conflicts the water main cover may be reduced to three (3) feet with the approval of the City Engineer. For open ditch roadway sections, twelve-inch (12") and smaller mains shall be installed at least three feet (3') below the ultimate flow line of ditch or six feet (6') below natural ground at the right-of-way line, whichever is deeper.
 2. Sixteen-inch (16") and larger mains shall have a minimum cover of four feet (4') from the top of curb. For open ditch roadway sections, sixteen-inch (16") and larger mains shall be installed at least three feet (3') below the flow line of ditch or five feet (5') below natural ground at the right-of-way line, whichever is deeper.
 3. Water mains shall be located in a manner that minimizes the impact on adjacent facilities/infrastructure and allows for ease of maintenance of the water line.
- B. Changes in grade to clear other utilities or underground features may be made by deflecting pipe joints. The maximum designed deflection shall be one-half (1/2) of

manufacturers allowable deflection. If a depth greater than twelve feet (12') to the top of pipe is required, ductile iron pipe shall be used. The standard depth of cover maintained on the water main and the grade change shall be made using ductile iron pipe. The vertical realignment shall be restrained in each direction per restraint requirements and be constructed with mechanical joint fittings and restraints. Any bell joints located in the vertical realignment shall also be restrained.

5.09 BEDDING AND BACKFILL REQUIREMENTS

- A. All bedding and backfill shall be in accordance with the City of Richmond Standard Construction Details. All backfill within public right-of-ways and public easements shall be compacted to a minimum of ninety-five percent (95%) of Standard Proctor Density (ASTM D2922-78 and ASTM D3017-78), without additional moisture control, cured and tested in accordance with ASTM C31.
- B. All water lines located underneath and within one foot (1') of any paving shall be backfilled with cement stabilized sand in accordance with the Standard Construction Details. The cement stabilized sand shall be in accordance with the following requirements.
 - 1. The cement shall be Portland Cement, Type I, ASTM C150.
 - 2. The sand shall be clean, durable sand, with less than 0.5 percent clay lumps, ASTM C142; with less than 0.5 percent lightweight pieces, ASTM C123; with organic impurities, ASTM C40, not showing a color darker than standard color and a plasticity index of less than six (6) when tested in accordance with ASTM D423 and ASTM D424.
 - 3. Compact to ninety-five percent (95%) Standard Proctor Density (ASTM D2922-78 and ASTM D3017-78) in maximum loose lifts of eight inches (8") thick. Actual testing shall be required as deemed necessary by the City of Richmond.
 - 4. The cement-sand mixture shall consist of at least 2.0 sacks of cement -per ton of sand. The cement-sand mixture shall have a minimum unconfined compressive strength of one hundred pounds per square inch (100 psi) in forty-eight (48) hours, when compacted to a minimum of ninety-five percent (95%) of Standard Proctor Density (ASTM D2922-78 and ASTM D3017-78), without additional moisture control, cured and tested in accordance with ASTM C31.
- C. Water lines outside of paving shall be bedded in accordance with the Standard Construction Details.

5.10 VALVES

- A. All water system valves shall conform with AWWA standards and shall be designed as follows:
 - 1. Three inch (3") through eighteen-inch (18") valves shall be resilient seated gate valves, AWWA C509, counterclockwise opening with mechanical joints (MJ).

Valves shall have a complete epoxy coating on all iron parts in the valve interior to eliminate corrosion.

2. Twenty-inch (20") and larger valves may be resilient seated gate valves, AWWA C509 or butterfly valves, AWWA G504, with complete epoxy coating to avoid corrosion of all iron parts, as approved by the City Engineer. All valves shall be counterclockwise opening. Valves shall be direct bury type.
3. Cast iron valve boxes are required on all gate valves
4. All valves shall be sized equal to the size of the main upon which it is located.
5. Valves shall be approved by the City and shall be listed on the Approved Products List.

B. Valves shall be set at maximum distances along the main as follows:

1. Four-inch (4") through and including twelve-inch (12") mains - one thousand five hundred feet (1,500').
2. Sixteen-inch (16") and larger mains - two thousand two hundred feet (2,200').
3. All main intersections shall have a valve installed in each direction.

C. Valves shall be located as follows:

1. All mains shall be valved within the street right-of-way. Valves shall not be placed within four feet (4') of ultimate pavement (section 5.06.A), except as specifically approved by the City Engineer.
2. Valves are normally located on the projection of intersecting street right-of-way lines or at the curb return adjoining a paved street across the main. Tapping sleeves and valves are excluded from this requirement.
3. All fire hydrants shall be isolated from the service main with a valve located on the fitting at the main line.
4. Intermediate valves not located on the projection of intersecting street right-of-way lines may be located at lot line projections or five feet (5') from fire hydrants.
5. Valves shall be placed at the end of all mains that are to be extended in the future, and extend main a minimum of twenty feet (20') past valve. Valve and piping shall be restrained utilizing mechanical joint fittings, restraints and pipe joint restraints. Thrust blocks are not allowed.

5.11 FITTINGS AND APPURTENANCES

A. Fittings shall be Ductile-Iron Compact Fittings Three-Inch (3") to Twelve-Inch (12"),

AWWA C153/A21.53.84, conforming to the minimum requirements of "Gray-Iron and Ductile-Iron Fittings, Twelve-Inch (12") through Forty-Eight-Inch (48"), for Water and Other Liquids", AWWA C153 (ANSI 21.10), current revision. Fittings shall be furnished with epoxy or cement mortar lined, AWWA C104 (ANSI A21.4).

- B. All fittings shall be identified and described on the construction plans.
- C. Water main fittings shall be mechanical restrained joints.
- D. At dead end lines or lines installed for future extension shall be installed with a mechanical joint cap with a 2" tap for the installation of a blow-off. The mechanical joint cap and line shall be restrained.
- E. Polyethylene tube encasement shall conform with the minimum requirements of "Polyethylene Encasement for Gray and Ductile Cast-Iron Piping for Water and Other Liquids", ANSI/AWWA C105, current revision. Soils within the project shall be tested in accordance with Appendix A of ANSI/AWWA C105 to adequately determine the requirements for encasement. Minimum thickness of polyethylene encasement tubing is to be 8 millimeters.
- F. Concrete thrust blocking or mechanical restraints shall be required on all bends, tees, plugs and combinations thereof. Refer to City of Richmond Standard Construction Details for specifications.
- G. The maximum allowable size of a tapping sleeve and valve on an existing pipe should be smaller to the pipe diameter of the main to be tapped.

5.12 DUCTILE IRON WATER PIPE

- A. All transitions from ductile iron pipe to approved water main materials shall be constructed using mechanical joint fittings or flange joints.
- B. All ductile iron pipe shall be constructed of materials as specified in Section 5.05.

5.13 TESTING OF INSTALLED PIPE

- A. A hydrostatic ex-filtration test shall be performed on all water lines in accordance with the requirements of TCEQ and AWWA C600-10 (ductile iron pipe) or C605-13 (PVC pipe) prior to being placed in service.
- B. New water lines shall be thoroughly disinfected in accordance with AWWA Standard C651 and TCEQ requirements and then flushed and sampled prior to being placed in service. Bacteriological testing is to be done right after installation. The Department of Public Works will conduct initial Bacteriological testing; any retesting will be at the expense of the contractor.
- C. Copies of all test results shall be given to the City and any Municipal Utility District with jurisdiction.

5.14 EXISTING FACILITY CROSSINGS

- A. Installation of a water main across a proposed or existing highway, county road, public street, railroad, pipeline, or drainage way shall conform to the requirements of Section 5.16.

5.15 WATER SERVICES

- A. Water Service in Type A Development (Developer to provide unless otherwise noted on Plans)

- 1. Water service from the main to the meter curb stop shall be installed using materials from the Approved Products List.
- 2. Water service lines shall be placed at a minimum depth of twenty-four inches (24") below final paving elevation.
- 3. Meter boxes shall be located just within the public right-of-way along the projection of a lot line or in an easement. Location of meters on open ditch streets shall be specifically approved by the City Engineer.
- 4. All water service fittings and appurtenances for all projects shall be approved by the City and shall be listed on the Approved Products List.
- 5. Public system maintenance shall end at the water meter. The water meter box or vault shall be constructed to meet the City's requirements and will be maintained by the public entity.

- B. Water Service in Type B Developments

- 1. Backflow prevention (i.e. detector check valves) shall be required on fire lines.
- 2. Meters may be located in the water main easement provided the water main easement is located such that the accessibility and protection of the meter is as specified immediately above.
- 3. Service meters that are four inches (4") and larger and detector check valves shall be set in separate exclusive water meter easements with minimum dimensions of ten feet by twenty feet (10' X 20') and shall be located in easily accessible areas, adjoining a public right-of-way or water line easement, but protected from traffic behind curbed sections. Refer to the Construction Standards for details.
- 4. The location of the service line tee, valve, valve box and temporary plug shall be designated on the construction plans in the appropriate location to serve the "future meter".
- 5. All apartments or town homes proposed in a private street development shall have one or two master meters sized adequately to serve the entire development and equipped with a Reduced Pressure Zone Assembly. The reduced pressure zone assembly shall be equal to the meter size or as required by the design. The

reduced pressure zone assembly shall be installed in an enclosure. Exceptions to this policy may be specifically approved by the City Engineer based on an unusual situation. Meters shall be installed in compliance with the City of Richmond Standard Construction Details.

6. Location of water distribution appliances necessary for fire protection (i.e. vault, "PIE", post indicator valves, "FDC" fire department connections) shall be determined by the Fire Marshall.

5.16 ADDITIONAL STANDARDS

- A. Construction Features - In conjunction with the design, the engineer shall determine the extent of, and fully detail on the plans, all special construction features required to complete the project in a safe, convenient, and economic manner.
- B. Bore and Jack - Bore and jack sections shall be specifically approved by the City Engineer and clearly shown on plans by location and footage Refer to the City of Richmond Standard Details. The following criteria are generally used as a basis for setting bore and jack sections.
 1. Public Streets - All existing public streets are to be bored and jacked regardless of surface. Bore and jack length shall be computed as roadway width at proposed bore plus five feet (5') to either side.
 2. Driveways - Whenever it is cost effective, concrete driveways in good condition shall be bored and jacked. Bore and jack length shall be computed as driveway width at bore plus three foot (3') to either side. Where driveways cross culvert pipe sections along open ditch streets and the proposed water main is in close proximity and parallel to the culvert pipe, the length of bore shall be the same as the length of culvert pipe.
 3. Sidewalks - When the water line crosses under a sidewalk four feet (4') or more in width and in good condition, the sidewalk shall either be bored and jacked or the sidewalk shall be removed and replaced to the City of Richmond criteria, whichever is cost effective. Bore and jack length shall be at least the width of the sidewalk. The proposed type of construction shall be noted on the plans.
 4. Trees - When saving trees and shrubs in a previously developed area is a consideration, all trees six inches (6") and larger in diameter within ten feet (10') of the centerline of the water main must be noted on the plans. The water main shall be bored and jacked within the drip line of any tree larger than six inches (6") in diameter.
 5. Bore Pits - Bore pits shall be at least three feet (3') from back of curb. Bore pits in highway, county road, or railroad right-of-way shall conform to these requirements and to the requirements of the crossing permit and/or use agreement. All bore pits shall be shored in accordance with OSHA requirements. Bore pits and/or receiving pits to be located in street or driveway paving, shall be shown on plans.
 6. Open Cuts – Open cuts require specific approval of the City Engineer. Where

open cuts are allowed in street paving, plans shall call for steel plate covers to be installed and maintained over the cut during periods when contractor is not actively engaged in work at the site. Streets that are open cut shall be "saw cut" prior to pavement removal. Saw cut shall be full depth.

- C. All existing developed areas shall be restored to original condition after construction.
- D. Proper barricading and signage, conforming to the Texas Manual of Uniform Traffic Control Devices' latest edition, shall be required on all projects. Adequate signage for vehicular and pedestrian traffic shall be installed. A traffic control plan shall be submitted to the City of Richmond and approved by the City Engineer for all streets open to travel by the public.

END OF CHAPTER



City of Richmond

Design Manual

Chapter 6

SANITARY SEWER SYSTEMS

CHAPTER 6

SANITARY SEWER SYSTEMS (*REVISED JANUARY 2019*)

6.01 GENERAL

- A. This chapter includes the minimum design requirements for sanitary sewer collection and treatment systems within the city limits and the extra-territorial jurisdiction of the City of Richmond.
- B. The Richmond Public Works Department shall approve sanitary sewer collection and treatment system plans for all public improvements within the Richmond city limits or extraterritorial jurisdiction. Construction shall conform to the City of Richmond Construction Details.
- C. Construction plans for private improvements, within public right-of-ways and public easements that connect to or affect the public infrastructure shall be approved by the City of Richmond subject to the requirements of this manual and are subject to review and approval using the process defined in this manual.
- D. Construction and sizing of all sanitary sewer mains and appurtenances shall meet or exceed the requirements of the Texas Commission on Environmental Quality and the Texas Department of Health.
- E. The public sanitary sewer system shall be defined as all sewers, including stacks and service leads that are located in public easements or street rights-of-way, and that are installed in accordance with these Standards. The public sanitary sewer system shall not extend beyond the service connection. All public construction shall conform to the requirements of this manual. All private construction beyond the service connection shall conform to the requirements of the City of Richmond Plumbing Code.
- F. All proposed sanitary sewer systems and interconnects between separate systems and/or utility districts, shall be approved by Richmond Public Works Department.
- G. Sanitary sewer service shall be extended to all building sites prior to development. Septic systems are not allowed, except as specifically approved by the Department of Public Works.

6.02 DESIGN REQUIREMENTS

- A. Sanitary sewer systems shall be designed to handle the necessary flow based upon complete development. The necessary flow shall include applicable residential and non-residential average daily flows and shall include a minimum peak design flow of 4 times the average daily flows. Sanitary sewer systems within the City of Richmond's jurisdiction shall allow for orderly expansion of the system and shall conform to the Wastewater Master Plan and the Utility Policy for the City of Richmond.
- B. The average day flow for the design of sanitary sewers shall be based on 350 gallons per day per single-family connection for residential areas. Commercial, industrial, and office areas shall be designed for an average day flow that can be anticipated from contributing area.

- C. One copy of the system hydraulic calculations, sealed by a Texas Registered Professional Engineer, shall be provided electronically (PDF format) with all sanitary sewer system plans. These calculations shall show how the sanitary flow rates were computed; design assumptions and that Texas Commission on Environmental Quality requirements are met. If the proposed sanitary sewer system is connecting to an existing system, verification of the availability of capacity in the existing system, after inclusion of the new system, shall be provided by the design engineer and approved by the City and any applicable Municipal Utility District.
- D. All gravity sewers will be designed to accommodate the peak flow from the contributing service area. The peak flow will be computed using the appropriate peaking factor, F, multiplied by the average day flow for the contributing area. For nonresidential areas, the peak flow should include consideration of flow characteristics from the anticipated development. The minimum allowable values for the design peak factor are:
 - 1. In all cases, the design peaking factor, F, shall meet or exceed the values as follows:
 - a. An equivalent population less than 5,000 persons:
F = 4
 - b. An equivalent population greater than or equal to 5,000 persons:
F = (14 / (3.316 + P^{0.5})) + 1.5
P = equivalent population in thousands
 - 2. Sewers larger than eighteen-inch (18") may be sized using a peaking factor of less than four (4) with approval of the City Engineer.
- E. Additional consideration of peak flow shall be given for design of pumping stations. The impact of pumping stations on the upstream and downstream sanitary sewer system shall be evaluated. The peak flow for design of a pumping station shall be based on the actual flow into the station. A reduced peak flow, based on the peaking factor presented above, may be used for design of larger pumping stations provided a detailed hydraulic analysis is performed on the sanitary sewer system. Specific approval by the Department of Public Works shall be required prior to use of a reduced peak flow for the design of a pumping station and related sanitary sewer system.
- F. The minimum size allowable public sewer shall be six-inch (6"). Public sanitary sewers are not allowed in back lot/rear yard easements.
- G. The minimum size residential sanitary sewer service lead shall be four-inch (4") for single resident and six-inch (6") for two (2) residential services.
- H. Commercial sewer service leads shall be six-inch (6") pipe or larger and shall not serve more than one (1) commercial connection.
- I. All elevations shall be shown to the nearest one-hundredth of a foot (0.01').
- J. All mains to be installed under an existing roadway should be installed by bore unless otherwise approved by the City Engineer.

6.03 SYSTEM LAYOUT AND PLACEMENT

- A. All sanitary sewer systems shall be designed in conformance with the requirements of the Texas Commission on Environmental Quality and other applicable standards.

- B. The minimum depth of a sewer along a curb and gutter street shall be four feet (4') below finished grade or top of curb to the top of pipe whichever is lower. Sanitary sewers laid along open ditch streets shall have a minimum cover of six feet (6') from the average ground line at the adjacent street right-of-way or 3 feet below the flowline of the open ditch to the top of the pipe whichever is lower.
- C. The maximum allowed depth for sanitary sewer collection lines is eighteen feet (18') from finish grade to invert of pipe. Sanitary sewers greater than ten feet (10') in depth to invert of pipe require exclusive easements as stated in Section 6.06. Credit for usable right-of-way will be allowed as outlined in Section 6.06. Building lines shall not encroach upon sanitary sewer or other utility easements.
- D. Sanitary sewers shall be laid in a straight alignment, manhole-to-manhole. No curvilinear bends are allowed.
- E. Sanitary sewer hydraulic requirements include:
 - 1. Design velocity in a gravity sewer flowing full shall be a minimum of two point zero feet (2.0') per second and a maximum of four point five feet (4.5') per second. In both cases, the Manning Formula has been used with an n coefficient of 0.013. The use of different pipe materials will not alter the use of n=0.013 for the purposes of design.
 - 2. For sewers larger than twenty-seven inches (27") in diameter, the Professional Engineer of record shall determine the appropriate grade utilizing the Manning Formula, n=0.013 and a minimum full pipe velocity of 3.0 fps. Minimum acceptable slopes in sewers smaller than twenty-seven inches (27") in diameter shall be:

Minimum and Maximum Pipe Slopes

Size of Pipe (Inches)	Minimum Slope (Percent)	Maximum Slope (Percent)
6	0.50	12.35
8	0.33	8.40
10	0.25	6.23
12	0.20	4.88
15	0.15	3.62
18	0.11	2.83
21	0.09	2.30
24	0.08	1.93
27	0.06	1.65

- F. Unequal size sewers shall be designed so that the inverts of the pipes are matched at manholes. The upstream sewer may be designed so that the flow line of the upstream is higher than the flow line of the downstream sewer. When the flow line of the upstream sewer is raised more than twenty-four inches (24") above the flow line of the downstream sewer, a drop manhole connection is required, except as specifically approved by the Department of Public Works. All drops shall be exterior.
- G. Sanitary sewer service leads shall be laid a at minimum sixty-five hundredths of a percent (0.65%) slope.

H. Manhole requirements include:

1. Manholes shall be placed at points of changes in alignment, grade, or size of sewers, at all four (4) way connections and three (3) way connections, and at the end of all sewers. Clean-outs will not be permitted on public lines.
2. Manholes shall be spaced at a maximum distance of four hundred feet (400') apart.
3. Manholes shall have a traffic bearing frame and cover. Manholes shall have a design strength of 4500 psi and in compliance with ASTM C478 reinforcement.
4. Manholes should be located to eliminate the inflow of storm water into the sanitary sewer. The top of manhole rim elevation shall be shown on the plans for all sanitary manholes. Manholes shall not be located within street pavement without prior approval of City Engineer. Manholes shall have inflow protection inserts, minimum thickness of one-eighth inch (1/8"), made of HDPE meeting ASTM D 1248 Class A, Category 5, Type 111. Insert shall include a lift strap and vent hole with vent disk. Manholes may be sealed with gaskets and bolts when specifically approved by the Department of Public Works. Where gasketed manhole covers are required for more than three (3) manholes in sequence, an alternate means of venting shall be provided at less than one thousand five hundred feet (1500') intervals.
5. Manholes shall be constructed in accordance with the City of Richmond Construction Details. The diameter of a manhole constructed over the center of a sewer shall vary with the size of the sewer. For eight-inch (8") through twelve-inch (12"), the manhole shall be four-foot (4') minimum diameter, for fifteen-inch (15"), -through twenty-seven-inch (27") shall be five-foot (5') minimum diameter; thirty-inch (30") and thirty-six-inch (36") shall be six-foot (6') minimum diameter. Manholes deeper than twelve feet (12') shall be a minimum of five-foot (5') diameter or six-foot (6') diameter pending on pipe size. If a drop structure is required the manhole shall be a minimum of five-foot (5') in diameter.
6. A drop manhole is required for pipes that have a change in elevation greater than twenty-four inches (24"). The manhole will be a minimum five foot (5') diameter. The use of an exterior drop is required.
7. Steps in manholes will not be permitted.
8. Manhole covers shall be thirty-two inches (32") in diameter or larger, cast iron, traffic bearing type ring and cover with the words "sanitary sewer" and the City of Richmond logo cast into the cover. All manhole covers shall be made impermeable to surface drainage by providing a solid cover per City of Richmond standard detail. Wherever manhole is placed in a low-lying area, an additional impermeable lining shall be provided underneath the cover to prevent inflow.
9. All manhole adjustments shall be made with three inch (3") precast concrete rings. A maximum of five (5) adjustment rings are permitted.
10. Manhole cones shall be eccentric cast.
11. All new manholes shall have an interior surface coated with an approved epoxy coating a minimum of 80 mils thick. If the project requires a rehabilitation of an existing manhole

the epoxy coating thickness shall be 125 mils thick. Bituminous coatings are not allowed. Approved coatings are listed in the Approved Products List. Coatings shall be tested with a Holiday tester. Testing shall be in accordance with latest edition of NACE “Standard Recommended Practice Discontinuity Testing of Protective Coatings”. All holidays shall be marked and repaired and retested. All joints shall be grouted smooth prior to installation of the interior coating. Should the manhole be pre-coated at the place of manufacturing the joint shall be grouted smooth and the grouted area shall be coated in accordance with this section.

12. Fiberglass manholes are not allowed as part of public sanitary sewer systems. All manholes within public right-of-ways and public easements shall be pre-cast or cast-in-place manholes.
 13. Where unequal size pipes enter a manhole, inverts of pipes are required to be at the same elevation, unless due to an elevation drop connection.
- I. Stacks shall be constructed for connections to sewers that are more than eight feet (8') below finished grade. Stacks shall be provided during the initial construction of the sewer. All stack connections shall be in-line fittings. All stacks shall be installed within 3% of plumb relative to vertical plane and will be capped and terminated. A cleanout shall be installed and terminated 6" below grade with a threaded cap and a box. The service connections at the wye shall be terminated four-feet (4') below ground.
- J. Service connection requirements include:
1. Sewer service leads shall not exceed one hundred twenty-five feet (125') in length, unless approved by the City Engineer. Near side double sewer service leads shall not exceed twenty feet (20') in length and may extend across a public right-of-way or easement. All leads shall not be deeper than eight feet (8').
 2. For Single-Family Residential Lots
 - a. Far side service connections shall be installed at the time of construction of the sewer. Double sewer service leads shall be located within a public right-of-way or easement.
 - b. Service connections shall be constructed of materials as described in Section 6.05.
 - c. Service connections should be installed at a manhole, when possible.
 3. For Multi-Family Residential, Commercial, and Office Development.
 - a. Service connections shall be made at a manhole. Long service connections should be installed at the time of construction of the sewer.
 - b. Service connections shall be constructed of materials as described in Section 6.05.
- K. General requirements for service connections at manholes include:
1. Service connections shall be made at manholes whenever possible. When a service connection stub-out is not provided, an opening shall be cored out of the manhole at the

required elevation. The service connection shall be extended into the manhole and the opening secured with "Linkseal", grouted and the manhole coating shall be repaired per the coating manufacturer's recommendations.

2. A service connection at a concrete manhole shall have a rubber boot that is cast into the manhole or the service location shall be cored. If cored refer to 6.03.K.1 for repair requirements. The rubber boot shall be secured and then grouted. The manhole interior coating shall be repaired per the manufacturer's recommendations. When a hole for a service connection in an existing brick manhole exceeds eighteen inches (18"), the manhole shall be rebuilt above the disturbed area.
 3. Service connections entering a manhole thirty-six inches (36") or more above the flow line of the manhole shall include an internal drop pipe with fittings. The drop shall consist of a "Reliner" internal drop bowl system, or approved equal, installed adjoining and anchored to the wall of the manhole, with all stainless steel hardware and fasteners. The cored opening for the pipe shall be secured with "Linkseal", grouted and the manhole coating shall be repaired per the coating manufacturer's recommendations
 4. Provide adequate markings on site and accurate as-built locations, so that the service connections stub-out can be recovered at the time that the connection to the service is made.
- L. Each sanitary sewer service lead stub, wye and stack shall be marked in accordance with the City of Richmond standard detail drawings at the time of construction, beginning at the flow-line of the stub and extending two feet above finished grade.
- M. All connections to the public sewer system shall be approved by the Department of Public Works prior to construction. A representative of the utility system operator shall inspect actual connections to the public sewer system.
- N. Service connections that are installed after initial construction of a sewer shall be constructed using a P.V.C. saddle with gasket and stainless steel straps as approved by the Department of Public Works.
- O. All stationing shall be based on centerline of street right-of-way stations. In utility easements where both sanitary sewer and storm sewer piping are constructed and laid in parallel trenches, stationing shall be based on centerline of storm sewer piping.

6.04 SANITARY SEWER BEDDING AND BACKFILL REQUIREMENTS

- A. All bedding and backfill shall be in accordance with the City of Richmond Standard Construction Details. All backfill within public right-of-ways and public easements shall be compacted to a minimum of ninety-five percent (95%) of Standard Proctor Density (ASTM D2922-78 and ASTM D3017-78), without additional moisture control, cured and tested in accordance with ASTM C31.
- B. All sanitary sewer lines located underneath and within three feet (3') of any paving shall be bedded in cement stabilized sand in accordance with the Standard Construction Details. The cement stabilized sand shall be in accordance with the following requirements.

1. The cement shall be Portland Cement, Type I, ASTM C150.
 2. The sand shall be clean, durable sand, with less than 0.5 percent clay lumps, ASTM C142; with less than 0.5 percent lightweight pieces, ASTM C123; with organic impurities, ASTM C40, not showing a color darker than standard color and a plasticity index of less than six (6) when tested in accordance with ASTM D423 and ASTM D424.
 3. Compact to ninety-five percent (95%) Standard Proctor Density (ASTM D2922-78 and ASTM D3017-78) in maximum loose lifts of eight inches (8") thick. Actual testing shall be required as deemed necessary by the City of Richmond.
 4. The cement-sand mixture shall consist of at least 2.0 sacks of cement per ton of sand. The cement-sand mixture shall have a minimum unconfined compressive strength of one hundred pounds per square inch (100 psi) in forty-eight (48) hours, when compacted to a minimum of ninety-five percent (95%) of Standard Proctor Density (ASTM D2922-78 and ASTM D3017-78), without additional moisture control, cured and tested in accordance with ASTM C31.
- C. Sanitary sewers outside of paving shall be bedded in accordance with the Standard Construction Details and the cement stabilized sand utilized shall meet the same requirements as listed in Section 5.09 B.
- D. Sanitary sewer bedding will be cement stabilized sand. Bedding shall be compacted to ninety-five percent (95%) Standard Proctor Density twelve inches (12") over pipe prior to backfilling the trench. In water bearing sand, washed shell or other approved granular material will be required with geo-textile fabric wrap as shown in the Standard Construction Details. When water bearing sands are encountered, the City of Richmond shall be notified immediately.

6.05 SANITARY SEWER SYSTEM MATERIALS

- A. All materials used in the construction of sanitary sewer systems shall be in conformance with the City of Richmond Approved Products List and the requirements of the Texas Commission on Environmental Quality. Sewers shall be designed to meet or exceed the pipe manufacturer's recommendations for depth
- B. Solvent welded sanitary sewer joints are not an acceptable joining method for PVC piping materials. Use of rubber gasketed bell and spigot sanitary sewer joints shall be mandatory.
- C. Sanitary sewers twelve inches (12") or less in diameter and installed at depths of twelve feet (12') or less to invert shall be constructed conforming to ASTM specification D 3034 SDR-26 (160psi) and shall meet ASTM specifications D 3212 for pipe joined with rubber gaskets conforming to ASTM F477. Bell (female) ends of pipe shall be installed on upstream side with spigot (male) ends oriented downstream. Note: See approved Products List
- D. All sanitary sewers greater than eighteen inches (18") in diameter and less than twenty-seven inches (27") in diameter and installed at depths of eighteen feet (18') or less to invert shall be constructed conforming to ASTM specification F 679 SDR-26 (115psi) and shall meet ASTM specifications D 3212 for pipe joined with rubber gaskets conforming to ASTM F477. Bell (female) ends of pipe shall be installed on upstream side with spigot (male) ends oriented downstream. Note: See approved Products List

- E. Sanitary sewers exceeding 27" in diameter shall be constructed of PVC pipe approved by the City Engineer. Bell (female) ends of pipe shall be installed on upstream side with spigot (male) ends oriented downstream.
- F. All force mains twelve inches (12") or less in diameter shall be constructed of PVC and shall be AWWA specification C 900, Class 150, DR 18, color shall be green and shall meet ASTM specifications D 3139 for pipe joined with rubber gaskets conforming to ASTM F 477 or Ductile Iron Pipe shall conform to the requirements of "Ductile-Iron Pipe, Centrifugally Cast in Metal Molds for Sand-Lined Molds, for Water and Other Liquids", AWWA C151, (ANSI A21.51), current revision. Pipe shall be lined with Protecto 401 ceramic epoxy lining or approved equal. Pipe thickness shall be the minimum specified in C151. Bell (female) ends of pipe shall be installed on upstream side with spigot (male) ends oriented downstream. All ductile iron fittings shall be mechanical joint and restrained with Ebba "Meg-a-lugs" or approved equal. The fittings shall be lined with Protecto 401 ceramic epoxy lining or approved equal.
- G. All force mains greater than twelve inches (12") shall be AWWA specification C 905, Class 235, DR 18, color shall be green and shall meet ASTM specifications D 3139 for pipe joined with rubber gaskets conforming to ASTM F 477 or Ductile Iron Pipe shall conform to the requirements of "Ductile-Iron Pipe, Centrifugally Cast in Metal Molds for Sand-Lined Molds, for Water and Other Liquids", AWWA C151, (ANSI A21.51), current revision. Pipe shall be lined with Protecto 401 ceramic epoxy lining or approved equal. Pipe thickness shall be the minimum specified in C151. Bell (female) ends of pipe shall be installed on upstream side with spigot (male) ends oriented downstream. All ductile iron fittings shall be Ductile-Iron Compact Fittings AWWA C153/A21.53.84 mechanical joint and restrained with Ebba "Meg-a-lugs" or approved equal. The fittings shall be lined with Protecto 401 ceramic epoxy lining or approved equal. A two-inch (2") wide green marker tape with the words "Sanitary Sewer Forcemain" shall be installed twelve inches (12") above the top of pipe during installation.
- H. Bedding and backfill shall conform to Section 6.04 and to the City of Richmond Construction Details.

6.06 LOCATION OF SANITARY SEWERS AND EASEMENT REQUIREMENTS

- A. Sanitary sewers shall be designed and located to conform to regulations of the Texas Commission on Environmental Quality. Sanitary sewer easements shall be dedicated for the specific intended use. Easements for a specific facility shall be exclusive and shall not overlap other easements, except to cross the easements.
- B. Sanitary sewers with a maximum depth of ten feet (10'), measured from finished grade, shall be placed within the right-of-way at least four feet (4') from the back of curb, except as provided herein. Sanitary sewers shall be placed along a uniform alignment within the right-of-way.
- C. All sewers that are deeper than ten feet (10') shall be centered in an exclusive easement parallel to and adjoining the right-of-way. Where required, additional easement shall be provided adjoining the right-of-way to provide required clearances. An exclusive sanitary sewer easement adjoining a public right-of-way may be five feet (5') wide provided the sewer is at least five feet (5') from the edge of the easement and the sewer is no deeper than ten feet (10'). Sewers at greater depth than ten feet (10') shall be centered within an exclusive easement parallel and adjoining the right-of-way, as required by Section 6.06 D.

- D. The width of all exclusive sanitary sewer easements shall be equal to the depth of the sewer from finished grade plus two (2) pipe diameters. If the exclusive easement is located adjacent to public right-of-way, credit for usable right-of-way may be calculated as follows. The initial estimate for the exclusive easement width shall be equal to the pipe depth, plus two pipe diameters, rounded up to the nearest five foot increment. The width of usable right-of-way may be then subtracted from the initial estimate for the required minimum width of the exclusive easement adjacent to the right-of-way. At no time shall the exclusive easement calculated in this manner fall below five feet (5') in width. The sewer shall be located in the center of the easement unless otherwise approved by the City Engineer. Usable ROW is defined as 2 ft behind curb to ROW line.
- E. The minimum width of a sanitary easement not located adjacent to a public ROW shall be twenty feet (20') centered along a lot line, and twenty feet (20') wide for easements located within a single lot.
- F. Exclusive easements or reserve for force mains of all sizes shall have a minimum width of twenty feet (20) for a single force main where the force main is not located adjacent to a public right-of-way. Where the force main is located in an easement adjacent to public rights-of-way, the force main may be located at the center of a ten-foot (10') easement. Where the force main is located less than five feet (5') from the right-of-way line within the public right-of-way, the minimum easement width shall be 10 feet (10') adjacent to the right-of-way.
- G. Where sanitary sewers or force mains are installed in easements separated from public rights-of-way by other private or utility company easements, the sanitary sewer easement should be extended along or across the private utility company easement to provide access for maintenance of the sewer or force main.

6.07 CLEARANCE OF WATER LINES FROM SANITARY SEWER LINES

- A. Sanitary sewers shall be designed and located to conform to regulations of the Texas Commission on Environmental Quality. For water mains crossing an existing or proposed sanitary sewer or force main, the following clearances shall be provided for protection from contamination. The minimum clearances will be approved only when justified and field conditions so dictate. The latest edition of "Rules and Regulations for Public Water Systems", of the Texas Commission on Environmental Quality, shall be followed for minimum criteria and instructions for water line crossings.

6.08 LIFT STATIONS AND FORCE MAINS

- A. Lift stations shall be designed in conformance with the TCEQ Design Criteria for Sewerage Systems" (latest edition). Lift stations should be considered only when a gravity system cannot be achieved. All lift stations shall be specifically approved by the City Engineer. The Design Engineer shall provide design requirements and pertinent data with construction plans for review. A preliminary design meeting with the Department of Public Works is recommended. Lift stations shall be designed as follows.
 - 1. The lift station site shall be conveyed in fee to a utility district, the City of Richmond, or other acceptable public entity. The site may be part of a larger site that includes a public wastewater treatment facility or other facility. The site shall have a minimum size of 50

feet by 50 feet. Site access shall be provided by a 20-foot (20') wide public right-of-way with an approved, all-weather access road a minimum of 16 feet (16') in width. Wet well structures shall be a minimum of 12 feet from outside walls of structure to the site boundary fencing. Fencing shall be in conformance with the City of Richmond Zoning Ordinance.

- B. Use drainage swales, sidewalls and driveways, culverts, storm sewers, or a combination thereof for internal site drainage. Site drainage may sheet flow to a public right-of-way. Storm sewer systems, if provided shall be sized in accordance with applicable design guidelines.
- C. The top of the wet well and all electrical controls shall be located minimum twelve inches (12") above the 100-year floodplain, and the design engineer shall take into consideration wave action, which may exceed this elevation. Entry to the site must be accessible during a 25-year flood.
 - 1. All gravity sanitary sewers discharging to the wet well shall be located where the invert elevation is at or above the liquid level of the highest pump's "ON" setting to achieve the firm pumping capacity. Plug valves and check valves shall not be located in the wet well, but may be located in a valve vault or on a concrete slab. Piping shall be spaced to maintain the pump manufacturer's minimum clearances between pumps.
 - 2. Size the diameter of the wet well, hatches, and hatch spacing to accommodate the selected pumping equipment. Consideration should be given to the dimensions of the ultimate pump in a multi-phased lift station to ensure adequate clearances. Provide a minimum of eighteen inches (18") of clearance from the inside wet well wall to all flanges to enable removal of all bolts. Pre-cast concrete wet wells may be used in any diameter provided calculations demonstrate that wet well thickness and material weight will resist imposed up- lift pressure. Provide hatch safety nets with aluminum sliding rails or Flygt Safe-hatch access cover.
 - 3. The wet well volume shall be based on the minimum cycle time of the largest pump planned for the lift station plus additional depth to prevent motor overheating and vortexing. Wet well working volume should be sized to allow for the recommended pump cycle for each pump. The cycle time shall not be less than those listed below:

CYCLE TIME

Motor Size (Horsepower)	Cycle Time (Minutes)
< 50	6
50-100	10
>100	15

- 4. The "OFF" elevation of the submersible pumps shall be deep enough to prevent vortexing and motor overheating. The design engineer shall verify with all pump manufacturers on the List of Acceptable Manufacturers that each pump is capable of operating continuously at the "OFF" elevation shown on the plans.
- 5. The wet well floors shall have a minimum of 10 percent slope to the pump intakes and have a smooth finish. There shall be no wet well projections, which will allow deposition of solids under normal operating conditions. The inlet structure shall be designed to minimize turbulence.

6. The wet well shall have a vent sized such that the maximum velocity of air through the vent is 600 feet per minute at the firm pumping capacity. Vents shall have a stainless steel insect screen that is easily replaceable and will prevent the entrance of rainwater. Vent pipes shall be corrosion-resistant.
 7. All discharge piping will be above ground unless approved by City Engineer.
 8. Access shall be provided to underground valve vaults approved by City Engineer. Stairways shall have corrosion-resistant, non-slip steps and conform to OSHA regulations with respect to rise and run. Where ladders are utilized in lieu of stairways, ladders shall conform to OSHA requirements.
 9. Floor drains from valve vaults to wet wells shall be designed to prevent gas and raw sewer water from entering the valve vault. Such designs shall include "P" traps and floating ball type backwater valves.
 10. All walls shall be a minimum of 18 inches from the outermost edge of all flanges to enable removal of all bolts. Pipes shall have a minimum spacing greater than that required by the pump manufacturer for minimum pump spacing. Swing check valves shall be positioned such that the shafts may be removed without removing the valve body.
- D. Design shall follow the latest version of ACI 350 with the exception that the minimum concrete cover over steel reinforcing shall be at least four inches (4") where in contact with raw sanitary sewer. Wet wells shall be designed to resist the effects of buoyancy assuming full saturation of the surrounding soils to the finished grade or the 100-year floodplain, whichever is greater. Surface friction shall not be included in the design unless a friction factor is provided in a geotechnical report signed and sealed by a licensed professional engineer. A safety factor of 1.1 shall be used for buoyancy resistance. Wet well walls shall be designed to withstand lateral earth pressures and static water levels at finished grade as outlined in ACI 350. At a minimum, 4,000 psi concrete shall be used. Class III or IV RCP may be used in lieu of cast in place concrete if structural calculations are provided showing that sufficient strength exists to resist construction and final loadings. Top slabs shall be designed for a uniform loading of 100 pounds per square foot and a point load equal to the weight of the largest pump planned for the lift station at any location.
1. Hatches shall be constructed entirely of aluminum or stainless steel and designed for a minimum of 150-pound-per-square-foot load. The underside of the hatch shall have the following stenciled in red paint: "Warning! Confined Space Entry." Where individual hatches are incorporated into the top slab, the separation distance from inside face to inside face shall be a minimum of 12 inches.
 2. Where riser pipes pass through the top slab, offsets or two 45-degree bends shall be used to provide clearance between the outside diameter of the pipe and the inside face of the hatches. The amount of clearance will be determined by the diameter of the slab reinforcing and the maximum aggregate diameter.
 3. Use of vault-type OR above-ground valves and piping is permitted. Valves shall be mounted in a concrete vault, or on an above-ground concrete foundation. Isolation and check valves shall not be located in the wet well.

4. Pumps shall be of a non-clog design, capable of passing a 3-inch diameter or greater incompressible sphere, and shall have suction and discharge openings a minimum of 4 inches in diameter. Pump seals shall be silicon carbide or tungsten carbide. A preflush is required on submersible pumps.
 5. Pumps shall be sized to operate at optimum efficiency. Minimum acceptable efficiency at the operating point shall be sixty percent (60%), unless specifically approved by the City Engineer. Leak detection sensors shall be provided in the motor housing of submersible pumps. Pumps shall be securely supported, per manufacturer recommendations, so as to prevent movement or vibration during operation. Rail-type pump support systems shall be provided for submersible pump installations. That allows pump removal and installation without requiring dewatering of or entry into the wet well. Rails, lifting chains, and hardware shall be constructed of Series 300 stainless steel.
 6. Electric motors shall be sized so as to operate at maximum design load without use of the service factor. Electric motors shall be 120-volt single-phase, 240-volt or 480-volt 3-phase. Motor service factor shall be a minimum of 1.15. Thermal protection shall be provided in the motor housing. Electric motors (excluding submersible units) shall be equipped with space heaters.
- E. The following electrical power sources shall be considered for serving lift stations:
1. For stations where total pump motor sizes do not exceed 30 hp, and where any individual pump motor size does not exceed 20 hp, 120/240-volt, three-phase service is recommended.
 2. For stations where individual pump motor sizes do not exceed 5 hp and motor ratings are available as single-phase, and where three-phase service is not available, 120/240 volt, single-phase service may be used.
 3. For stations requiring pump motors that are available in only three-phase ratings and where three phase electrical service is not available (or not economically feasible), 120/240-volt, single-phase service with a three-phase inverter unit is acceptable as a last resort but is not recommended. Inverters are available for up to 100-hp motor sizes.
 4. For stations where total pump motor sizes exceed 30 hp and where individual motor sizes exceed 20 hp, 480/277-volt, three-phase service is recommended.
 5. Where owner has an existing portable generator with only 480/277-volt, three-phase output, it may be more advantageous to utilize 480-volt, three- phase power for the smaller stations.
 6. Emergency power connections shall require a manual transfer switch and generator connector.
- F. Controls and equipment shall be selected from the City of Richmond Approved Products List. The pump controller shall be a solid state, programmable pump controller with pump alternator, submersible level transducer, back-up floats, alarm contacts, and power supply. The use of a Variable Frequency Drive is acceptable. Lightning and surge protection shall be installed on the Main Power Bus, single- or three-phase, as applicable.

G. The following controls and indicators shall be provided.

1. Pump HOA Selector Switch (for each pump)
2. Alarm Reset Switch
3. Seal-Fail and Over-Temp Reset Switch (for each pump protection module supplied by pump manufacturer)
4. Phase-Fail Light
5. Pump Run Light (for each pump)
6. Control Power Light On
7. Pump Seal-Fail Light (for each pump protection module - supplied by pump manufacturer)

8. Pump Over-Temp Light (for each pump protection module - supplied by pump manufacturer)
9. High Level Alarm Indicator
10. Alarm Rotating Beacon Light (on side of panel)
11. Pump Run Elapse Time Meter (for each pump)

H. The following motor protection devices shall be provided.

1. Motor Circuit Protectors (MCP's) or circuit breakers
2. Motor Overload Current Trip Devices or C.T.'s with Relays (for each motor)
3. Motor Over-Temp and Seal Fail Relays (for each motor - furnished by pump motor manufacturers)
4. Phase Fail Relay

I. Level Controls

1. Primary: Solid state submersible pressure transducer, rated for wastewater application
2. Back-up: PVC ball type float with mercury switch - high and low level

J. Operation: As level rises, the submersible level transducer detects the pressure change and sends a 4-20 MA signal that is proportional to wet well level to the pump controller.

1. Each pump is brought on as level rises, and when wet well level falls back to a preset level, all pumps stop.
2. Pump alternator in the controller alternates lead/lag pump selection at end of each pumping cycle.
3. If pumps fail to draw down wet well, high-level alarm signal is initiated at the pump controller and controller automatically switches to standby floats for activation of pump controls.
4. In the event of fail signal from transducer, controller automatically switches to floats.

K. Alarm Signals

1. Alarms activate local indicator lights and send signals to an approved autodialer.

L. Pump Cable Terminal Boxes

1. NEMA 4X stainless steel boxes mounted near pump access hatch for termination of pump power and control cables and for termination of transducer and float cables.

2. All hub-type conduit entries.
- M. Control Panel Enclosure
1. NEMA 4X stainless steel enclosure on factory stainless steel stands with inside swing door, back plate, quick release latches, and hooking clasp.
 2. All hub-type conduit entries.
- N. Emergency operations shall be considered. Provide fittings, valve, and a blind flange that will be readily accessible for emergency bypass pumping.
- O. Force mains shall be a minimum of three inches (3") in diameter, unless used in conjunction with grinder pumps. Pump stations with two pumps shall have force main velocities of a minimum of 3 fps with one pump in operation. For pump stations with three or more pumps, the force main velocity shall not be less than 2 fps with the smallest pump only in operation. Force main velocities shall not exceed 6 fps without the engineer performing an analysis for possible high and low negative surge pressures in the event of sudden pump failure.
- P. Isolation valves shall be provided on the discharge side of pumps for submersible pumps and suction and discharge side of pumps for dry pit lift stations, positioned such that the pump and/or check valve can be isolated for removal. Plug valves shall be used. Check valves shall be swing type with an external lever and shall be installed in a horizontal position. Use of butterfly valves, tilting disc check valves, or other valves utilizing a tilting disc in the pipe flow is not permitted.
- Q. Surge relief valves, air release, and/or combination air and vacuum valves shall be provided, as required.
- R. Lift station piping shall have flanged, grooved (Victaulic) or flexible connections to allow for removal of pipe and check valves without interruption of the lift station operation.
- S. Lift stations shall be designed to discharge the peak design flow at the system head required and to operate efficiently during any initial, interim, or ultimate design phase.
- T. Firm pumping capacity shall be provided, and is defined as total station, maximum pumping capacity, with the largest pumping unit out of service.
- U. Pump selection shall be based on the analysis of the system head and pump capacity curves for the determination of pumping capacities. System losses shall be calculated in accordance with the Hydraulic Institute standards. The selected C coefficient value for use in the calculation of friction head losses per the Hazen-Williams Formula shall be based on the selected pipe material for new and aged (20-year) conditions.
- V. Force main velocities shall be included on the system curve.
- W. Chemical feed odor control for force mains shall be provided at the lift station if travel time, cycle time or other conditions create the odor problems.
- X. Design considerations shall include corrosion control and protection of concrete and metallic surfaces located within the wet well/valve vault or within the immediate vicinity from the effect of hydrogen sulfide (H₂S) gas in the wastewater. The effects of H₂S gas should be minimized by reducing the production or release of H₂S gas from the wastewater discharging to or being

contained in the lift station. Design and control methods shall include:

1. Protecting the exposed concrete and steel surfaces with an epoxy lining. Refer to Approved Products List for list of materials. Exposed piping shall be protected with a 100% solids novolac epoxy or approved equal.
 2. The use of Series 300 stainless steel for equipment, piping, devices, etc., exposed to corrosive gases.
 3. Providing odor control equipment for wet well atmospheric vents.
 4. Design wet wells that lack interior corners, projections, or areas that can result in the accumulation of solids. Design wet well with automatic agitator to flush prior to starting. Design interior surfaces with smooth finishes that facilitate cleaning.
 5. Submersible pumps with a horsepower greater than 20 will require cooling jackets.
- Y. Corrosion protection shall be provided by coating interior concrete surface of the wet well, structural steel, piping and hangers, air systems, electrical, mechanical and other components subject to a corrosive environment. All metal components subject to a corrosive environment shall be stainless steel or aluminum unless otherwise approved by the Department of Public Works. Surfaces to be protected include:
1. Interior of wet well: The interior of the wet well shall be coated with an approved epoxy coating. Refer to Approved Products List for list of materials.
 2. Piping located within wet well: Exposed piping shall be protected with a 100% solids novolac epoxy or approved equal.
 3. Guide rails, lifting chains, hardware, and miscellaneous metal shapes located within wet well shall be constructed/manufactured of Series 300 stainless steel.
- Z. Lift station construction plans shall include drawings that provide the following information:
1. Site layout
 2. Plan and profile of pump station and associated site piping
 3. Profile view of pump operational and control levels and settings
 4. Hydraulic system curve
 5. Electrical wiring and control system schematics
 6. Structural details

6.09 TESTING OF INSTALLED PIPE AND MANHOLES

- A. An infiltration, ex-filtration test or low pressure air test shall be performed on gravity sewer lines in accordance with Texas Commission on Environmental Quality, ASTM C 924 (Standard Practice for Testing Concrete Pipe Sewer Lines by Low-Pressure Air Test Method) or ASTM F 1417 (Standard Test Method for Installation Acceptance of Plastic Gravity Sewer lines Using Low Pressure Air).
- B. Deflection testing of gravity sewer lines shall be conducted after completion of final backfill and grading for piping installed in areas that will not be paved. In areas where gravity sewer piping is installed beneath paving, deflection testing shall be conducted after subgrade preparation is completed. Such initial testing shall be conducted 30 days or longer after piping has been inspected and backfilled. In the event of a failed test, the line will be repaired and retested 30 days after the backfill has been replaced. No pipe shall exceed a deflection of 5%. The deflection test shall be conducted using a rigid ball or mandrel having an inside diameter equal to 95% of the

- inside diameter of the pipe. The test shall be performed without mechanical pulling devices, and shall be in accordance with the requirements of the Texas Commission on Environmental Quality.
- C. Sanitary sewer force mains shall be hydrostatically tested similarly to gravity sewer lines with the exception that force mains shall be hydrostatically tested at 150 PSI for a minimum of four (4) hours in lieu of low pressure air testing. Air release valves shall be isolated by closing the gate valve installed between them and the force main during pressure testing. Maximum allowable leakage for force mains having rubber gasketed joints shall be in accordance with Texas Commission for Environmental Quality (TCEQ) Standards.
 - D. Manholes shall be made watertight and shall be tested, independently of the wastewater lines by hydrostatic ex-filtration testing or vacuum testing, to ensure that no leakage is present. All tests shall be conducted after back fill of the manhole. If a manhole fails a leakage test, the manhole shall be made watertight and retested. Testing shall be accomplished in accordance with the requirements of the Texas Commission on Environmental Quality's "Design Criteria for Sewerage Systems".
 - E. In addition to deflection and pressure testing, the City Engineer may require that certain sewer installations be videoed after completion of construction if necessary to ensure that City requirements are met.
 - F. Copies of all test results shall be given to the City and any Municipal Utility District with jurisdiction with the project closeout documents.

6.10 EXISTING FACILITY CROSSINGS

- A. Installation of a sanitary sewer line across a proposed or existing highway, county road, public street, railroad, pipeline, or drainage way shall conform to the requirements of Section 6.11.

6.11 ADDITIONAL STANDARDS

- A. Construction Features - In conjunction with the design, the engineer shall determine the extent of, and fully detailed on the plans, all special construction features required to complete the project in a safe, convenient, and economic manner.
- B. Bore and Jack - Bore and jack sections shall be specifically approved by the Department of Public Works and clearly shown on plans by location and footage. Refer to the City of Richmond Standard Details. The following criteria are generally used as a basis for setting bore and jack sections.
 - 1. Public Streets - All existing public streets are to be bored and jacked regardless of surface. Bore and jack length shall be computed as roadway width at proposed bore plus five feet (5') to either side.
 - 2. Driveways - Whenever it is cost effective, concrete driveways in good condition shall be bored and jacked. Bore and jack length shall be computed as driveway width at bore plus one foot (1') to either side. Where driveways cross culvert pipe sections along open ditch streets and the proposed wastewater main is in close proximity and parallel to the culvert pipe, the length of bore shall be the same as the length of culvert pipe.
 - 3. Sidewalks - When the wastewater line crosses under a sidewalk four feet (4') or more in

width and in good condition, the sidewalk shall either be bored and jacked or the sidewalk shall be removed and replaced to the City of Richmond criteria, whichever is most cost effective. Bore and jack length shall be at least the width of the sidewalk. The proposed type of construction shall be noted on the plans.

4. Trees - When saving trees and shrubs in a previously developed area is a consideration, all trees six inches (6") and larger in diameter within ten feet (10') of the centerline of the water and wastewater main must be noted on the plans. The water and wastewater main shall be bored and jacked within the drip line of any tree larger than six inches (6") in diameter.
 5. Bore Pits - Bore pits shall be at least three feet (3') from back of curb and five feet (5') from back of curb on a major thoroughfare. Bore pits in highway, county road, or railroad right-of-way shall conform to these requirements and to the requirements of the crossing permit and/or use agreement. All bore pits shall be shored in accordance with OSHA requirements. Bore pits and/or receiving pits to be located in street or driveway paving, shall be shown on plans. All bore pits to be compacted to a minimum of ninety-five percent (95%) of Standard Proctor Density and tested.
 6. Open Cuts – Open cuts require specific approval of the Department of Public Works. Where open cuts are allowed in street paving, plans shall call for steel plate covers to be installed and maintained over the cut during periods when contractor is not actively engaged in work at the site. Streets that are open cut shall be "saw cut" prior to pavement removal. Saw cut shall be full depth.
- C. All existing developed areas shall be restored to original condition after construction.
- D. Proper barricading and signage, conforming to the Texas Manual of Uniform Traffic Control Devices' latest edition, shall be required on all projects. Adequate signage for vehicular and pedestrian traffic shall be installed. A traffic control plan shall be submitted to the City of Richmond and approved by the Department of Public Works for all streets open to travel by the public.

END OF CHAPTER



City of Richmond

Design Manual

Chapter 7

STORM WATER SYSTEM DESIGN REQUIREMENTS

CHAPTER 7

STORM WATER SYSTEM DESIGN REQUIREMENTS

7.01 GENERAL

- A. This chapter includes the minimum design requirements for public and private storm water systems within the city limits and the extra-territorial jurisdiction of the City of Richmond.
- B. The Richmond Public Works Department shall approve storm water system plans for all public improvements within the Richmond city limits or extraterritorial jurisdiction. Construction shall conform to the City of Richmond Construction Details.
- C. Construction plans for private improvements, within public right-of-ways and public easements or that connect to or affect the public infrastructure shall be approved by the City of Richmond subject to the requirements of this manual and are subject to review and approval using the process defined in this manual.
- D. Design, construction and sizing of all storm water systems shall meet or exceed the requirements of the City of Richmond and Fort Bend County Drainage District, as applicable, and all other entities having jurisdiction.
- E. All drainage systems that are to become a maintenance responsibility of the City of Richmond shall be enclosed storm sewers, except as specifically approved by the Department of Public Works.
- F. Public storm sewers are defined as sewers and appurtenances that provide drainage for a public right-of-way, or more than one private tract, are located in public right-of-way or easement and have been accepted by the City. Private storm sewers provide internal drainage for reserves or tracts within the private development. Private storm sewer connections to public storm sewers shall occur at a manhole or at the back of an inlet as approved by the Department of Public Works. All private storm sewers within the public right-of-way shall be constructed in conformance with these Standards.
- G. All calculations and design drawings shall be prepared under the supervision of a Professional Engineer trained and licensed under the disciplines required by the project scope. The final design drawings and all design calculations must be sealed, signed, and dated by the Professional Engineer responsible for the development of the drawings.
- H. All final plats shall contain minimum slab elevation, with reference to the most current vertical datum from the most current FEMA floodmaps.
- I. All open ditch subdivision shall include driveway culvert size information on overall site plan. Flow lines of the culverts shall be set according to the overall design of the subdivision.

7.02 DEFINITIONS

- A. **Conduit** - Any open or closed device for conveying flowing water.

- B. **Drainage Area Map** - Area map of watershed that is subdivided to show each area served by each subsystem.
- C. **Hydraulic Grade Line** - A line representing the pressure head available at any given point within the drainage system.
- D. **Redevelopment** - A change in land use that alters the impervious cover from one type of development to either the same type or another type, and takes advantage of the existing infrastructure in place as a drainage outlet.
- E. **In-fill Development** - Development of open tracts of land in areas where the storm drainage infrastructure is already in place and takes advantage of the existing infrastructure as a drainage outlet.
- F. **Rational Method** - A method for calculating the peak run-off for a storm drain system using the following equation for run-off, typically utilized for drainage areas of less than 200 acres.
- G. **Design Storm Event** - Rainfall intensity upon which the drainage facility will be sized.
- H. **Positive Overflow Pathway** - The surface flow, through designated routes, of the collective sheet flow of stormwater that results when the minor drainage system has reached capacity.
- I. **Rainfall Frequency** - Probability of a rainfall event of defined characteristics occurring in any given year. The National Weather Service publishes information on rainfall frequency. For the purpose of storm drainage design, the following frequencies are applicable:
1. 2-year frequency - a rainfall intensity having a 50 percent probability of occurrence in any given year, or nominally likely to occur once every 2 years.
 2. 3-year frequency - a rainfall intensity having a 33 percent probability of occurrence in any given year, or nominally likely to occur once every 3 years.
 3. 5-year frequency - a rainfall intensity having a 20 percent probability of occurrence in any given year, or nominally likely to occur once every 5 years.
 4. 10-year frequency - a rainfall intensity having a 10 percent probability of occurrence in any given year, or nominally likely to occur once every 10 years.
 5. 25-year frequency - a rainfall intensity having a 4 percent probability of occurrence in any given year, or nominally likely to occur once every 25 years.
 6. 100-year frequency - a rainfall intensity having a 1 percent probability of occurrence in any given year, or nominally likely to occur once every 100 years.
- J. **Sheet Flow** - Overland storm run-off that is not conveyed in a defined conduit and is typically in excess of the capacity of the conduit.
- K. **Manning's Equation:** $V = (K/n) R^{2/3} S_f^{1/2}$
 Where: K = 1.49 for English units,
 1.0 for metric units

V = velocity (ft./sec or m/sec)
R = hydraulic radius (ft. or m) (area/wetted perimeter)
S = friction slope (headloss/length)
n = 0.013 for concrete pipes,
0.024 for CMP pipes

- L. **Continuity Equation:** $Q = VA$
Where: Q = discharge (cfs or cms)
V = velocity (ft/sec or m/sec)
A = cross sectional area of conduit (square feet or square meters)
- M. **FEMA** - Federal Emergency Management Agency.
- N. **FBCDD** – Fort Bend County Drainage District.

7.03 DESIGN REQUIREMENTS

- A. Storm Water Goals: The goal of all drainage design within the city limits and the extra-territorial jurisdiction of Richmond is the prevention of structure flooding and the maintenance of one lane passable in each direction on major thoroughfares during a 100-year storm event. This is accomplished through application of various drainage enhancements, such as storm sewers, roadside ditches, open channels, detention and overland (sheet) run-off. The combined system is intended to prevent structural flooding from extreme events up to a 100-year storm. Recognizing that each site has unique differences that can enhance the opportunity to provide proper drainage, the intent of these criteria is to specify minimum requirements that can be modified provided that the objective for drainage standards is maintained. Street ponding of short duration is anticipated and designed to contribute to the overall drainage capability of the system. Storm sewers and roadside ditch conduits are designed as a balance of capacity and economics. These conduits are designed to convey less intense, more frequent rainfalls with the intent of allowing for traffic movement during these events. When rainfall events exceed the capacity of the storm sewer system, the additional run-off shall be stored or conveyed overland in a manner that reduces the threat of flooding to structures and maintains mobility on major thoroughfares. All storm water systems shall also be designed to be in conformance with the City of Richmond Storm Water Quality Manual.
- B. All drainage projects within the City shall be tied to a National Geodetic Survey (NGS) and a datum adjustment shall be provided, if necessary, between the NGS datum and the governing FEMA Flood Insurance Rate Map.
- C. Drawing sets shall include a drainage area map, which will contain calculations of flow by the rational method.
- D. Drainage systems for curb-and-gutter pavements shall be underground closed conduits; individual residential lot drainage is exempt. Drainage systems for pavements without curb and gutter shall be roadside open-ditch sections. Open-ditch drainage requires specific approval of the Department of Public Works.
- E. Storm water systems shall be designed in accordance with the FBCDD Criteria Manual as appropriate for the location of the property. Other criteria may be submitted for consideration by variance. It is the submitter's responsibility to fully justify any requested variance.

- F. The system hydraulic calculations for the storm sewer design storm and the 100-year storm, including design storm hydraulic grade line calculations, sealed by a Texas Registered Professional Engineer, shall be provided with all storm water system plans. An electronic spreadsheet shall be submitted showing pipe sizes, material, design criteria and calculations for each section (manhole-to-manhole) of the storm water system.
- G. Private storm water systems along private streets shall be designed to the standards of public storm water systems.
- H. The lowest chord of all bridges shall be a minimum of twelve inches (12") above the 100-year water surface elevation, or, at or above the level of natural ground, or in accordance with the Federal Emergency Management Agency (F.E.M.A.) regulations latest revisions, whichever is greater.
- I. All storm sewer designs and drainage plans for new developments shall include protection from the 100-year storm event through the use of positive overflow pathways. All positive overflow pathways for extreme events shall be contained within exclusive reserves and shall not be part of a residential lot unless the 100-year event is contained within a below grade conduit. If the 100-year event is contained within a below grade conduit, then the conduit shall be within the right-of-way and/or an exclusive storm sewer easement as outlined in Section 7.05.

7.04 STORM SEWER DESIGN REQUIREMENTS

A. Design Frequency

- 1. Newly Developed Areas: The minimum design storm event for sizing storm sewers in newly developing areas will be in accordance with the current, applicable county drainage manual.
- 2. Redevelopment or In-fill Development: The existing storm drain will be evaluated using the requirements of Fort Bend County drainage design manual assuming no development takes place. The storm drain will then be evaluated with the development in place.
 - a. If the proposed redevelopment has a lower or equal impervious cover, no modifications to the existing storm drain are required.
 - b. If the hydraulic gradient of the existing storm drain is below the top of curb, no improvements to the existing storm drain are required.
 - c. If the hydraulic gradient is above the top of curb, and no structures are threatened, the applicant must check with the City to see if a Capital Improvement Project is proposed that will require a capital contribution. If no Capital Improvement Project is in place for the subject system and no structural flooding is threatened by the project and the amount of street ponding meets City criteria, then no improvements to the existing storm drain are required.
 - d. If the hydraulic gradient indicates that structures are threatened by flooding, the applicant has the option of either making improvements to the existing storm drain or providing on-site detention.

- B. Storm sewers shall have a minimum clearance of six inches (6") from all other utilities. The

clearance shall be measured from the outside wall of the pipe.

- C. Design storm runoff shall be calculated in accordance with the “Drainage Criteria Manual for Fort Bend County, Texas”.
- D. Minimum depth of a storm sewer (measured to the top of pipe) shall be twenty-four inches (24”) below top of curb or finished grade, whichever is lower.
- E. Minimum size storm sewer for main and inlet lead shall be twenty-four inch (24”).
- F. Storm sewers shall be bedded using cement stabilized sand compacted to 95% as shown in the City of Richmond Standard Construction Details.
- G. Pipe Material Considerations
 - 1. Storm sewer and culvert pipe shall be precast reinforced concrete pipe, unless specifically approved by the Department of Public Works. Concrete pipe shall be manufactured in conformance with the requirements of ASTM C 76, “Reinforced Concrete Culvert, Storm Drain, and Sewer Pipe”, current revision. Reinforced concrete pipe shall be Class III or stronger. The design engineer shall provide for increased pipe strength when conditions of the proposed installation exceed the allowable load for Class III pipe. All concrete pipe forty-two inches (42”) or larger shall have rubber gasket joints meeting the requirements of ANSI/ASTM C 443, “Joints for Circular Concrete Sewer and Culvert Pipe, Using Rubber Gaskets”, current revision. When specifically approved by the Department of Public Works, reinforced concrete arch and elliptical pipe conforming to ASTM C506 and C507, respectively, current revision may be installed in lieu of circular pipe. Reinforced concrete box culverts shall meet the minimum requirements of ASTM C1433, “Precast Reinforced Concrete Box Sections for Culverts, Storm Drains, and Sewers”, current revision. Box culvert joints may be sealed with rubber gaskets meeting the requirement of ASTM C1677 “Joints for concrete box culverts using rubber gaskets” or the joint may be sealed with RAM-nek. Pipe joints for arch and elliptical pipe shall be sealed using RAM-nek or approved equal. For equals, refer to the City of Richmond Approved Products List.

- 2. Reinforced concrete pipe, as described in Section 7.04 G.1 shall meet or exceed the following minimum requirements:

Pipe Class	Maximum Cover (Feet)
III	15
IV	30

Reinforced concrete pipe installed at a depth greater than thirty feet (30’) shall be designed by the engineer for the specific installation and approved by the Department of Public Works. Reinforced concrete pipe shall be designed in accordance with the American Concrete Pipe Association, “Concrete Pipe Design Manual”. Maximum cover

on the pipe shall be measured from the top of pipe to the ultimate finished grade or natural ground, whichever is greater.

3. Storm sewer outfalls into open channels shall be constructed using corrugated steel pipe. Corrugated steel pipe shall be manufactured in conformance with the requirements of AASHTO Designation M-36, M-218 & M-190, current revisions. Pipe material shall be Pre-coated Galvanized Steel, AASHTO M-246, minimum 10-mil coating on both sides. Pre-coated Galvanized Steel pipe shall have a full double coating, Type A, in accordance with AASHTO Designation M-190, current revision. Pipe joints and fittings shall meet the minimum requirements of these specifications and shall have an O-ring gasket seal meeting the requirements of AASHTO C-361, current revision. (See the City of Richmond Construction Details). Aluminized steel pipe is not allowed. Galvanized pipe shall be asphalt-coated for all outfall and back-slope drain structures.
4. Corrugated steel pipe shall have a minimum thickness as follows:

Pipe Size (Inches)	Corrugations	Minimum Thickness (Inches)
24	2-2/3" X 1/2"	0.064
30 - 48	2-2/3" X 1/2"	0.064
54 - 72	3" x 1" or 5" X 1"	0.064
78 - 102	3" x 1" or 5" X 1"	0.079

Bedding for corrugated steel pipe shall be cement stabilized sand and shall have a minimum density of ninety-five percent (95%) Standard Proctor. Corrugated steel pipe less than thirty feet (30') deep shall have the minimum thickness given above. Corrugated steel pipe larger than fifty-four inches (54") in diameter and greater than thirty feet (30') deep shall be designed by the engineer for the specific installation and approved by the Department of Public Works. Corrugated steel pipe shall be designed in accordance with the American Iron and Steel Institute, "Handbook of Steel Drainage and Highway Construction Products".

5. Storm sewer outfalls shall have slope protection to prevent erosion. Outfall design shall conform to FBCDD standards, as appropriate. Slope protection may be constructed of slope paving. Slope paving shall be four-inch (4") thick, five and a half (5½) sack concrete with one-half inch (1/2") steel rebar on twenty-four-inch (24") centers, each way. Slope protection texturing shall be required where public access is likely. Refer to the City of Richmond Standard Construction Details for minimum dimensions.
6. Private storm sewer systems may be reinforced concrete pipe, high-density polyethylene pipe, PVC pipe of minimum SDR 26 rating or A-2000 PVC pipe. Reinforced concrete pipe is required within the public right-of-way and public easements.

H. Velocity Considerations

1. Storm sewers shall be constructed to flow in sub-critical hydraulic conditions if possible.
2. Minimum velocities shall not be less than 3 feet per second with the pipe flowing full, under the design conditions.

3. Maximum velocities shall not exceed 8 feet per second without use of energy dissipation downstream.
4. Maximum velocities shall not exceed 10 feet per second.
5. Minimum acceptable slopes in reinforced concrete pipe storm sewers shall be:

Size of Pipe (Inches)	Fall in Feet (Per 100 Feet of Sewer)
24	0.18
30	0.13
36	0.10
42	0.08
48	0.07
54	0.06
60	0.05
66	0.045
72	0.040
18	0.036
84	0.033
90	0.030
96	0.028

I. Pipe Sizes and Placement

1. Use storm sewer and inlet leads with at least 24-inch (24") inside diameter or equivalent cross section within the public right-of-way or along private streets. Box culverts shall be at least 2 feet by 2 feet (2' x 2'). Closed conduits; circular, elliptical, or box, shall be selected based on hydraulic principals and economy of size and shape.
2. Larger pipes upstream should not flow into smaller pipes downstream unless construction constraints prohibit the use of a larger pipe downstream, or the improvements are outfalling into an existing system, or the upstream system is intended for use in detention.
3. Match crowns of pipe at any size change unless depth constraints or other conditions justify matching flow-lines.
4. Locate storm sewers in public street rights-of-way or in approved easements.
5. All storm sewers and inlet leads shall be laid in a straight line. Changes of alignment shall be accomplished at manholes only.
6. Center storm sewers in side lot storm sewer easements.

J. Consideration of Overland Flow

1. All storm sewer designs shall include provisions for an overland positive overflow pathway to accommodate storm water that exceeds the capacity of the storm sewer system.

2. Design Frequency: Design frequency for consideration of overland sheet flow shall consider extreme storm events that exceed the capacity of the underground storm sewer system resulting in ponding and overland sheet flow through the development to the primary outlet. The minimum design frequency for overland sheet flow shall be the 100-year design storm.
3. Relationship of structures to street or parking lot ponding: All structures shall be a minimum of eighteen inches (18") higher than the highest level of ponding anticipated resulting from the extreme event analysis.
4. Calculation of Flow
 - a. Streets shall be designed so that consecutive high points in the street will provide for a gravity flow of drainage to the ultimate outlet.
 - b. For non-major thoroughfare streets, the maximum depth of ponding at any point on the gutter line shall be a maximum of eighteen inches (18") above the gutter line.
 - c. Sheet flow between lots can be provided only through a defined drainage easement. All positive overflow pathways for extreme events shall be contained within exclusive reserves and shall not be part of a residential lot unless the 100-year event is contained within a below grade conduit. If the 100-year event is contained within a below grade conduit, then the conduit shall be within the right-of-way and/or an exclusive storm sewer easement as outlined in Section 7.05.
 - d. A map shall be provided to delineate extreme event flow direction through a proposed development and how this flow is discharged to the primary drainage outlet.
 - e. In areas where ponding occurs and no positive overflow pathway exists, then a calculation shall be provided showing that run-off from the 100-year event can be conveyed and remain in compliance with the other requirements of this section.

K. Consideration of Street Ponding

1. Design storm flow shall meet Fort Bend County criteria. The storm sewer system must convey flows from a 100-year storm event without ponding water in the street at levels that exceed the maximum allowable level. Street ponding elevations shall be shown on the drainage area map and/or the plan and profile sheets in all construction plans. Street ponding for the 100-year storm shall not exceed the following.
 - a. The maximum allowable ponding level for a minor or collector street is the lowest of the following: 1) 1' above natural ground; 2) 18" above the gutter line; or 3) 1' below the lowest slab elevation for a 100-year storm event.
 - b. The maximum amount of ponding allowed on a major thoroughfare is twelve inches (12") above the outside (non-median) gutter line. For a major thoroughfare, the minimum median top of curb elevation shall be at or above

the 100-year flood plain elevation.

2. Drainage calculation, along with water surface or hydraulic grade line profiles shall be submitted to the City Engineer for approval.

L. Starting Water Surface and Hydraulic Gradient

1. The hydraulic gradient shall be calculated assuming the greater of the top of the outfall pipe or the 25-year design storm water surface elevation as the starting water surface.
2. At drops in pipe invert, should the upstream pipe be higher than the hydraulic grade line, then the hydraulic grade line shall be recalculated assuming the starting water surface to be at the top of pipe at that point.
3. For the Design Storm, the hydraulic gradient shall at all times be below the gutter line for all newly developed areas.

M. Manholes

1. Manholes shall be installed at the following locations:
 - a. Size or cross-section changes of storm sewers.
 - b. Inlet leads and storm sewer intersections.
 - c. Changes in pipe grade or alignment.
 - d. Street intersections.
 - e. A maximum spacing of 500 feet measured along the conduit run.
2. Use manholes for existing monolithic-concrete storm sewers at the same locations as above except for intersections of inlet leads unless a manhole is needed to provide maintenance access at those intersections.
3. Manholes shall be placed on lot lines to the maximum extent practical. Do not place manholes in driveways or in the street in front of, or immediately adjacent to, a driveway.
4. Manhole covers shall be cast iron, traffic bearing, type ring and cover with the words “Storm Sewer” and “Dump No Waste” cast into the cover with Richmond emblem in center (see standard details).

N. Inlets

1. Inlet capacity for the design storm shall be computed using a maximum water surface elevation equal to the top of curb at the inlet. Design capacity for inlets shall not exceed the capacities below.

Inlet	Typical Application	Maximum Capacity (cfs)
Type A	Parking Lots / Small Areas	2.5
Type B-B	Residential / Commercial	5.0
Type C	Residential / Commercial	5.0

Type C-1	Commercial	10.0
Type C-2	Commercial	15.0
Type C-2A	Commercial	20.0
Type D	Parking Lots	2.0
Type D-1	Small Areas	2.5
Type E	Swales / Roadside Ditches	20.0
Type H-2	Residential / Commercial	5.0

2. Type B-B inlets are not allowed for new construction unless approved by City Engineer.
 3. Curb inlets shall be spaced and sized to intercept the calculated runoff for the design storm. The water surface elevation at the inlet shall be less than or equal to the gutter line for the design storm flow.
 4. Do not use beehive grate inlets or other specialty inlets.
 5. Do not use grate top inlets in unlined roadside ditch.
 6. Do not locate inlets adjacent to esplanade openings without prior approval.
 7. Place inlets on side streets intersecting major streets, unless justification based on special conditions can be provided.
 8. Connections shall not be made to the short sides of the inlet. Design the connection not to exceed the outlet pipe capacity minus the greater of either the capacity listed in Section 7.04 N. 1, or the calculated inlet inflow.
 9. For all new construction, convey public or private alleyway drainage to an inlet prior to entering the public street drainage system.
 10. Locate inlets at low points in the gutter.
 11. Valley gutters across intersections are not permitted.
 12. Maximum travel distance of water in the street to a curb inlet shall be three hundred feet (300') on a major thoroughfare and in a commercial area. The maximum travel distance of water in the street permitted in a single-family residential area shall be six hundred feet (600').
 13. Backslope swale interceptors shall be placed in accordance with the requirements of Fort Bend County.
 14. Backfill around inlets with 2.0 sacks per ton of cement stabilized sand to the bottom of the pavement subgrade.
- O. Public storm sewers shall be located within a public street right-of-way or a storm sewer easement, dedicated to the public and adjoining a public street right-of-way. Public storm sewers

shall not be allowed in back lot easements.

- P. Storm Sewer alignment within a public street right-of-way.
1. Storm sewers shall be located within the median, centerline of the right-of-way, along boulevard pavement sections.
 2. Undivided pavement section: Five feet (5') inside the right-of-way. For all storm sewers located in a public street right-of-way, a minimum distance of two feet (2') shall be maintained inside the right-of-way line to the outside edge of the storm sewer unless otherwise accompanied by an adjacent easement.
 3. Alternate locations for a storm sewer require specific approval of the Department of Public Works.

7.05 STORM SEWER EASEMENT REQUIREMENTS

- A. Storm Sewer Easements - the following minimum easement widths are required:
1. The minimum width shall be equal to the depth to the flowline plus two pipe diameters or fifteen feet (15'), whichever is greater, with the storm sewer centered in an exclusive easement, except as specifically approved by the Department of Public Works.
 2. For storm sewers, or combinations thereof, greater than ten feet (10') and less than fifteen feet (15') in diameter or width, the minimum width of an exclusive easement shall be equal to the pipe depth plus two pipe diameters, rounded up to the nearest five foot increment.
 3. For storm sewers, or combinations thereof, greater than fifteen feet (15') in diameter or width, the minimum width of an exclusive easement shall be determined by the Department of Public Works.
 4. For storm sewers whose depth to flow line is greater than fifteen feet (15'), add five feet (5') to the minimum easement width specified in section 7.05 A.1 and Section 7.05 A. 2, above.
 5. For all easements specified in section 2.4.6, a minimum distance of five feet (5') must be maintained from the easement line to the outside edge of the storm sewer.
 6. Where approvals are granted for a special use or combination easement located along side lot, the minimum width shall be determined on a case-by-case basis and subject to approval of the City Engineer.
 7. A drainage reserve in lieu of easement is required, with the width meeting or exceeding all easement requirements. Variation from this standard requires City Engineer's approval. Ownership of the reserve must be indicated on the plat.
 8. For specifically approved storm sewers located in an exclusive easement adjacent to public rights-of-way, the minimum easement width shall be ten feet (10'). The easement width shall meet or exceed all other easement requirements.

B. Alignment within an exclusive storm sewer easement.

1. Storm sewers placed in easements shall be located along the centerline of the easement, unless otherwise approved by the Department of Public Works or as required in Section 7.05.
2. Storm sewers within easements shall be placed no closer than five feet (5') measured from the outside edge of the pipe to the edge of an easement, except when adjoining another easement or public right-of-way where the distance may be reduced to two feet (2'). The storm sewer shall be placed in the center of the easement. When the storm sewer easement adjoins a public right-of-way, the easement may be reduced to a minimum of ten feet (10') and the storm sewer may be aligned closer to the right-of-way line, as long as required clearances are met, with specific approval of the Department of Public Works.

7.06 OPEN CHANNEL DESIGN AND ROADSIDE DITCHES REQUIREMENTS

A. Design of Open Channels.

1. Open channels shall be designed according to methods described in the FBCDD Criteria Manual.
2. Design standards for channel construction shall follow the requirements specified in the FBCDD Criteria Manual.
3. Design standards for outfalls into channels shall conform to those in the FBCDD Criteria Manual.

B. Design of Roadside Ditches.

1. Roadside ditch design is permissible only for single-family residential lots with individual tracts equal to or larger than 1 acre.
2. The design storm event for the roadside ditches shall be a minimum of 2-year rainfall.
3. Design capacity for a roadside ditch shall be to 0.5 feet below the edge of pavement or the natural ground at the right of way line, whichever is lower.
4. The design must include an extreme event analysis to indicate that structures will not be flooded.
5. Velocity Considerations.
 - a. For grass-lined sections, the maximum design velocity shall be 3.0 feet per second during the design event.
 - b. A grass-lined or unimproved roadside ditch shall have side slopes no steeper than three horizontal to one vertical (3:1), or as soil conditions will permit.
 - c. Minimum grades for roadside ditches shall be 0.1-foot per 100 feet.

- d. Calculation of velocity will use a Manning's roughness coefficient (n) of 0.04 for earthen sections and 0.015 for concrete lined ditches.
 - e. Use erosion control methods acceptable to the City when design velocities are expected to be greater than 3 feet per second.
6. Determination of Water Surface Elevation.
- a. Water surface elevations shall be calculated using Manning's Equation and the Continuity equation.
 - b. For the design storm event, the water surface shall be calculated to remain within banks.
7. Design of Culverts.
- a. Head losses in culverts shall conform to TxDOT Hydraulics Manual, Chapter 4, Culverts.
 - b. Residential culverts shall be per the approved products list, installed in accordance with the Richmond Standard Details. Corrugated metal pipe will only be approved for railroad crossings. All driveway installations may include safety end treatments.
 - c. Culverts will be placed at all driveway and roadway crossings, and other locations where appropriate.
 - d. Roadside culverts are to be sized based on drainage area. However, the minimum culvert sizes within a residential subdivision shall be no less than fifteen inches (15"). Calculations shall be provided for review. The size of culvert used shall not create a head loss of more than 0.20 feet greater than the normal water surface profile without the culvert.
 - e. Storm water discharging from a ditch into a storm sewer system must be received by use of an appropriate structure (i.e., stubs with ring grates or Type E inlets).
8. Invert Protection.
- a. Ditch invert protection shall be used when velocities exceed 3 feet per second.
 - b. Ditch invert protection will be used at the upstream and downstream ends of all culverts.
9. Depth and Size Limitations.
- a. Maximum depth shall not exceed five feet (5'), measured from adjacent edge of pavement.
 - b. Roadside ditch bottoms shall be at least 2 feet (2') wide, unless design analysis will support a narrower width.

- c. Ditches in adjoining and parallel easements shall have top of bank not less than two feet (2') from the outside easement line.

10. Location of Roadside Ditches

- a. Roadside ditches shall be completely contained within the road right-of-way.
- b. There shall be a minimum distance of four feet (4') from the edge of pavement and the inside high bank of roadside ditches. There shall be a minimum distance of two feet (2') between the outside high bank of the ditch and the road right-of-way.
- c. Roadside ditch side slopes shall not exceed 3 H :1 V.

7.07 STORM WATER DETENTION REQUIREMENTS

- A. The intention of storm water detention is to mitigate the effect of the new development on an existing drainage system. An engineer may provide calculations using acceptable design criteria to show that the impact can be mitigated using detention criteria different from the requirements of the FBCDD Criteria Manual.
- B. Application of Detention

All development/redevelopment must be designed in a way that mitigates the effects of the development on other properties. In other words, post-development peak runoff for the design storm(s) event must be less than or equal to pre-development peak runoff. This will be accomplished through the use of on-site storm water detention facilities designed to mitigate storms up to and including the 100-year (1%) event. In some watersheds where mitigation is performed on a regional basis, individual detention sites may not be required. It is the responsibility of the project owner to coordinate with City staff to determine whether regional detention or individual mitigation facilities are necessary for the development.

The use of on-site detention is required when reported incidence of structural flooding exists, or when in-fill or redevelopment will result in a potential threat to existing structures unless the current infrastructure is improved, or when detention is required in accordance with the appropriate, adopted watershed master drainage plan, when post development flows result in street ponding levels which exceed City requirements, or if in the opinion of the City Engineer post development flows will have an adverse impact on adjacent properties. If the City has developed a plan for a regional detention facility to serve a watershed, then the development is responsible for all costs of constructing the system to convey flows from their project to the regional facility. The City may elect to participate in oversizing of this conveyance if regional drainage interests are served.

When development occurs within the 100-yr floodplain, compensatory storage within the detention pond is required to offset the amount of fill placed within the regulatory floodplain.

Detention may not be required under the following conditions.

- 1. If redevelopment occurs without increasing the overall impervious character of the site,

then no detention will be required by the City unless the application of detention will prevent existing structure flooding or bring the street ponding level on a major thoroughfare to within City requirements.

2. If the proposed development has less or equal impervious land cover than that used in the design of the storm sewer system as shown on the drainage area map in the roadway construction plans or other hydraulic computations.
 3. If the hydraulic grade line from the current design storm of the receiving storm sewer system remains below the elevation of the gutter throughout the system with the proposed development included and considering ultimate conditions of the storm sewer watershed.
- C. Detention volume for redevelopment areas is calculated on the basis of the amount of area of the redeveloped impervious cover.
- D. Private parking areas, private streets, and private storm sewers may be used for detention provided the maximum depth of flooding does not exceed six inches (6") directly over the inlet. Underground detention facilities may be proposed for consideration by the City.
- E. Calculation of Outlet Size.

1. Detention pond discharge pipe into an existing storm sewer line or existing City of Richmond or other public entity facility:

- a. Maximum pool elevation at or below the design hydraulic grade at the outfall -
The discharge line shall be sized for the Design Storm with the outfall pipe flowing full. The pond will float on the drainage system to provide maximum benefit.

- b. Maximum pool elevation at or above the hydraulic grade at the outfall – Provide a reducer or restrictor pipe to be constructed inside the discharge line. The discharge line shall be sized for the Design Storm with the outfall pipe flowing full.

- c. Reducer or Restrictor Pipes shall be sized as follows:

- (1) The reducer or restrictor will be sized for undeveloped rate of discharge at no greater than 0.5 cubic feet per second per acre unless capacity for a greater flow rate is verified in the receiving system and approved by the City Engineer.

- (2) Use the following equations to calculate the required outflow orifice:

$$Q = CA (2g)^{1/2} (h)^{1/2}$$

$$D = Q^{1/2} / (2.25 h)^{1/4}$$

Where:

Q = outflow discharge (cfs)

C = 0.8

A = orifice area (square feet)

g = gravitational factor (32.2)

h = head, water surface differential (feet)

D = orifice diameter (feet)

- (3) Restrictor shall be either of the required diameter or of the equivalent cross-sectional area. The orifice diameter D shall be a minimum of 0.5 feet.
- a. In addition to a pipe outlet, the detention basin shall be provided with a gravity spillway that will protect structures from flooding should the detention basin be overtopped.
- b. Detention ponds shall maintain a minimum freeboard of one foot (1') between the top of bank and the 100-year water surface elevation.
- c. All outfall pipe configuration must conform to the slope of the receiving ditch and provide slope/erosion protection.

F. Detention Facility Ownership and Easements.

1. Private Facilities:

- a. Pump discharges into a roadside ditch require the submittal of pump specifications on the design drawings. The maximum discharge rate of pumped facilities to a roadside ditch is 0.5 cubic feet per second unless capacity for a greater flow rate is verified in the receiving system and approved by the City Engineer. Energy dissipaters and erosion protection is required for pumped outfalls. Pump station shall include a back-up pump and emergency power source, and be designed in accordance with Fort Bend County Drainage District requirements.
- b. The City reserves the right to prohibit the use of pump discharges where their use may aggravate flooding in the public right-of-way.
- c. Responsibility for maintenance of the detention facility must be indicated on recorded plat or by letter submitted to the City as part of the design review.
- d. All private properties being served have drainage access to the pond. Dedicated easements may be required.
- e. No public properties drain into the detention area.
- f. A private maintenance agreement is provided when multiple tracts are being served.

2. Public Facilities:

- a. Facilities will only be accepted for maintenance by the City in cases where public drainage is being provided.
- b. The City requires a maintenance work area of 30-foot width surrounding the extent of the detention area. Public rights-of-way, drainage reserves or permanent access easements may be included as a portion of this 30-foot width.

- c. A dedication of drainage reserve provided by plat is required. Easements may be used upon approval by City Engineer.
- d. Proper dedication of public access to the detention pond must be shown on the plat. This includes permanent access easements with overlapping public utility easements.

7.08 MINIMUM PLAT AND CONSTRUCTION PLAN REQUIREMENTS

- A. Submittal, for review and comment, of one-line drawings is required as part of the platting process. One line drawings shall include at a minimum:
 - 1. The definition of lots and street patterns.
 - 2. The drainage areas for each system.
 - 3. A definition of the proposed drainage system by single line.
 - 4. The proposed pipe diameters.
 - 5. Any proposed or existing drainage easements or rights-of-way.
 - 6. Floodplain information, including floodplain boundary, if any; FEMA map number, effective map date and zone.
 - 7. Sealed supporting engineering calculations for the design storm and the extreme event.
 - 8. Analysis of the extreme event and consideration of positive overflow pathways.
 - 9. Detention analysis and calculations where required.
- B. Minimum construction plan submittals include:
 - 1. A drainage area map shall be included in the construction plans. The drainage area map shall include:
 - a. Drainage areas, including areas draining from off-site onto or adjoining the project.
 - b. Design storm runoff.
 - c. 100-year storm runoff.
 - d. Route of overland flow including the overflow to a drainage way sized to accommodate the 100-year flow.
 - e. Elevations for the 25-year and 100-year storms in the outfall channel.
 - f. Flow per inlet.
 - g. Maximum 100-year ponding elevation.
 - h. Street ponding elevations for the 100-year event.
 - i. Supporting calculations.
 - 2. Copies of any documents that show approval of exceptions to the City design criteria.

3. Design calculations for storm line sizes and grades, and for detention facilities, if any.
 4. Design calculations for the hydraulic grade line of each line or ditch, and for detention facilities, if any.
 5. Existing contour maps and final grading plans of the project.
 6. Plan and profile sheets showing storm water design.
 7. Projects located within a floodplain boundary or within a floodplain management area shall show the floodplain boundary or floodplain area, as appropriate, on the drainage area map.
 8. Storm water detention maintenance agreement letters.
- C. All drainage calculations shall be submitted in an electronic, text file spreadsheet.

7.09 ADDITIONAL STANDARDS

- A. Construction Features - In conjunction with the design, the engineer shall determine the extent of, and fully detailed on the plans, all special construction features required to complete the project a safe, convenient, and economic manner.
- B. Bore and Jack - Bore and jack sections shall be specifically approved by the Department of Public Works and clearly shown on plans by location and footage. The following criteria are generally used as a basis for setting bore and jack sections.
 1. Public Streets - All existing public streets are to be bored and jacked regardless of surface. Bore and jack length shall be computed as roadway width at proposed bore plus two feet (2') to either side.
 2. Driveways - Whenever it is cost effective, concrete driveways in good condition shall be bored and jacked. Bore and jack length shall be computed as driveway width at bore plus one foot (1') to either side. Where driveways cross culvert pipe sections along open ditch streets and the proposed water main is in close proximity and parallel to the culvert pipe, the length of bore shall be the same as the length of culvert pipe.
 3. Sidewalks - When the storm sewer line crosses under a sidewalk, the sidewalk shall be removed and replaced to the City of Richmond criteria. The proposed type of construction shall be noted on the plans.
 4. Trees - When saving trees and shrubs in a previously developed area is a consideration, all trees six inches (6") and larger in diameter within ten feet (10') of the centerline of the storm sewer main must be noted on the plans. The storm system shall be bored and jacked within the drip line of any tree larger than six inches (6") in diameter.
 5. Bore Pits - Bore pits shall be at least two feet (2') from back of curb. Bore pits in highway, county road, or railroad right-of-way shall conform to these requirements and to the requirements of the crossing permit and/or use agreement. All bore pits shall be shored in accordance with OSHA requirements. Bore pits and/or receiving pits to be

located in street or driveway paving, shall be shown on plans.

6. Open Cuts – Open cuts require specific approval of the Department of Public Works. Where open cuts are allowed in street paving, plans shall call for steel plate covers to be installed and maintained over the cut during periods when contractor is not actively engaged in work at the site. Streets that are open cut shall be "saw cut" prior to pavement removal. Saw cut shall be full depth.
- C. All existing developed areas shall be restored to original condition or better after construction.
- D. Proper barricading and signage, conforming to the Texas Manual of Uniform Traffic Control Devices' latest edition, shall be required on all projects. Adequate signage for vehicular and pedestrian traffic shall be installed. A traffic control plan shall be submitted to the City of Richmond and approved by the Department of Public Works for all streets open to travel by the public.

END OF CHAPTER



City of Richmond

Design Manual

Chapter 8

DRIVEWAY AND ACCESS REQUIREMENTS

CHAPTER 8

DRIVEWAY AND ACCESS REQUIREMENTS

8.01 GENERAL

- A. These standards describe the general requirements for driveways and roadway access.
- B. The Richmond Public Works Department shall approve all non-residential driveway locations, widths and geometrics that connect to a public street, prior to construction, within the Richmond city limits or extraterritorial jurisdiction.
- C. A traffic impact study may be required as a part of the approval process for driveways and other roadway access in accordance with Chapter 9 of this manual. A traffic impact analysis (TIA), when required, shall be prepared by an individual, group, firm or corporation having demonstrated professional emphasis and experience in transportation planning, engineering and in the preparation of similar analyses. The TIA document shall bear the seal and signature of a Texas Registered Professional Engineer.
- D. All driveways shall be constructed in accordance with the Richmond Standard Construction Details.

8.02 DEFINITIONS

For the purposes of this chapter, the following words and phrases shall have the meanings respectively ascribed to them by this section.

Collector Streets - Street routes that have short travel distances and collect traffic from intracity streets and funnel it into major thoroughfares or other collector streets.

Development - means the new construction of any building, structure or improvement, or the enlargement of any exterior dimension of any building, structure or improvement.

Commercial Driveway Approach - The portion of a driveway within the public right-of-way that provides access to property on which an office, retail or commercial center is located, to a building having more than five dwelling units or to any driveway approach which accesses property that is primarily used for a non-residential purpose.

Driveway - Entrance to and exit from premises where it is possible to park completely off the street, and which is not open for vehicular traffic except by permission of the owner of such private property.

Driveway Approach - A way or place including paving and curb returns between the street travel lanes and private property that provides vehicular access between the roadway and said private property.

Driveway Approach Width - As the term is used here, the width of a driveway approach refers to the width of driveway pavement at the point where the property line intersects the driveway pavement.

Lot - means an undivided tract or parcel of land having frontage on a public or private street, or other approved facility contained within a block and designated on a subdivision plat by numerical or letter identification.

Intersection - The area embraced within the prolongation or connection of the lateral curb lines, or, if none, then the lateral boundary lines of two or more roadways, including public street, private street, commercial driveway, residential driveway, driveway approach, alley or combination thereof which join one another at, or approximately at, right angles, or the area within which vehicles traveling upon different roadways joining at any other angle may come into conflict.

Major Thoroughfare - Street routes that are identified as major thoroughfares as set forth in the Major Thoroughfare Plan adopted by City Council and as may from time to time be amended.

Multi-family Dwelling - means a structure containing more than two separate units for single-family occupancy.

Non-Residential Driveway Approach - A driveway which provides access to property on which an office, retail or commercial or industrial center is located, or a building having more than five dwelling units is located or any driveway approach which accesses property that is primarily used for a non-residential purpose.

Residential Driveway - means a driveway intended to provide access from a public or private street to a single adjacent detached residential unit.

Right-of-Way - Property that is publicly owned or upon which a governmental entity has an express or implied property interest (e.g. fee title, easement, etc.) held for a public purpose. Examples of such public purpose include by way of example and not limitation, a highway, a street, sidewalks, drainage facilities, sewerage and water facilities.

Street, Private - means a private thoroughfare, not dedicated to public use, which provides vehicular access from a public street to more than two residential dwelling units, or two or more commercial or industrial buildings or parking areas.

Street, Public - means any public thoroughfare or right-of-way, dedicated for public use, which provides vehicular access to adjacent land.

8.03 DESIGN REQUIREMENTS

A. Design Philosophy

Large speed differentials among motor vehicles traveling the same or connecting roadways creates unsafe driving conditions. Minimizing speed differentials through the proper design of driveway approaches promotes driver and pedestrian safety. It is the City's policy to require a driveway design that creates no more than a 20 mph maximum speed differential on roadways. The goal of the City policy is to create a balance between optimal access and safety.

Generally, as the widths of streets and vehicular speeds increase, the number of driveway approaches should decrease. Driveway approaches accessing major thoroughfares should be situated in a manner that minimizes the number of potential conflict points. A single piece of

property served by multiple driveways may increase speed differentials and is generally considered undesirable. For commercial development shared commercial driveways shall be a requirement. Regulated access, removing turning vehicles from the traffic stream and channelization of traffic should be determined on a site-specific basis, taking into consideration the policies and requirements of the City and other regulating entities, and following generally-accepted traffic engineering principles.

City policy is to require turn bays and acceleration/deceleration lanes on major thoroughfares or to utilize equally effective traffic-controlling methods that will minimize speed differential and increase overall safety.

A sight distance analysis is required for all driveways located within a horizontal or vertical curve of the frontage roadway.

- B. Driveways shall not be located within the functional areas of intersections.
- C. Driveway grades shall be minimized. The maximum algebraic change in grade of driveways allowed on all streets is eight percent (8%).
- D. At a signalized intersection in which a public street terminates at the intersection of a connecting cross street, a driveway shall not be placed on the cross street as to be in alignment with the terminating street. If the requirements for driveways otherwise allow the placement of a driveway at that location, the driveway width shall match the cross-section of the intersecting public street.
- E. Driveway approaches shall be built with a circular curb radius connecting the raised curb of the roadway to the driveway approach in accordance with the Richmond Standard Construction Details. In order that the definition of the location of the edge of pavement for the roadway may be maintained, driveway approach radii shall always be designed to become tangent to the street curb line. Driveway curb returns shall terminate within the boundaries of the lot served by the driveway. Driveway widths shall be measured between the edges of pavement or the face of curbs, as applicable, at the property/ROW line. Driveway approaches within the public right-of-way shall be constructed of the same materials as the adjacent street surface
- F. All driveways shall be designed to intersect the adjacent street at a 90-degree angle unless specifically approved by the Department of Public Works.
- G. Driveways shall not be permitted in the transition area of any right-turn lane, acceleration or deceleration lane.
- H. Driveways that intersect at a mid-block median shall have the driveway centerline intersect with the midpoint of a median opening (measured nose-to-nose).
- I. All nonconforming driveways on a lot, tract, parcel or site shall be allowed to continue until the occurrence of one or more of the following events:
 - 1. A change in use, or an increase in intensity of use, occurs such that the site requires a ten percent (10%) increase in required parking spaces.
 - 2. Any modification that changes the design or function of the existing driveway.

3. The addition of a median opening on the public street by a developer. All driveways that are served by the new median opening shall comply with the requirements of these standards.

Upon the occurrence of the events described, the nonconforming status of the driveway shall cease and the driveway either reconstructed in accordance with this ordinance, or eliminated.

Access driveways may be permitted subject to Director of Public Works approval. Permanent driveways shall only be constructed in conjunction with the issuance of building permit for the site.

8.04 SINGLE FAMILY RESIDENTIAL DRIVEWAY REQUIREMENTS

- A. No direct access to a major thoroughfare or major collector from a residential driveway approach is allowed. Access to a minor collector or local street is allowed.
- B. No lot may have more than two (2) driveways accessing the adjacent street or streets. Side lot access is not allowed within the first one hundred twenty feet (120') of a street serving as the entrance to a subdivision.
- C. Driveways shall be located a minimum of thirty-five feet (35') away from the intersection of streets, measured from the curb return of the street to the curb return of the portion of the driveway closest to the street.
- D. Circular driveways are allowed on residential lots with a street frontage of seventy feet (70') or greater. A maximum of two driveways are allowed on the street on which the seventy foot street frontage is located, provided that the driveways meet all other requirements of this chapter.
- E. Residential driveways shall have a minimum curb radius of five (5') feet. The driveway curb returns shall terminate within the boundaries of the lot served by the driveway.
- F. Residential driveway approaches shall have a minimum width of sixteen (16') feet and a maximum width of twenty (20') feet.
- G. Driveway approaches within the public right-of-way shall be constructed of the same materials as the adjacent street surface.
- H. All special, non-standard materials, such as exposed aggregate, dyed concrete, concrete pavers, etc. and special signage, that are installed by a developer, homebuilder or homeowner shall be specifically approved by the Department of Public Works and shall be maintained by the installer/owner or his assigns. Any maintenance of non-standard items by the City of Richmond will be done using standard materials and methods.

8.05 MULTI-FAMILY RESIDENTIAL REQUIREMENTS

- A. Multi-family residential developments shall meet the same driveway standards as non-residential developments.

8.06 NON-RESIDENTIAL DRIVEWAY REQUIREMENTS

- A. Adequate distance between cross street intersections and access drives shall be provided to ensure intersection/driveway conflict areas are minimized. Along either side of any corner commercial or industrial property the driveway approaches shall be located so as to maintain a minimum distance from the corner of the intersecting roadways equal to ninety percent of the length of the property along the roadway upon which the proposed driveway approach is to be located or one hundred (100) feet, whichever distance is greater. Driveways on corner lots are subject to all of the requirements of this chapter, including spacing and cross-access requirements.
- B. Non-residential driveways shall be shared among different property owners or users when necessary to maintain minimum spacing requirements. Joint-access drives shall include full drive width and access pavement and be built at the same time as the first development.

Interconnectivity of multiple properties shall be maintained in the frontage of the lot adjacent to the road.

- C. Non-residential driveways shall match existing openings in medians, whenever possible. No cuts through the left turn reservoir of a median shall be permitted.
- D. Along roadways with a continuous, two-way, left turn lane, driveways shall not be located to require vehicles entering the driveway to cross a delineated left turn bay or storage within the limits of the delineated left turn bay.
- E. Undivided non-residential driveway approaches shall have a minimum width of twenty (20) feet and a maximum width of forty feet (40'). Divided non-residential approaches shall have a minimum width of thirty feet (30') and a maximum width of fifty-eight feet (58'). Travel lanes of divided driveways shall be a minimum of twelve feet (12') wide and shall be divided by a raised median a minimum of six feet (6') wide.
- F. Non-residential driveway approach curb radii shall be a minimum of twenty-five feet (25') on roadways with a posted speed limit of 40 mph or less and a minimum of thirty-five feet (35') on roadways with a posted speed limit greater than 40 mph. Curb radii of signalized driveway approaches shall be a minimum of thirty-five feet (35') regardless of the adjacent roadway's posted speed limit. Selection of the appropriate driveway curb radii shall consider the roadway speed limit, pedestrian activity, the existence of turn lanes, roadway geometrics, intersection signalization and other appropriate criteria.
- G. Non-residential driveway spacing shall meet the spacing requirements for driveways located along major thoroughfares and collectors, unless specifically approved by the Department of Public Works.

8.07 DRIVEWAYS ALONG MAJOR THOROUGHFARE AND COLLECTORS

- A. The following requirements, in addition to the requirements of Sections 8.04, 8.05 and 8.06, shall apply with respect to driveway approach spacing and location along major thoroughfares and collector streets. Spacing between driveways should be measured along the property line from the edge of one driveway to the closest edge of the next driveway and not from centerline to centerline.

1. The minimum required spacing between driveway approaches for driveway along collector streets and major thoroughfares is listed below:

Posted Speed (mph)	Minimum Spacing (feet)
25	150
30	230
35	300
40	350
45	400
50	450
>50	TIA required

2. Driveway approaches accessing major thoroughfares and collectors shall be aligned with opposing driveway approaches, if any, or should be offset by 200 feet (200') or more to provide adequate left turn storage capacity in advance of each driveway approach and to avoid the overlap of left turn lanes.
 3. Driveways shall be spaced at distances sufficient to ensure that conflicting movements at adjacent driveways do not overlap.
- B. Entrances to non-residential driveway approaches shall be designed so as to provide adequate sight distance required for safe travel. A sight distance analysis, sealed by a professional engineer, shall be provided on all construction plans. The sight distance analysis will show the available sight triangles with all proposed and existing improvements in place.
 - C. Turn bays shall meet the minimum requirements of the Institute of Transportation Engineers (ITE) and the American Association of State Highway and Transportation Officials (AASHTO) "A Policy on Geometric Design of Highways and Streets".
 - D. Notwithstanding any other requirements set forth herein, signalized driveway entrances shall be required of driveway approaches that are major traffic generators and shall conform to ITE and AASHTO traffic signal spacing guidelines.
 - E. Deceleration lanes for right-turns into driveways shall be required where necessary to minimize driveway/roadway conflicts.
 1. No driveway shall be permitted within the transition area of a right-turn or deceleration lane, unless otherwise approved by the City Engineer. If allowed, transition for right-turn or deceleration lane shall be extended a maximum of fifty feet (50').
 2. The applicant shall be responsible for the design, ROW adjustment of utilities, and construction costs of any auxiliary and deceleration lane required as a condition of a driveway permit.
 3. A ten-foot (10') street easement shall be provided for deceleration lanes for non-residential developments, if necessary.

4. Refer to Chapter 11 for deceleration lane design standards.

END OF CHAPTER



City of Richmond

Design Manual

Chapter 9

TRAFFIC IMPACT ANALYSIS REQUIREMENTS

CHAPTER 9

TRAFFIC IMPACT ANALYSIS REQUIREMENTS

9.01 GENERAL

- A. These standards describe the general requirements for the preparation of a Traffic Impact Analysis (TIA) for approval by the City of Richmond.
- B. The Richmond Public Works Department shall approve all required traffic impact analyses within the Richmond city limits or extraterritorial jurisdiction.
- C. A TIA is required as a part of the approval process for zoning changes; building permits applications, subdivision platting or changes of occupancy. A TIA is required at the earliest stage of development process to provide technical basis for driveway placement and other traffic improvements.
- D. Public Works Department personnel will be available for preliminary meetings to discuss a proposed traffic impact analysis with the project engineer. This preliminary meeting between the City and the engineer should be scheduled with the Department of Public Works staff prior to submittal of any documents for review. The purpose of this meeting is to discuss the project concepts and to establish the status of requirements and issues that may be pertinent to the traffic impact analysis.
- E. A TIA, when required, shall be prepared by an individual, group, firm or corporation having demonstrated professional emphasis and experience in transportation planning, engineering and in the preparation of similar analyses. The TIA document shall bear the seal and signature of a Texas Registered Professional Engineer.
- F. The submitted TIA must be approved by the Department of Public Works. Approval is valid for a period of twenty-four (24) months, provided significant changes in the development proposal or surrounding conditions have not occurred.
- G. The goal of the traffic impact analysis is that the level of service (LOS) resulting from the new development be no worse than the existing LOS. Any degradation in LOS shall be mitigated.

9.02 WHEN TRAFFIC IMPACT ANALYSES ARE REQUIRED

- A. At the discretion of the City Engineer, a TIA shall be required for any development proposal expected to generate traffic volumes that will significantly impact the capacity and/or safety of the transportation network. A TIA may also be required for a development located near a sensitive area, a high accident location or an area already suffering from congestion.
- B. Proposed developments that are forecasted to generate one or more of the following trip thresholds, based on the latest version of the Institute of Transportation Engineers Trip Generation Manual, shall be required to conduct a traffic impact analysis.
 - 1. 750 trips per average weekday (ADT)

2. 100 directional trips during the peak hour of either the traffic generator or the adjacent roadway
3. 50 directional trips during the peak hour of either the traffic generator or the adjacent roadway, if the Level of Service on the adjacent road network within one-half (½) mile of the traffic generator is below LOS C.
4. Redevelopment, rezoning, additions or changes of occupancy that are expected to increase trip generation or directional flows by 20% or greater over existing conditions.

C. The following table lists development sizes for typical uses that are assumed to meet the minimum threshold levels requiring a traffic impact analysis. A traffic impact study can be required at the discretion of the City Engineer, even if the threshold levels are not met, if based on his professional judgment the development may have an adverse impact on traffic safety due to the design, location or use of the proposed development.

LAND USE	100 PEAK HOUR TRIPS	750 DAILY TRIPS
Single Family Residential	150 dwelling units	70 dwelling units
Multi-family Residential	220 dwelling units	120 dwelling units
Condos/Townhouses	245 dwelling units	120 dwelling units
Church (GFA)	10,000 sq. ft.	7,000 sq. ft.
Shopping Center (GFA)	15,000 sq. ft.	2,700 sq. ft.
Day care Center (GFA)	7,400 sq. ft.	6,000 sq. ft.
Fast Food Restaurant (GFA)	5,000 sq. ft.	1,200 sq. ft.
Convenience Store w/gas (GFA)	1,300 sq. ft. or 5 pumps	700 sq. ft. or 5 pumps
Bank w/drive in	4,400 sq. ft.	2,800 sq. ft.
General Office	55,000 sq. ft.	45,000 sq. ft.
Medical/Dental Office	37,000 sq. ft.	26,000 sq. ft.
Light Industrial	115,000 sq. ft. or 8 ac.	70,000 sq. ft. or 11.5 ac.
Research & Development	85,000 sq. ft. or 4.5 ac.	70,000 sq. ft. or 11.5 ac.

D. At the discretion of the City Engineer, a full traffic impact analysis (TIA) may not be required if:

1. No safety or capacity problems exist in the immediate vicinity of the development.
2. A prior TIA, prepared for a site located within 1,000 feet, indicates that build-out of vacant tracts will not create capacity or safety problems on the adjacent street network.
3. The proposed development or use produces less than 50 directional trips during the peak hour of either the traffic generator or the adjacent roadway and/or;
4. The proposed development is a reuse of an existing building and the new use produces trips of the same nature that are less than 120% of the trips generated by the prior use and if no safety or capacity problems exist.

9.03 SCOPE OF REQUIRED TRAFFIC IMPACT ANALYSIS (TIA)

- A. Prior to beginning a traffic study, the engineer should contact the Department of Public Works to determine the scope of the work to be performed. The City will work with the developer and the traffic engineer to determine appropriate assumptions for the analysis. The following items should be considered in the preliminary analysis and addressed in the TIA:
1. The level of detail needed for the study.
 2. Trip generation rates to be used.
 3. If pass-by or modal split analysis is required.
 4. The need for internal circulation analysis.
 5. Reductions to trips due to internal circulation, if appropriate.
 6. List of development close to the site to be considered.
 7. Assumptions for area wide growth (Background traffic calculation methods).
 8. Consideration of phased development and transportation improvements.
 9. Identification of study area, land uses and key intersections.
 10. Identification of high accident areas.
 11. If consideration of pedestrian, bicycle or transit impacts are needed.
 12. Analysis period and the typical peak hours for the proposed land use.
 13. If a new signal is warranted the existing traffic corridor must be examined for changes that need to be made in conjunction with the new signal.
 14. A feasibility study of placing a roundabout in lieu of a traditional traffic signal is required.
 15. If modification is required of an existing traffic signal the timing and phasing must be examined. In addition, a full analysis of the corridor-wide synchronization will be required. In addition the implementation of the recommendations called for in the TIA report shall be required.
- B. Three levels of study have been identified based on the number of trips that a development is projected to generate in a 24-hour period (ADT) and during peak hour. The following table is offered as a general guideline of typical requirements. The City Engineer may have further requirements based on site-specific conditions.

Levels of Traffic Impact Study

Project Category	Criteria	Study Horizon	Study Area
I	Projected site-generated ADT of 750 OR Projected site-generated peak hour trips of 100 per hour AND No significant modification of traffic signals or roadway geometry proposed	Year of completion, assuming full build- out and occupancy	All site access points, adjacent roadways, and major intersections. All signalized intersections on each street serving the site within 1/4 mile
II	Projected site-generated ADT of 751-2000 OR Projected site-generated peak hour trips of 101-250 per hour OR Installation or modification of traffic signals or roadway geometry proposed, regardless of project size	Year of completion, assuming full build- out and occupancy AND Five years after completion	All site access points, adjacent roadways, and major intersections. All signalized and major un-signalized intersections on each street serving the site within 1/2 mile
III	Projected site-generated ADT > 2000 OR Projected site-generated peak hour trips > 250 per hour OR Installation or modification of two or more traffic signals, addition of travel lanes, or modification of interchange proposed, regardless of project size	Year of completion, assuming full build- out and occupancy AND Five years after completion	All site access points, adjacent roadways, and major intersections. All signalized and major un-signalized intersections on each street serving the site within 1 mile

- C. The TIA should incorporate all transportation and land development information that is current and available. Table 9-2 from the ITE Traffic Engineering Studies Handbook should be reviewed to determine if any additional information on background data is needed.

9.04 SUBMISSION AND REVIEW PROCEDURES

- A. A preliminary trip generation assessment of proposed development should be conducted to determine if a traffic study would be required. If the preliminary assessment indicates that a traffic study will be required, the applicants should immediately consult with Department of Public Works to verify a development's projected trip generation, and to confirm whether or not a study will be required. If a study is required, the required level can be determined at that time along with other necessary parameters.
- B. The Department of Public Works shall review the traffic impact analysis in conjunction with the other elements of the development application. If the draft study is not of the proper scope or is executed improperly, the applicant shall be notified of the deficiencies and be required to submit corrections on the same schedule that applies to the other elements of the development application. Failure to submit corrections in a timely fashion may lead to a postponement of the application.
- C. One (1) copy of the final TIA report, along with a PDF copy, including all necessary backup data are required for review and City approval. Upon receiving City approval an electronic version shall be submitted that includes all data but not limited to the following: 1) separate traffic count, 2) all Synchro traffic modeling data and 3) all relevant data files. These files are to be submitted with the final approved TIA.
- D. Any traffic study will need to be revised if the proposed land use is changed by type or size. In

addition, any traffic study may need to be revised if the study is older than 2 years and the City Engineer determines that the existing conditions have changed enough to invalidate the study results or if the initial study assumes an incorrect build out period.

9.05 FUNDING RESOURCES

- A. The (TIA) may take into account the city/state/county approved traffic improvements with dedicated funding. The City Engineer will determine what approved traffic improvements may be considered. The developer prior to the issuance of the occupancy permit shall complete any required traffic improvements, which have not been funded or otherwise completed by the government agencies.
- B. When it can be demonstrated that a development will only partially contribute to the need for additional off-site improvements, the city may require a pro-rated contribution according to the percentage of traffic added by the development.
- C. The City will verify that all traffic improvements to be provided by the developer or property owner have been completed before a Certificate of Occupancy shall be issued.

9.06 TRAFFIC IMPACT STUDIES REPORT REQUIREMENTS

- A. It is recommended that along with the requirements provided in these guidelines, the most recent version of the following resources should be referenced during the development of a traffic impact study.
 - 1. Highway Capacity Manual
 - 2. Manual of Uniform Traffic Control Devices
 - 3. Trip Generation, ITE
 - 4. Trip Generation Handbook, ITE
 - 5. Trip Generation User's Guide, ITE
 - 6. Traffic Engineering Handbook, ITE
 - 7. Manual of Transportation Engineering Studies, ITE
 - 8. SYNCHRO Traffic Modeling Software
- B. This section defines the elements that are required in a TIA. A thorough report shall address each of the items below.

1. Introduction

- a. Include a description of the site location and study area, including a location map identifying key intersections and other approved projects in the vicinity.

- b. Development Description shall include type of land use and the following information where applicable:
 - i. If residential, number and type of dwelling units
 - ii. If commercial or industrial, square footage and type of development
 - iii. Detailed site plan
 - iv. Development phasing and timing
- c. Selection of analysis period shall be based on the proposed land use and the typical peak hours. Many nearby land uses may influence peak times of a particular intersection. For example an intersection near a hospital may peak during a mid-afternoon shift change rather than the typical pm peak hour. Schools, churches, hospitals or shipping centers may impact peak periods due to their individual peaking characteristics. Care should be given to understand the surrounding land uses before deciding upon the peak hours. An investigation of the daily counts prior to collecting the peak-hour counts would allow a determination of a typical range of peak hour traffic movements on a roadway facility.

2. Existing Conditions

- a. A thorough review of available data and existing conditions at the site shall include at a minimum the following items:
- b. A site visit by the engineer of record.
- c. Study area land use
 - i. Existing land use
 - ii. Existing zoning
- d. Site access will be shown on the plan and reviewed for sufficiency of operation and impacts to the surrounding roadway system.
- e. Posted speed on all existing roads that may be significantly impacted by the development.
- f. Distances from existing streets, driveways, and/or median cuts to development access.
- g. Alignment with existing streets, driveways, and/or median cuts to development access.
- h. Intersection layout, lane usage and roadway configuration.
- i. Traffic control devices such as traffic signals or stop signs.
- j. Traffic signal timing and phasing – Offset times should be shown if any coordination with adjacent signals is being used.

- k. Right of way width(s) all existing roads that may be significantly impacted by the development.
- l. Lane width(s) for all lanes
- m. Daily and peak-hour traffic counts should be collected for use in the traffic impact study. At a minimum a 24-hour count should be taken on a typical Tuesday, Wednesday or Thursday for all roadways in the study area. However, the type of development or local conditions may require counts be taken on weekends. Peak-hour intersection turning movement counts (15 min. increment) at key intersections should also be taken. As with the daily counts, peak-hour counts may vary. Traffic counts used in a study should be less than one year old. The City reserves the right to request more counts if they are deemed necessary based on specific conditions. The existing counts should be presented in a diagram form for each intersection counted.
- n. Pedestrian facilities and volumes (If appropriate)
- o. Level of service of roadway sections and intersections - The latest edition of the Highway Capacity Manual (HCM) or approved traffic analysis software (SYNCHRO) may be used. Prior approval of alternate software may be requested from the City Engineer during the preliminary study meeting.
- p. Photographs may be used to document existing conditions of the site.

3. Projected Traffic

- a. The calculation of the project traffic shall be shown in sufficient detail so that all calculations can be verified. In addition, descriptions of the following items shall be included in the report.
- b. Site Traffic (Daily, a.m. and p.m. peak)
 - i. Trip Generation - List of trip generation rates and sources of rates used for the study. The latest edition of the Trip Generation Manual from ITE shall be used. Calculation of trip ends assuming 100% occupancy and development.
 - ii. Trip Distribution and Assignment - The gravity model or other acceptable trip distribution model can be used to estimate site trip distribution. Trip Distribution and Assignment can be accomplished either manually or with applicable computer models. A figure showing the trip distribution is required.
- c. Background Traffic (Daily, a.m. and p.m. peak) - This shall account for all approved developments in the study area as well as area growth beyond study area. Typically this is determined through analysis of historical trends in the region. This should be discussed at the preliminary study meeting. If necessary, this peak-hour data shall also be shown in a figure similar to that for the existing

traffic.

- d. Reassignment rates for pass-by and diverted trips - A procedure for calculating pass-by trips is described in Chapter 5 of the ITE Trip Generation Handbook based on different land use classifications. The table below shows values to be used for the most typical land use. Reduction for any other land use types must be thoroughly documented and approved by the City Engineer. Internal capture can be accounted for using the procedures described in Chapter 7 of the ITE Traffic Engineering Handbook.
- e. Total Traffic shall be shown combining project and background traffic and shown in figure form for each intersection.
- f. Future Traffic (if required) shall also be calculated and shown in similar figure format.

Pass-By Trip Reduction For Typical Land Uses

Land Use	Acceptable Trip Reduction
Retail > 400,000 GLA	20 %
Retail 100,000-400,000 GLA	25 %
Retail <100,000 GLA	35 %
Quality / Sit-down Restaurants	15 %
Fast-food Restaurants	35 %
Convenience/Gas Stations	40 %
Banks	15 %
Supermarket	20 %
Discount Club/Warehouse Store	20 %

4. Traffic Analysis

The following information should be included in the report describing the detailed analysis performed for this study.

- a. Projected Capacity and Level of Service (Background traffic and total traffic) for the study horizon.
 - i. Signalized intersection analysis.
 - ii. A capacity analysis using projected traffic volumes must be conducted using the latest edition of the Highway Capacity Manual (HCM).
 - iii. Traffic analysis software may be used. The latest edition of Highway Capacity Software shall be used or prior approval of alternate software may be requested from the City Engineer.

- iv. Un-signalized intersections and traffic signal warrant analysis if applicable. A capacity analysis using projected traffic volumes must be conducted using the latest edition of the Highway Capacity Manual (HCM). If signalization is warranted by the traffic signal warrants outlined in the Manual on Uniform Traffic Control Devices (MUTCD), conduct a complete warrant analysis and analyze the intersection(s) as signalized intersection(s).
 - v. Roadway network - Impacts to LOS on key mainline roadway links should be determined.
 - vi. Turning vehicle storage space needed or the adequacy of storage space for turning vehicles at study intersections should also be analyzed. This analysis should consider signal phasing and overall signal cycle length, as well as vehicle volumes. Analysis of queuing may be required.
- b. A table for each of the following information will be provided. The AM and PM peak-hour data will both be shown unless determined otherwise by the City Engineer.
- i. Existing LOS and delay.
 - ii. Background LOS and delay without development.
 - iii. Future LOS and delay with development.
- c. Site circulation and parking requirements - Driveways should be designed considering the amount and type of traffic that will be using both the driveway and the adjacent street. Adequate access for service vehicles should be reviewed by determining the size and operating characteristics of service vehicles, particularly the turning radii. In addition, driveway throat lengths should also be considered.
- d. Determine impacts to nearby neighborhoods and evaluate the potential need for any traffic calming.
- e. Accident analysis may be required at intersections that currently have a high number of accidents.
- f. Additional facilities
- i. Sidewalks
 - ii. Transit stop(s)
 - iii. School bus stops

5. Conclusions and Recommendations

The final section of the report should summarize the overall impact of the development and include the following information:

- a. Site access/circulation plan
- b. Intersection improvements addressing, at a minimum, the following:

- i. Traffic control device(s) - modify existing or need for new
 - ii. Additional lanes needed (left, right or thru)
 - iii. Acceleration and/or deceleration lanes
 - iv. Length of storage bays
 - v. A detailed drawing of any intersection improvements shall be included in the report.
 - vi. Implementation schedule
- c. Off-site improvements
 - i. Modification to existing traffic control device(s)
 - ii. Additional traffic control device(s), additional lane at major intersections, and additional roads
 - iii. Other improvements if applicable

VI. Appendix

The following appendices should be included in a bound report submitted to the public works department:

- a. Raw traffic count data
- b. Printouts of analysis results
- c. Photographs of site
- d. Additional tables or figures not included in report
- e. Professional staff qualifications and experience

9.07 TECHNICAL NOTES

Trip Generation: Average trip generation rates or regression equations for the peak hour of the adjacent street will be obtained from the current edition of the Institute of Transportation Engineer's Trip Generation Manual. Other local data may be acceptable provided it was collected using recommended methodology and can be properly document.

Peak Hour Percent: A peak hour percentage of 10 percent of the daily trips will be assumed for existing traffic unless hourly counts are available.

Peak Hour: Generally, the petitioner shall use the peak one hour period which occurs during either 7-9 A.M. or 4-6 P.M. periods or both, as agreed to by the staff and petitioner. In some cases, however, the City Engineer may require additional hours, for example, Friday nights or Saturday afternoon, to also be analyzed.

Directional Split: The directional split of the entering and exiting traffic associated with the development will be derived from the ITE Trip Generation manual unless other acceptable locally generated data is available.

Pass-by Trips: The percent of pass-by trips shall be applied to the trips generated by the proposed development and assigned to the adjacent street network. This rate does not affect the proposed project’s driveway volumes but rather reassigns existing trips to movements entering and exiting the proposed development. The following pass-by trip rates have been determined for some land uses:

Land Use	Acceptable Trip Reduction
Retail > 400,000 GLA	20 %
Retail 100,000-400,000 GLA	25 %
Retail <100,000 GLA	35 %
Quality / Sit-down Restaurants	15 %
Fast-food Restaurants	35 %
Convenience/Gas Stations	40 %
Banks	15 %
Supermarket	20 %
Discount Club/Warehouse Store	20 %

Diverted Linked Trips: A reassignment for diverted trips will generally occur outside the impacted study area; therefore, for the purpose of these traffic impact studies, diverted trips would be considered “new trips” within the study area and can be ignored in most cases. This factor, if applicable, will be decided during the preliminary meeting.

Internal Circulation Trips: Reductions for internal circulation trips are applicable for projects such as shopping centers with out-lots and represents a reduction in projected driveway trips. The internal circulation trip rate will be agreed upon during the preliminary meeting and shall not exceed 10 percent.

Trip Distribution: The directional distribution of the generated trips entering and exiting the proposed development via all access points must be justified by the relative locations of other traffic generators (e.g., employment centers, transportation terminals, etc.) and/or trip table information. These factors, or other factors agreed upon by the Department of Public Works, shall be applied to the traffic generated by the proposed development as well as the traffic generated by nearby approved projects.

Trip Assignment: The distribution factors shall be applied to the trips generated by the proposed development and nearby approved projects and assigned to the existing traffic on the road network providing access to the proposed development.

Capacity Analysis: At the identified critical intersection(s), the existing and generated traffic is to be related to the adequacy of the intersection by using the techniques described in the latest edition of the Highway Capacity Manual or utilizing SYNCHRO modeling software. The analysis should be carried out for the A.M. and/or P.M. peaks, as agreed to by the staff and applicant. It is also recommended that the operational methodology be used in the analysis of signalized intersections

Traffic Data:

- A. Traffic volume data may be available from the Department of Public Works for some locations within the City. If, however, acceptable data is not available, the petitioner is responsible for obtaining all required data.
- B. Traffic count data should be no older than one year or the city may require new counts be collected. If, in the opinion of the Department of Public Works staff, traffic volumes have significantly increased due to some change(s) in the traffic pattern, such as the completion of a development project after the count was made new counts may also be required.
- C. If turning movement data is outdated or if there are locations for which data is non-existent, data must be acquired at the applicant's expense.
- D. Intersection traffic counts conducted by the petitioner should be comprised of manual turning movement counts covering the peak A.M. and P.M. periods in order to allow for the selection of the peak hour within the next fifteen minutes (e.g., 4:00-5:00, 4:15-5:15, etc.) The inclusion of all A.M. and P.M. peak period turning movement data is requested as part of the traffic impact analysis.
- E. Ideally the traffic analysis should be performed for the design hour which represents the 30th highest hourly traffic volume on an annual basis. However, most peak hour traffic volume counts in urban areas closely approximate the 30th highest hour. Historical counts and staff knowledge of the area will be used to judge the adequacy of counts used by the applicant.
- F. If the proposed development includes plans for the installation of a new traffic control signal, the petitioner must conduct a Traffic Signal Warrant Analysis. This analysis would produce documentation that indicates the conditions at the proposed location warrant a traffic signal by meeting the recommended minimum warrants presented in the Manual for Uniform Traffic Control Devices, (MUTCD). Documentation of this analysis should be included in the appendix of the final report and should include, but not be limited to, the methodology used, daily traffic count data used in the analysis, and the resulting capacity analysis results at this location.

Adequate Accommodation of Traffic: The ability of a highway system to carry traffic is expressed in terms of volume-to-capacity (V/C) ratios and level of service at the critical locations, usually intersections. The V/C ratios clearly define the degree of saturation at an intersection. A V/C ratio of 1.0 indicates that the intersection is operating at its theoretical capacity, that is, the traffic volume demand equals the estimated number of vehicles that may pass through the intersection in a given period of time. A value of over 1.0 depicts a situation where the demand exceeds the intersection's capacity and operational problems exist, either in geometrics or signalization. As the V/C ratio approaches 0.9, breakdowns in the operational efficiency of the intersection tend to develop. When the V/C increases above 0.9, operational breakdowns also increase in frequency and may result in a high level of delay to motorists.

In considering mitigation measures, the change in V/C ratio and level of service must be taken into account as well as the actual V/C values of individual approaches and the overall intersection. If no mitigation exists or if the improvements required are beyond what could reasonably be expected from the applicant, then negotiations between the petitioner and the City will be conducted to determine the level of petitioner responsibility for improvements at the intersection.

Level-of-service for signalized intersections is defined by the Transportation Research Board's Highway Capacity Manual, in terms of delay. Generally, delay is considered a measure of driver discomfort,

frustration, lost time and fuel consumption. Delay at signalized intersections is a result of a number of factors, including the signal's cycle length, phasing, progression in relation to other signals, traffic volumes and the intersection's lane configuration and geometrics.

Traffic Impact Study Checklist

Preliminary Meeting

- Contact the City Prior to beginning the study
- Analysis needed for AM and PM Weekday
- Analysis needed for Weekend
- Analysis needed for Mid-day Weekday or school period

Existing Conditions

- Existing zoning (source cited)
- Geometric parameters of existing roads from governing body
- Existing traffic counts
- Intersection counts (eight hours if a traffic signal warrant will be conducted)
- 24-hour volume counts (Tuesday to Thursday, or possibly weekend)

Site Traffic

- Clear and concise description for trip generation purpose (source cited)
- Vicinity map
- Site plan
- Trip generation using the latest edition of ITE Trip Generation Manual
- Trip distribution (Each step of this procedure should be clearly shown in enough detail so that all calculations can be verified)
- Account for pass-by trip and internal capture reductions.

Background Traffic

- Clear and concise description for trip generation purpose (source cited)
- Vicinity maps of background sources
- Trip generation using the latest edition of ITE Trip Generation
- Trip distribution (Each step of this procedure should be clearly shown in enough detail so that all calculations can be verified)

Traffic Analysis

- Existing level of service (LOS) analysis using latest version of HCS software or other software approved by the city.
- Background LOS analysis using latest version of HCS software or other software approved by the city.
 - Capacity analysis for un-signalized intersection using latest version of HCS software or other software approved by the city.
 - Signal warrants analysis using Manual on Uniform Traffic Control Devices
 - Capacity analysis for signalized intersection using latest version of HCS software or other software approved by the city (if existing or warranted)
 - Turning vehicle storage space (queuing) analysis
- Projected LOS analysis using latest version of HCS software or other software approved by the city.
 - Capacity analysis for un-signalized intersection using latest version of HCS software or other software approved by the city.
 - Signal warrants analysis using Manual on Uniform Traffic Control Devices
 - Capacity analysis for signalized intersection using latest version of HCS software or other software approved by the city. (if existing or warranted)
 - Turning vehicle storage space (queuing) analysis
- Site circulation/parking analysis
- Safety / site distance analysis
- Discussion of additional facilities (sidewalks, bus stops, etc.)

Conclusions and Recommendations

- Recommended site modifications (include drawings)
- Recommended intersection improvements (include drawings, timing methods, etc.)
- Recommended off-site improvements (include drawings)

Documentation

- Electronic version of raw traffic count data
- Electronic version of Synchro traffic modeling output files and other traffic software data used for analysis
- ITE Trip Generation summary
- Capacity analysis printouts and data file
- MUTCD Traffic Signal Warrant worksheets

Report

- Signed and stamped by registered Professional Engineer in the State of Texas

NOTE: This checklist is provided for convenience only and represents only a partial list of the requirements for any given study.

END OF CHAPTER



City of Richmond

Design Manual

Chapter 10

TRAFFIC SIGNAL REQUIREMENTS

CHAPTER 10

TRAFFIC SIGNAL REQUIREMENTS

10.01 GENERAL

- A. These standards describe the general requirements for the design and construction or the modification of a Traffic Signal for within the City of Richmond. Traffic roundabouts are required to be installed in lieu of a traffic signal whenever feasible. Design for roundabouts must meet current industry standards and individually approved by the city.
- B. The Richmond Public Works Department shall approve all required traffic signals within the Richmond city limits or extraterritorial jurisdiction. Improvements within Texas Department of Transportation (TxDOT) Right of Way must obtain all permits and any necessary approval from TxDOT prior to city approval.
- C. All traffic signal work shall utilize the latest design guideline details required by the State of Texas. Traffic signal design shall incorporate energy saving measures and modular design for expansion to the maximum extent practical.
- D. This guideline serves as a reference standard, and does not supersede any design standards set forth by the Texas Manual on Uniform Traffic Control Devices (MUTCD), Texas Accessibility Standards (TAS) of the Architectural Barriers Act, or any other federal, state, or local law or regulation. The intent is to provide a standard reference to promote the highest quality and latest engineering practices available.
- E. Traffic signals shall be prepared by an individual, group, firm or corporation having demonstrated professional emphasis and experience in transportation planning, engineering and in the preparation of similar analyses. The construction documents shall bear the seal and signature of a Texas Registered Professional Engineer.
- F. A paper and an electronic copy of the project as-built, in PDF and dxf or.dwg format, and shapefile (applicable with street alignment changes) are required prior to project acceptance into the one-year maintenance period for all traffic signals constructed within the city limits and extra-territorial jurisdiction of Richmond.

10.02 TRAFFIC SIGNAL SYSTEM DESIGN GUIDELINES

- A. Prior to beginning design, the engineer shall contact City of Richmond to determine special design criteria, which may include pole types, interconnection with existing signals, detection, etc.
- B. All new traffic signals shall be decorative or ornamental mast arm signals with video detection, utilizing a minimum of one camera per approach, and interconnected with the City of Richmond Traffic Management Center. All traffic signals that are subject to modification or reconstruction to the degree that the modification or reconstruction is greater than 50% of the value of the traffic

signal poles and equipment shall be reconstructed as mast arm signals with video detection and signal interconnection. Span-wire traffic signals are only allowed with specific approval of the Department of Public Works.

- C. All vehicle and pedestrian signal heads shall be Light Emitting Diode (Led).
- D. Pedestrian Signals shall be countdown type.
- E. Battery backup shall be provided for all signals in separate cabinets.
- F. All traffic signal drawings shall be designed in accordance with the latest City of Richmond design standards and specifications, Texas Department of Transportation's (TxDOT) latest specifications and standard drawings, including the Houston district standards.
- G. All drawings shall be designed in accordance with the latest Texas Manual on Uniform Traffic Control Devices and acceptable engineering practices to ensure a safe and efficient operation. All traffic signal drawings shall be designed to meet the latest state-of-the-art operational and functional features for traffic signal systems required by the City of Richmond. Refer to the design check list attached to the end of this chapter for minimum requirements.
- H. Any drawing that cannot provide all the required information or reaches the capacity of one sheet is subject to additional sheets. Every drawing shall best represent the condition of the existing and/or proposed work. The drawings shall follow all construction design phases. All drawings shall conform to the next phase of construction and provide a consistent design.
- I. All design criteria shall be determined by the Department of Public Works.
- J. Line of sight or connectivity survey is required to be performed by design engineer to determine the height or location of the antennae to high-site.
- K. For City funded projects, typical project milestone design reviews are for 30%, 60%, 90% and 100% of the signal system design. The following is a list of review requirements that should be included at each milestone stage.
 - 1. The red-lined drawings and a written response of review comments from the latest review should always be included with the next submittal. City of Richmond reserves the right to alter the list in a manner that will best benefit the project.
 - 2. The in-progress (30%) design stage review shall consist of a field meeting at the project site(s) with the consultant and the City of Richmond Project Manager or appointed designee. The review requirements are a working drawing showing, as a minimum, the following:
 - a. Right-of-way.
 - b. Base line/Center line.
 - c. All above ground and underground utilities. Underground utilities shall be located as accurately as possible.
 - d. Existing roadway geometric layout.
 - e. If making geometric improvements, show proposed geometric improvements and signal design based on those improvements.
 - f. Existing sidewalks and/or driveways.

- g. Proposed wheelchair ramps, pads, and sidewalks, if required.
 - h. Proposed crosswalks, if required.
 - i. Proposed service outlet location.
 - j. Proposed controller location.
 - k. Proposed signal pole locations.
 - l. Proposed pedestrian signal pole locations, if required.
3. The in-progress (60%) the review requirements are a working drawing showing, as a minimum, the following:
- a. Proposed VIVIDS camera(s) and detection zone(s) placements.
 - b. Proposed ground box locations.
 - c. Proposed signal head locations.
 - d. All proposed overhead signing.
 - e. Proposed advance warning signs and flashers, if required.
 - f. Proposed conduit, including bore locations.
 - g. Proposed stop line locations.
 - h. For projects with road widening, construction phasing for traffic control should be included for a discussion in the field meeting.
 - i. Any construction easements or right-of-entry that may be needed.
 - j. Provide documentation to City of Richmond of posted speed and 85th percentile speed, if known.
 - k. For signal interconnect drawings, prepare pole attachment drawings in accordance with pole owner's requirements, if required.
 - l. At this stage, the proper power company should be contacted to request a Service Outlet and Data Statement for each intersection.
 - m. Proposed communication line routing layout to the Traffic Management Center.
4. The 90% Design stage review shall consist of one (1) full set of construction drawings and one (1) set of bid sheets including detailed bid items with quantities, and the respective City of Richmond specification designations. An electronic PDF copy of all submittals is required.

10.03 CONSTRUCTION PLAN REQUIREMENTS

- A. Unless otherwise specified, all drawings are to be 11" x 17" in size. The basic set of signal system construction drawings shall include, but is not limited to the following categories:
- 1. Title Sheet and/or Index of Sheets
 - 2. Utility notes
 - 3. Basis of estimate
 - 4. Condition Layout
 - 5. Paving Layout (when applicable)
 - 6. Pavement Marking and Signing Layout
 - 7. Plan Layout
 - 8. Legend for Plan Layout
 - 9. Signal Elevations (when applicable)
 - 10. Anchor Bolt Details (when applicable)
 - 11. Signal Connectivity to Traffic Management Center Sheet (when applicable)
 - 12. Pedestrian Walkway Details

13. Notes for Plan Layout
14. Standard Detail Sheets (all required and latest) Note: All detail sheets shall be signed and sealed.

B. This section defines the minimum elements that are required on the construction sheets.

1. Title Sheet

- a. Include intersection(s) and street name(s), Engineer, City of Richmond Logo, etc.
- b. Date when plans are completed
- c. Vicinity map/key map location
- d. Project title including project scope and proper road names
- e. Funding for construction.
- f. Site map with north arrow.
- g. Signature block, including a block for private utility sign-offs.

2. Index Sheet

3. Richmond Construction Notes

4. TxDOT specification note, barricade note, etc. when applicable.

5. Private Utility Notes (Utility notes for all known utilities.)

6. Project-specific traffic signal notes.

7. Basis of Estimate or Summary of Traffic Signal Quantities Sheet

- a. This sheet includes all wires/cables, conduits, ground boxes, span wires, etc. providing quantities.
- b. Detailed estimated quantities per location or per specific system.
- c. Provide all detailed items with TxDOT reference item and numbers.
- d. Bid items will be discussed under bid documents.
- e. Identify materials to be furnished by City of Richmond or others (when applicable).
- f. Quantities are for estimate purposes only.

8. Existing Conditions Layout

- a. Show all existing signing, (including speed limits, all approaches), joints in pavement, type of pavement, condition of pavement (for loops if applicable), overhead power lines, etc.
- b. Show scale
- c. Existing pavement markings and signing
- d. Existing geometrics.
- e. Existing utility locations.
- f. Any existing signal equipment.
- g. North arrow up or to the right.
- h. Right-of-way and easements.

9. Paving Plan (when applicable)

- a. Provide a proposed design showing required wheelchair ramps/landings to access pedestrian push buttons. These paving improvements must comply with the current Texas Accessibility Standards (TAS) of the Architectural Barriers Act.
- b. Provide applicable construction notes and/or paving details.
- c. Provide various notes to contractor.
- d. Provide ramp/landing dimensions as required.

10. Proposed Traffic Signal Layout Sheet A

- a. This base shall show all proposed paving improvements, signing and striping as existing.
- b. Westbound left turn is signal head 1 and continues clockwise.
- c. Northwest corner pedestrian signal for westbound is P1 and continues clockwise.
- d. Provide separate pole (unless specified by City of Richmond) for service meter with service enclosure and photo electric-cell.
- e. Locate controller/cabinet nearest power service.
- f. Locate controller/cabinet to not restrict sight distance for right turns on red.
- g. Locate wireless antenna per results of spectrum analysis survey.
- h. LED Luminaires are required on all ornamental traffic signal poles. Ornamental lamps are required.
- i. Video detection (VIVDS) typically uses a minimum of one camera per approach. VIVDS are required for all new installations and at existing signalized intersection requiring modernization of 50% or more of value and equipment (refer to 10.02B).
- j. Multiple pulse loop detectors (6'x6' one per lane) are required on all streets when video detection is not applicable. Loop detectors will be utilized only at existing signalized intersections requiring modernization, where modernization upgrades compose less than 50% of equipment cost (refer to 10.02 B).
- k. VIVIDS detection zones and/or loop detector placement is as follows:
 - All approach lanes will provide a 6'x20' loop front of loop located 5' in front of center of stop bar)
 - Left turn lanes provide a second 6'x20' presence loop with a 6' gap behind the front loop
 - One (1) loop per lane will be wired and labeled as a "counter" loop, and must be individually connected in the cabinet for use in data collection.
 - Loop sizes and locations are subject to change due to pavement joints, broken pavement, manholes, etc.
 - No loop shall be cut through pavement joints.
 - Loops are identified by phase
 - VIVDS detection zone locations to be approved by the engineer in the field

Distance From Back Of Stop Bar To Back Of Loop (Loop distance in feet)

<u>MPH</u>	<u>1st Detector</u> <u>Stop Bar</u>	<u>2nd Detector</u> <u>6' X 6'</u>	<u>3rd Detector</u> <u>6' X 6'</u>	<u>4th Detector</u> <u>6' X 6'</u>
------------	---	--	--	--

35	6' X 20'	80	100	n/a
40	6' X 20'	55	110	180
45	6' X 20'	210	330	n/a
50	6' X 20'	220	350	n/a
55	6' X 20'	225	325	415
60	6' X 20'	275	375	475
65	6' X 20'	320	430	540
70	6' X 20'	350	475	600

11. Wiring

- a. All wiring is stranded, except for #6 solid bond bare wire
- b. One (1) 2/C #12 for push buttons and one (1) 4/C #12 for pedestrian signals per phase
- c. Luminaire cables, two (2) #8 XHHW, shall by-pass the controller/cabinet and go directly to the service enclosure
- d. One (1) 7/C #12 for vehicular signals, generally one (1) 7/C #12 for two 3-section heads and one (1) 7/C #12 for a left turn signal
- e. No sign light or base light for left turn signals
- f. Three (3) 1/C #4 with one (1) #6 bare copper wire in a 2" PVC conduit between the controller/cabinet and service enclosure
- g. Provide one (1) #6 bare copper wire in all conduits other than #14 XHHW stranded wire cable for loops
- h. Typical video detection cables consist of one (1) 3/C #16 cable and one (1) RG59 coax cable per camera, unless specified differently by the manufacturer
- i. One (1) 3/C opticom cable with shield per opticom detector
- j. Any other cable(s) shall conform to the manufacturers recommended design

12. Conduit

- a. All work shall conform to NEC codes
- b. All conduits shall be PVC except where there are risers, 45 degree or more bends and exposed or above ground conduit
- c. Typically 1" conduit for loops (between ground box and edge of pavement), 2" conduit for loop home runs (2/C #14). Size all conduits by calculating the maximum fill as per NEC code.
- d. Proposed conduits shall be bored and jacked under paved areas and shall be identified on layout(s)
- e. At each pole provide a 3" (minimum) conduit from pole foundation to ground box for future use
- f. Provide a distance of 5 feet from ground box to any pole for future wheelchair ramps
- g. Provide long sweep 90's for conduit for fiber optic cable

13. Signal Head Mounting

- a. Span Wire: Two (2) brackets for each 4-section and larger traffic signal heads
- b. Mast Arm: One (1) Astro brackets for each 4-section and larger traffic signal heads
- c. Back plates are required on all signal heads

14. Legend and Notes

- a. Provide this note: "Contractor shall expose utilities as needed to install pole foundations.
- b. Right-of-way and easements.
- c. Roadway geometrics.
- d. Utilities.
- e. Advance signal signing and/or flashers, if required.
- f. Loop design (call out size, quantity and distance from stop bar).
- g. Poles (meter, signal and pedestrian signal) and controller/cabinet-l locations.
- h. Signal head locations.
- i. Luminaires.
- j. Conduit runs and bores.
- k. Ground boxes.
- l. Stop bars.
- m. Crosswalks.
- n. Wheelchair ramps.
- o. Elevation callouts.
- p. Utility contact note.
- q. Any other signal equipment.
- r. North arrow up or to the right.
- s. Scale.

15. Proposed Traffic Signal Layout Sheet B

- a. Provide signal head schedule illustrating all vehicle signal heads and signs attached to signal heads.
- b. Provide sign schedule and dimensions showing all overhead signs.
- c. Pole schedule and notes.
- d. Electrical schedule and notes.
- e. Provide various notes to contractor and any additional notes or details.
- f. Overhead street name signs shall conform to the City of Richmond sign detail (size and color).
- g. Detection phasing

16. Signal Elevations (for strain pole type design only)

- a. Poles, signals and pedestrian signals numbered and details.
- b. Show video detection or any other directional devices in their proper place.
- c. Elevation views for all approaches and proper callout.
- d. Electrical schedule callouts and guy wire details.
- e. Show all conduits in foundations and call out what conduit runs serve.

- f. Add note: “For Legend and Callouts See Traffic Signal Layout Sheet”.
 - i. Luminary locations.
 - ii. Centerline of street.
 - iii. Special notes or details.

17. Anchor Bolt Orientation Details (for strain pole type design only)

- a. Show all items located on span wires.
- b. Show angle between span wires and angle of resultant force for each pole.
- c. Show anchor bolt orientation for each pole, two (2) bolts compression and two (2) bolts tension.
- d. Provide same scale and orientation as Plan Layout.
 - i. Street names
 - ii. North arrow up or to the right.
 - iii. Special notes or details.

18. Signal Interconnect Sheet

- a. Show all existing/proposed intersections involved.
- b. Design notes for connections.
- c. Electrical chart for interconnect cable(s).
- d. Add Note: “Refer to Intersection Layouts and Legends for Plan Layout Sheets for Additional Information Regarding Interconnect Cable”.
- e. All required details and elevation details.
- f. Intersection locations for interconnect system.
- g. North arrow up or to the right.
- h. Scale
- i. No splices will be allowed while installing and/or modifying interconnect cables. Damaged cable will be replaced from controller to controller.

19. Pavement Marking and Signing Layout

- A. This base shall show all proposed paving improvements as existing and include all existing signing and striping.
- B. Provide proposed design of all applicable pavement markings.
- C. Signal Ahead” signs are typically provided on approaches per MUTCD requirements.
- D. Show on drawings:
 - i. Right-of-way and easements.
 - ii. Roadway geometrics.
 - iii. Utilities.
 - iv. Existing Pavement Markings and Sign details (complete).
 - v. Proposed Pavement Markings and Sign details (complete, including removal of existing pavement markings and signing as needed).
 - vi. Construction signing.
 - vii. Stop bars.
 - viii. Crosswalks, if required.
 - ix. Wheelchair ramps, if required.
 - x. North arrow up or to the right.

- xi. Legend.
- xii. Scale.
- xiii. Special notes.

20. Pedestrian Walkway Details

- a. Current pedestrian walkway details with the following plan layout details:
- b. Existing intersection condition.
- c. Proposed pole locations and identified.
- d. Proposed pedestrian walkway design layout.

21. Notes for Plan Layout

- a. Callouts for all signals and sign types.
- b. Callouts for all signs and all sign types.
- ~~e.~~ Notes to reference specific sheet(s).
- d. Any note pertaining to signal design shall be included.
- e. Special VIVDS specification if required.
- f. Special equipment descriptions.
- g. Maintenance of existing traffic signals and operation parameters.

22. Standard Detail Sheets

- a. Any details pertaining to the proposed signal design shall be included.
- b. The details shall be the latest available from the City of Richmond and TxDOT.
- c. Any necessary quantities, i.e. pole and foundation details, shall be filled out.
- d. All detail sheets to be sealed.

23. Timings

- a. All signalized intersections shall be provided with initial signal timings.
- b. New signalized intersections that will be constructed within an existing system shall obtain prior approval from the Director of Public Works in order to match cycle lengths and time of day plans, not only for the proposed signal, but corridor wide. Timing plans shall include splits and offsets.
- c. All timing plans will be submitted to the City of Richmond for approval prior to being implemented.

10.04 APPROVED PRODUCTS

- A. All equipment and materials utilized on traffic signals within the City of Richmond shall conform to the latest Approved Products list and shall be subject to the approval of the Department of Public Works.

10.05 SIGNAL ACTIVATION

- A. Once the signal and intersection are constructed, approved and prior to activation and final acceptance, the traffic control change shall be notified to the public via sign boards in each direction. The notification period shall be for a seven (7) day period. The City shall approve the notification message and the location and plan for the traffic control change signage.

END OF CHAPTER



City of Richmond

Design Manual

Chapter 11

ROADWAYS, SIDEWALKS & TRANSPORTATION DESIGN REQUIREMENTS

CHAPTER 11

ROADWAYS, SIDEWALKS & TRANSPORTATION DESIGN REQUIREMENTS

11.01 GENERAL

- A. These standards describe roadway, sidewalk, trail and other transportation requirements required by the City of Richmond.
- B. The Richmond Public Works Department shall approve construction plans for roadway, sidewalk and other transportation public improvements within the Richmond city limits or extraterritorial jurisdiction. All construction shall conform to the City of Richmond Standard Construction Details.
- C. Construction plans for private improvements, within public right-of-ways and public easements that connect to or affect the public infrastructure shall be approved by the City of Richmond subject to the requirements of this manual and are subject to review and approval using the process defined in this manual.
- D. Street design should conform to all applicable planning tools, such as the City of Richmond Unified Development Code, the Richmond Major Thoroughfare Plan, the Richmond bike/ped and parks/trail master plans, the Texas Manual on Uniform Traffic Control Devices, the AASHTO Policy on Geometric Design of Highways and Streets, approved master plans, etc. Other considerations for design should include street function, street capacity, service levels, traffic safety, driver expectancy, pedestrian safety, and utility locations. These additional considerations may effect the minimum requirements set forth herein. Refer to the City of Richmond Major Thoroughfare Plan.

11.02 GENERAL ROADWAY DESIGN

- A. **Public Roadways** - The standard for public roadways within the City of Richmond city limits and extra-territorial jurisdiction are concrete, served by underground storm sewers. Asphalt streets with open ditches are limited to 2-lane, local access roadways located in residential zoning classification R. Asphalt streets shall be constructed in accordance with the City of Richmond Standard Construction Details.
- B. **Roadway Classifications** - The City of Richmond recognizes four basic classifications of public roadways that include major thoroughfares, major collectors, minor collectors and local streets. Each class provides a certain degree of continuity, capacity, and accessibility to adjacent land uses. While differentiated by function, there is also a variance in geometric design. Table 11.1 summarizes the general design criteria of roadways within Richmond. The typical cross-sections are depicted in Figures 11.1 and 11.2.
- C. **Roadway Geometrics** - Geometrics of city streets may be defined as the geometry of the pavement and curb areas that govern the movement of traffic within the confines of the rights-of-way (ROW). Included in the geometrics are pavement width, degree of curvature, width of traffic lanes, median nose radii, curb radii at street intersections, cross fall, crown height, pavement

thickness and geometric shapes of islands separating traffic movements and other features.

- D. **Design Speed** - The design speed is a primary factor in the horizontal and vertical alignment of roadways. Design features such as curvature, super-elevation, turning movement radii and sight distance affects roadway lane width, pavement width, pavement cross-slope, pavement crown and clearances. Designs speeds above those shown in Table 11.1 may be required if the nature of the roadway justifies a higher design speed. Refer to Table 11.1.
- E. **Grades** - Roadway grades shall be a minimum of three-tenths percent (0.3%) in order to insure proper flow of surface drainage toward inlets and a maximum of six percent (6%). Steeper grades may be permitted on local residential streets and where required by topographical features, as approved by the City Engineer.
- F. **Roadway Centerline** - Roadways shall be placed in the center of the ROW, but may be shifted slightly, with prior City approval, to avoid groupings of trees. The centerline of curves shall be tangent to the centerline of street at each end of curve.
- G. **Cross Slope/Crown Height** – Thoroughfares shall have a minimum cross slope of one-quarter inch per foot and a maximum cross slope of three-eighths inch per foot. Major and minor collectors and local streets shall have six-inch (6”) crowns.
- H. **Pavement Strength & Thickness** - All concrete pavement and curbs shall be a minimum 3,500-psi and shall meet the structural requirements of Section 11.12 & 13 and Table 11.1.
- I. **Sight Distance** - All intersections on major thoroughfares and major collectors and intersections of other streets with adjacent community fencing, monument signs or hardscaping, horizontal curves and vertical curves shall be evaluated for adequate sight distances in accordance with AASHTO guidelines. Sight distance triangles shall be shown on the plan view of construction plans.
- J. **Channelization** - Channelization shall conform to American Association of State Highway and Transportation Officials "A Policy on Geometric Design of Highways and Streets", latest edition.
- K. **Private Streets** – Private streets are streets that are not owned by the City of Richmond, the State of Texas or the County and are not dedicated for public use. All private streets shall be constructed to the same standards as public streets.
- L. **Rural Estate Subdivisions** – Rural estate subdivisions are subdivisions that typically do not have amenities such as sidewalks, streetlights and enclosed storm sewers. Paving construction and intersection layout and geometrics shall conform to the requirements of this manual and the City of Richmond Standard Construction Detail.
- M. Requirements for Thoroughfares.
 - 1. The full right-of-way for major thoroughfares adjacent to planned developments shall be dedicated at the time of platting of the development.
 - 2. When the full section of a thoroughfare is located within the city limits and is dedicated on a final plat, the esplanade and all lanes of the thoroughfare shall be constructed at the time of development of the adjacent subdivision.
 - 3. If approved by the City Engineer, one-half of the major thoroughfare, including travel

lanes, left-turn lanes and the esplanade to the centerline of the right-of-way shall be constructed at the time of initial construction of the adjacent development. The remainder of the thoroughfare shall be constructed at the time the property adjacent to the unconstructed half is developed.

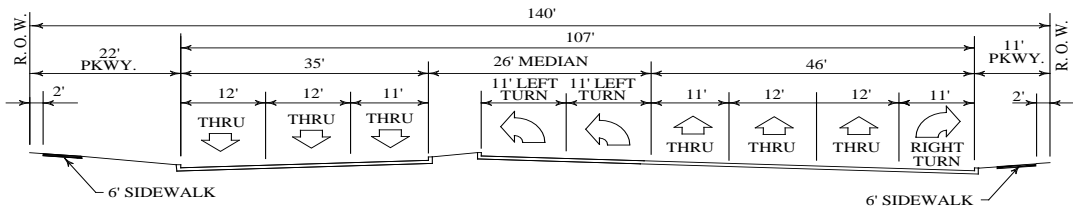
4. Permanent barricades, conforming to the requirements of the Texas Manual of Uniform Traffic Control Devices, shall be constructed at the termination of lanes on partially constructed thoroughfares. The barricades shall include a sign reading FUTURE ROADWAY EXTENSION mounted on a breakaway pole and located one foot behind the barricade, with the bottom of the sign one foot above the top of the barricade.
- N. Standard City barricades shall be placed at the end of dead-end streets not terminating in a cul-de-sac.
- O. At a T-intersection with a street that has not been improved to its ultimate width, the concrete pavement of the intersecting street shall be stopped either at the right-of-way line or the end of the curb return, whichever would require less concrete removal at a future date.
- P. For roadway turnouts placed at an existing cross street intersection, the turnout should be designed to fit the ultimate pavement width of the intersecting cross street and then transitioned to the existing roadway.
- Q. Residential driveways shall not access major thoroughfares or collector streets without written approval from the Director of Public Works. Subdivision layouts shall be designed to avoid homes requiring collector street access.
- R. Table 11.1 and Figure 11.1 are intended to represent typical situations and conditions. Typical cross-sections may be deviated from with approval of the Director of Public Works.
- S. Minimum allowable roadway tapers shall be as shown in Figure 11.20.

TABLE 11.1: City of Richmond Roadway Requirements

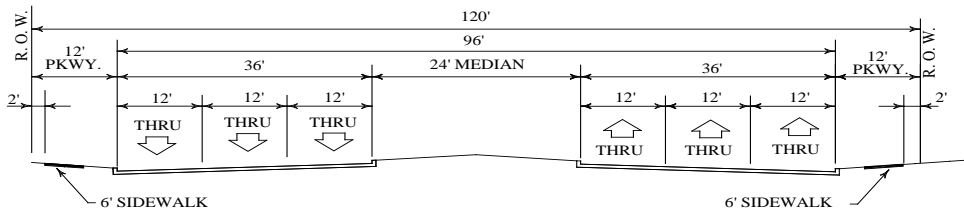
<u>Criteria</u>	<u>Roadway Class</u>				
	<u>6 lane divided Major Thoroughfare</u>	<u>4 lane divided Major Thoroughfare</u>	<u>Major Collector</u>	<u>Minor Collector</u>	<u>Local</u>
Right-of-Way (ROW)	120' ⁽⁴⁾	100' ⁽⁵⁾	70' ⁽⁶⁾	60'	60'
Typical Pavement Width ⁽²⁾ (back to back)	3 @ 37'	2 @ 25'	41'	37'	28'
Traffic Lanes	6	4	2	2	2
Left Turn-lane Width	2 @ 11'	1 @ 11'	1 @ 11'	--	--
Right Turn-lane Width	11'	11'	11'	--	--
Min. Median Width	24'	24'	--	--	--
Minimum Lane Width	12'	12'	≥ 12'	≥ 12'	≥ 11'
Minimum Pavement Thickness ⁽⁷⁾	8"	8"	7"	6"	6"
Design Speed (MPH)	55	50	40 - 45	35 - 45	30
Minimum Grade	0.3%	0.3%	0.3%	0.3%	0.3%
Maximum Grade	6%	6%	6%	6%	6%
Min. Horizontal Radii ⁽¹⁾	2,000'	2,000'	900'	667'	300'
Min. Tangent Between Curves	100'	100'	100'	100'	50'
Vertical Clearance	16'	16'	16'	16'	16'
Min. Length of Crest Curve	See Table 11.3				
Min. Length of Sag Curve	See Table 11.4				
Min. Stopping Sight Distance	525'	475'	325' – 400'	250' – 400'	200'
Bike Lane	8' min	8' min	6' min	5' min	5' min
Parking	None	None	None	Permitted	Permitted
Typical Volume Range (VPD)	30,000 - 45,000	15,000 – 30,000	5,000 - 15,000	-	-

- (1) Absolute minimum based on 0% super-elevation.
- (2) Typical mid-block pavement width
- (3) May be reduced to three hundred feet (300') radius at mid-block locations or in cul-de-sacs less than 2,000 feet long, provided that it is shown that the general public safety is not compromised. A curve, with a radius less than four hundred fifty feet (450'), must be a minimum of three hundred feet (300') from a street or alley intersection.
- (4) 140' ROW at intersections with another 4 or 6 lane major thoroughfare.
- (5) 120' ROW at intersections with another 4 lane major thoroughfare or a major collector.
- (6) 90' ROW at intersections with a 4 lane major thoroughfare or another major collector.
- (7) The pavement thickness represents the minimum requirements; additional thickness may be required based on the anticipated traffic and geotechnical soils report recommendations. Seven inch (7") pavement with #4 bars on eighteen inch (18") centers may be allowed on major thoroughfares with written approval of the City Engineer if it is supported by a geotechnical evaluation.
- (8) A minimum of 50' radius turn is allowed on local streets with a knuckle design and in accordance with the Richmond Standard Details.

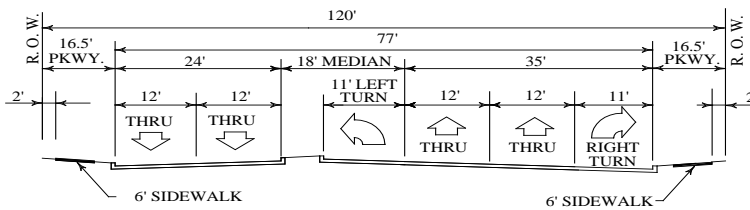
6-Lane Major Thoroughfare (Intersection)



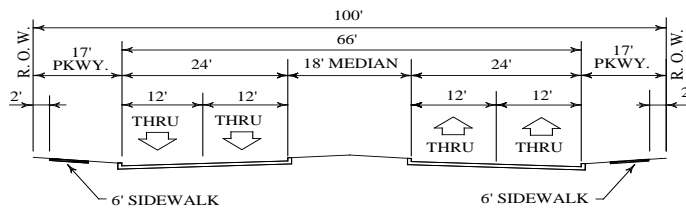
6-Lane Major Thoroughfare (Midblock)



4-Lane Major Thoroughfare (Intersection)

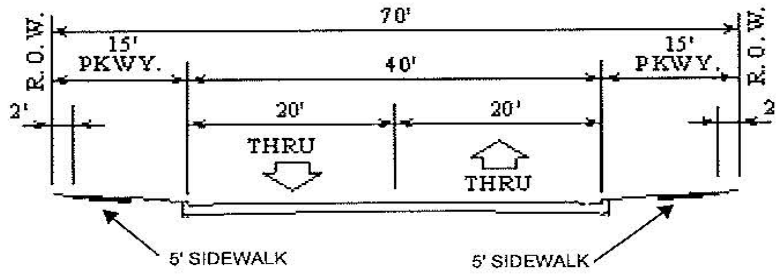


4-Lane Major Thoroughfare (Midblock)

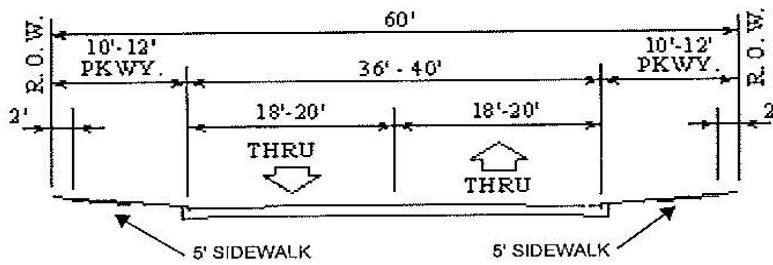


**FIGURE 11.1: Cross Sections for Major Thoroughfares
(All dimensions are face-to-face)**

Major Collector (May be divided or undivided)



Minor Collector



Local

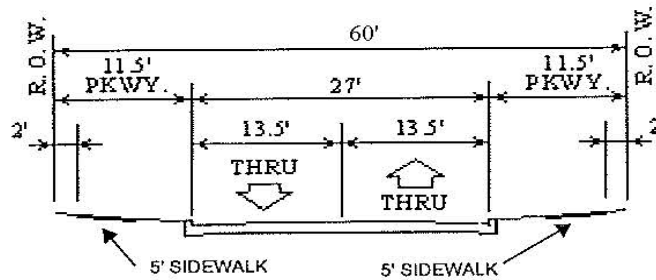


FIGURE 11.2: Midblock Cross Sections for Collector and Local Streets
(All dimensions are face-to-face)

11.03. HORIZONTAL CURVATURE

- A. Horizontal curvature is defined as the centerline radius of the street right-of-way.
- B. Minimum Horizontal Design Radius:
The minimum centerline radius is a function of design speed, super-elevation and vehicle side friction. Side friction is the force that keeps a vehicle from sliding off of the roadway. The minimum acceptable horizontal centerline radius is calculated using the following equation:

Where:
R = centerline radius (ft); V = vehicle design speed (MPH); e = rate of roadway super-elevation, (ft/ft); f = side friction factor.
- C. Major thoroughfare, collector and local street horizontal curves shall be designed without super-elevation unless approved by the City Engineer.
- D. The minimum acceptable horizontal, with super-elevation, radius is shown in Table 11.2. The maximum length of a horizontal curve on collector or local roadways shall not exceed 1.6 times the centerline radius for a radius of two hundred feet (200') or greater.

TABLE 11.2: Minimum Horizontal Centerline Radius

<u>Design Speed</u> <u>V (MPH)</u>	<u>f</u>	<u>e(ft/ft)</u>	<u>R (ft)</u> <u>(Rounded for Design)</u>
30	--	--	300
35	0.180	-0.02	454
40	0.160	-0.02	667
45	0.150	-0.02	900
50	0.140	-0.02	2,000
55	0.140	-0.02	2,000

(1) May be reduced to three hundred feet (300') radius at mid-block locations provided that it is shown that the general public safety is not compromised. A curve, with a radius less than four hundred fifty feet (450'), must be a minimum of three hundred feet (300') from a street or alley intersection.

- E. Major thoroughfares with a centerline radius of the right-of-way less than two thousand feet (2,000') require specific approval by the City Engineer and shall be designed considering recommendations for super-elevation in accordance with the American Association of State Highway and Transportation Officials, "A Policy on Geometric Design of Highways and Streets", latest edition. Signage and design speed shall be considered for all curved thoroughfares. A maximum rate of super-elevation should be 0.02 for urban conditions.
- F. The minimum curvature for a local street less than two thousand feet (2,000') long may be reduced from four hundred fifty feet (450') to three hundred feet (300') at mid-block locations or in cul-de-sacs less than 2,000 feet long, provided that it is shown that the general public safety is not compromised. A curve, with a radius less than four hundred fifty feet (450'), must be a minimum of three hundred feet (300') from a street or alley intersection and shall be signed with

an advisory speed limit and appropriate warning signs.

- G. The minimum curvature for a local street two thousand feet (2,000') long or longer shall be four hundred and fifty feet (450'). Lengths shall be measured along the centerline of the road right-of-way between the centerline of the collector or thoroughfare pavement, the center of the right angle intersection, and/or the center of the cul-de-sac.
- H. Tangent length is defined as the distance between the point of tangency and the point of curvature of two adjacent curves along the centerline of the street right-of-way. The minimum tangent length between reverse curves shall be one hundred feet (100'), except along local streets.
- I. Horizontal curves, and street alignment in general, shall be evaluated for adequate clearances from obstructions. Such obstructions could include retaining walls, abutments or bridge columns, signposts, large trees, or head walls. Appropriate measures shall be taken to eliminate and/or mitigate hazards posed by obstructions.
- J. A minimum of 50' radius turn is allowed on local streets with a knuckle design and in accordance with the Richmond Standard Details.

11.04 VERTICAL CURVATURE

- A. Vertical curves shall be designed when algebraic difference in grades exceeds one and two tenths percent (1.2%). Elevations shall be shown on the construction plans at ten-foot (10') intervals through vertical curves. The gradient for tangents to vertical curves at railroad crossings shall be a maximum of three and one-half percent (3.5%). All crest vertical curves shall be determined by sight distance requirements for the design speed. The minimum design speed on any vertical curve shall be based on the street classification.

- B. Minimum Vertical Alignment:

Vertical curves are utilized in roadway design to affect gradual change between tangent grades and will result in design that is safe, comfortable in operation, pleasing in appearance and adequate for drainage. Vertical curve alignment shall also provide Stopping Sight Distance (SSD) in all cases. SSD is a function of design speed, perception-reaction time, grade, and dynamic friction. The perception-reaction time is assumed to be 2.5 seconds as stated by American Association of Highway and Transportation Officials (AASHTO). The dynamic friction is the force that resists movement of the vehicle while the tires are in a locked position. The equation for SSD appears below:

Where:

SSD = Stopping Sight Distance (ft); P = perception Reaction Time (2.5 sec.); V = vehicle design speed (MPH); f = coefficient of friction between tires and roadway; g = percent grade divided by 100

- C. To determine the minimum acceptable length of Crest and Sag curves shown in Tables 11.3 and 11.4, it is assumed that $g=0$ in the SSD calculation. Tables 11.3 and 11.4 also show values of K. K is defined as the rate of vertical curvature and is equivalent to the horizontal distance in feet required to make a one percent (1%) change in grade. The values of A are equivalent to the algebraic difference in grade between the two grades that are being joined together by the vertical curve.

TABLE 11.3: Minimum Acceptable Crest Curve Given Speed and Difference in Grade of Road

<u>Design Speed, V (MPH)</u>	<u>SSD (ft)</u>	<u>K</u>	<u>Length of Vertical Curve (L=KA)</u>									
			<u>A=1.2⁽¹⁾</u>	<u>A=2</u>	<u>A=3</u>	<u>A=4</u>	<u>A=5</u>	<u>A=6</u>	<u>A=7</u>	<u>A=8</u>	<u>A=9</u>	<u>A=10</u>
25	155	12	--	24	36	48	60	72	84	96	108	120
30	200	19	--	38	57	76	95	114	133	152	171	190
35	250	29	--	58	87	116	145	174	203	232	261	290
40	305	44	50	88	132	176	220	264	308	352	396	440
45	360	61	50	122	183	244	305	366	427	488	549	610
50	425	84	50	168	252	336	420	504	588	672	756	840

(1) Speeds less than forty miles per hour (40MPH), no vertical curve is necessary. Speeds greater than forty miles per hour (40MPH), use length of fifty feet (50').

TABLE 11.4: Minimum Acceptable Sag Curve Given Speed and Difference in Grade of Road

<u>Design Speed, V (MPH)</u>	<u>SSD (ft)</u>	<u>K</u>	<u>Length of Vertical Curve (L=KA)</u>									
			<u>A=1.2⁽¹⁾</u>	<u>A=2</u>	<u>A=3</u>	<u>A=4</u>	<u>A=5</u>	<u>A=6</u>	<u>A=7</u>	<u>A=8</u>	<u>A=9</u>	<u>A=10</u>
25	155	26	--	52	78	104	130	156	182	208	234	260
30	200	37	--	74	111	148	185	222	259	296	333	370
35	250	50	--	98	147	186	245	294	343	392	441	490
40	305	64	50	128	192	256	320	384	448	512	576	640
45	360	79	50	158	237	316	395	474	553	632	711	790
50	425	96	50	192	288	364	480	576	672	768	864	960

(1) Speeds less than forty miles per hour (40MPH), no vertical curve is necessary. Speeds greater than forty miles per hour (40MPH), use length of fifty feet (50').

11.05 GENERAL INTERSECTION REQUIREMENTS

A. Street intersections shall intersect at ninety-degree (90°) angles. Intersection approaches for major thoroughfares shall remain perpendicular for a minimum distance equal to the corresponding design speed Stopping Sight Distance (SSD) identified in Table 11.3. For minor collector and/or local street intersections, a five-degree (5°) tolerance is allowable.

- B. Curb radii, measured from the face of curb, shall be twenty-five feet (25') minimum on local residential and minor collector streets, and thirty-five feet (35') minimum on major collectors and major thoroughfares. The minimum curb radii shall be fifty feet (50') or more, depending on an evaluation of vehicular types and volumes, in commercial or industrial areas. Minimums shall be increased at skewed intersections.
- C. Intersections of major thoroughfares shall maintain a maximum slope of two percent (2%) along both major thoroughfares for a minimum distance of two hundred feet (200') upstream and downstream of the intersection.
- D. Intersections of collector streets with major thoroughfares shall maintain a maximum slope of two percent (2%) along the collector street for a minimum distance of one hundred feet (100') upstream and downstream of the intersection.
- E. Streets and traffic lanes shall be properly aligned across an intersection. Proposed streets shall be aligned with existing streets.
- F. When turnouts are provided at an existing street, the ultimate cross section is required to the end of curb return. If necessary, a pavement transition is required to reduce the pavement width to the existing cross section.
- G. Intersections shall be designed as a high point in the drainage system, whenever possible. Gutter lines shall not extend across traffic lanes.
- H. Streets intersecting major thoroughfares shall maintain a minimum of three hundred and fifty feet (350') of separation from another public street. Separation is defined as the distance from pavement face of curb to pavement face of curb. Streets intersecting collector streets shall maintain a minimum of two hundred and fifty feet (250') of separation. Local streets shall maintain a minimum separation of two hundred feet (200'). Collector and local street separation may be reduced with specific approval from the Director of Public Works.
- I. Offset intersections, including driveways, are not permitted on any major thoroughfare if the offset distance (or clearance between streets) is less than the minimum allowable median length.
- J. Metropolitan joint intersections are not allowed.
- K. Lane drop transitions shall extend beyond intersections a minimum distance based upon the speed limit of the roadway, in accordance with the following formulas:

For posted or design speeds of 30 mph or less:

$$\frac{\text{speed}^2(\text{mph}) \times \text{offset width (feet)}}{60} = \text{Transition length(feet)}$$

For posted or design speeds 35 mph or greater:

$$\text{Offset width (feet)} \times \text{speed (mph)} = \text{Transition length (feet)}$$

- L. Pavement width transitions shall meet or exceed requirements of the Texas Manual of Uniform Traffic Control Devices and AASHTO.
- M. Signalized intersections shall not be located closer than 1,200 feet apart and are subject to approval of the Director of Public Works.

11.06 INTERSECTION RIGHT-OF-WAY REQUIREMENTS

- A. Right-of-way width for a 6-lane thoroughfare that intersects a 4-lane or 6-lane thoroughfare shall be one hundred forty feet (140') for a distance of two hundred feet (200') and then taper to the standard ROW width, as required in Section 11.05.H, with a 150 foot minimum taper. See Figure 11.3.

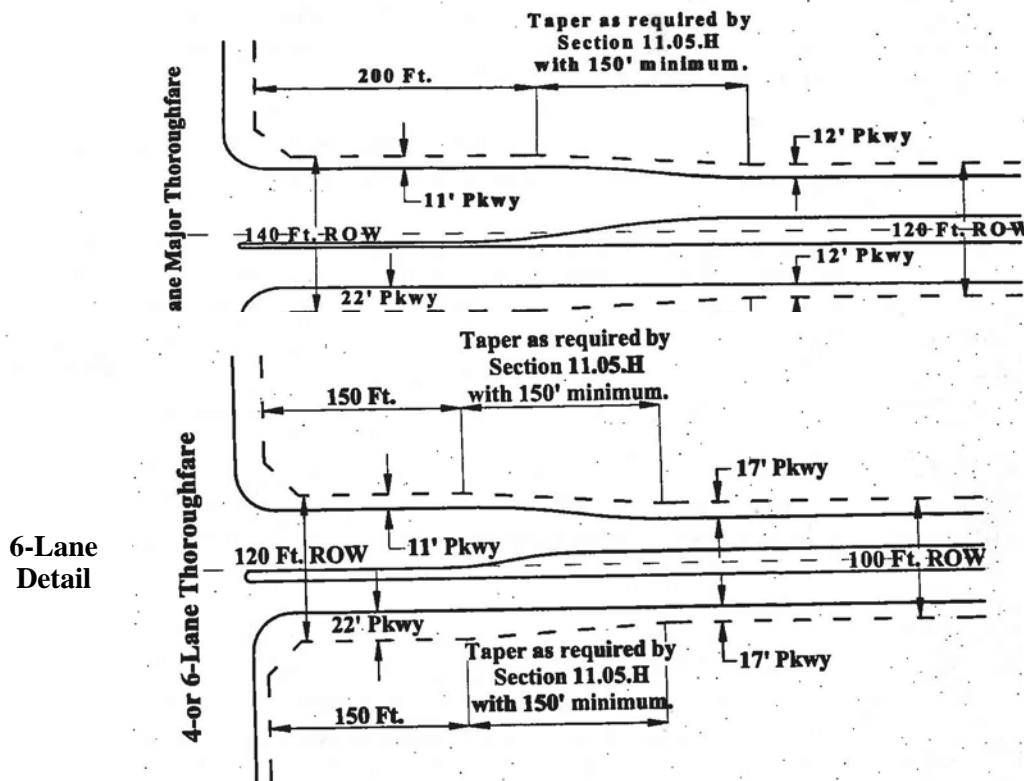


FIGURE 11.3: Intersection

- B. Right-of-way width for a 4-lane

thoroughfare that intersects a 4-lane or 6-lane thoroughfare shall be one hundred twenty feet (120') for a distance of one hundred fifty feet (150') and then taper to the standard ROW width, as required in Section 11.05.H, with a 150 foot minimum taper. See Figure 11.4.

FIGURE 11.4: 4-Lane Intersection Detail

- C. Right-of-way width for a collector street that intersects a 4-lane or 6-lane thoroughfare shall be

ninety feet (90') for a distance of one hundred fifty feet (150') and then taper to the standard ROW width, as required in Section 11.05.H, with a 150 foot minimum taper. See Figure 11.5.

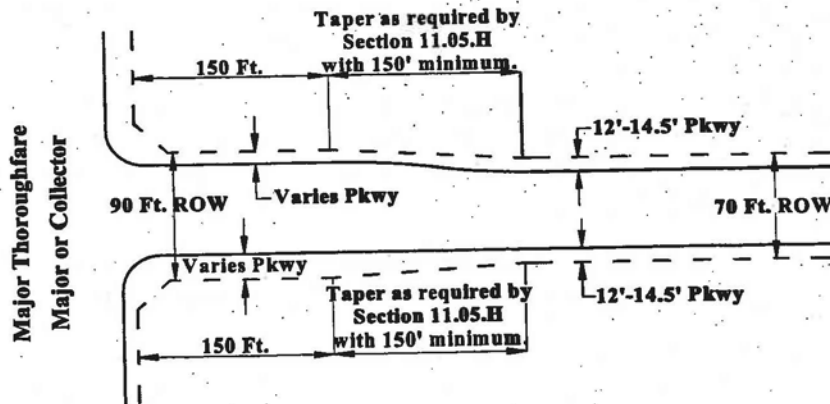


FIGURE 11.5: Major Collector Intersection Detail

- D. Bike Lane Consideration – If a thoroughfare is designated as a bike route, the width of the outside lane and the width of the right-of-way shall be increased by five feet (5’).

11.07 MEDIAN, LEFT-TURN LANE, RIGHT-TURN LANE, DECELERATION LANE AND ISLAND DESIGN

- A. Minimum bay storage lengths may need to be calculated as per traffic analysis. The referenced standards are minimum requirements. Middle block left turns may be permitted when specifically approved by the Director of Public Works.
- B. Median openings on major thoroughfares, when areas adjoining the right-of-way are not planned for immediate development, may be spaced one thousand feet (1,000') apart, measured nose-to-nose, when specifically approved by the Director of Public Works.
- C. Required Median Openings and Left-Turn Lanes:
 - 1. Median openings on divided thoroughfares shall be required at all street intersections. Median openings may be constructed to serve non-residential driveways provided that the minimum spacing requirements listed are met. Left-turn lanes shall be provided at all median openings where a street intersects the divided thoroughfare. Left turn lanes may be required at non-residential driveways if warranted by a traffic study.
 - 2. Median openings for street intersections and non-residential driveways may be moved, closed or modified at the discretion of the City to facilitate traffic flow.
- D. Left Turn Storage
 - 1. All left-turn storage bays on divided thoroughfares shall be a minimum of eleven feet (11’) wide.

2. Storage requirements listed in Table 11.5 are absolute minimums. Storage requirements may be increased as required by a traffic study based upon actual and projected traffic demands of the properties, which will be served by the left turn lane.
3. Left-turn lanes will be delineated by with buttons and thermoplastic, as shown in the City Standard Construction Details and as approved by the City Engineer.
4. Concrete pavers or solid colored concrete pavement shall be used in the median when the median width measured from back of curb to back of curb is a distance of four feet (4') or less.

E. Left Turn Transition Length

1. The transition specifications for left-turn lane entrance areas are specified in Table 11.5. The variables used for the specification are shown in Figure 11.6.

F. Minimum Median Nose and Left Turn Bay Requirements:

1. The minimum requirements for median noses and for left turn bays shall be as shown in Table 11.5 and in Figure 11.21.

G. Minimum Spacing Between Intersections and First Mid-Block Median Opening on Divided Thoroughfares:

1. The minimum distance to the first mid-block median opening along divided thoroughfares that are immediately downstream from a major thoroughfare are shown in Figure 11.7. These distances vary from three hundred fifty feet (350') to four hundred twenty five feet (425') nose-to-nose depending on the thoroughfare type and the type of mid-block opening.

H. Median Openings:

1. Median openings at intersections shall accommodate all turning paths and crosswalks. Minimum median openings and minimum median lengths without turn bays shall be as shown in Figure 11.22.

TABLE 11.5: Minimum Left-Turn Lane Design Requirements

<u>Type of Roadway On</u>	<u>Type of Roadway At</u>	<u>Turn Lane Width(s) (ft)</u>	<u>Length of Full-Width Turn Lane (ft)</u>	<u>Transition Specifications</u>		
				<u>Length (ft)</u>	<u>R₁ (ft)</u>	<u>R₂ (ft)</u>
6-lane	6 or 4 lane	11 ⁽¹⁾	150,250 ⁽²⁾	200	500	500
4-lane	6 or 4 lane	11	150	180	500	500
6 or 4 lane	Collector	11	150	180	500	500
6 or 4 lane	Local	11	100	180	500	500
Collector	Non-Residential Driveway	11	150	180	500	500
TxDOT	All Roadways and Driveways	See TxDOT and Richmond Specifications				

⁽¹⁾ Double Left-Turn Lanes

⁽²⁾ 150' – Inside Left-Turn Lane; 250' – Outside Left-Turn Lane

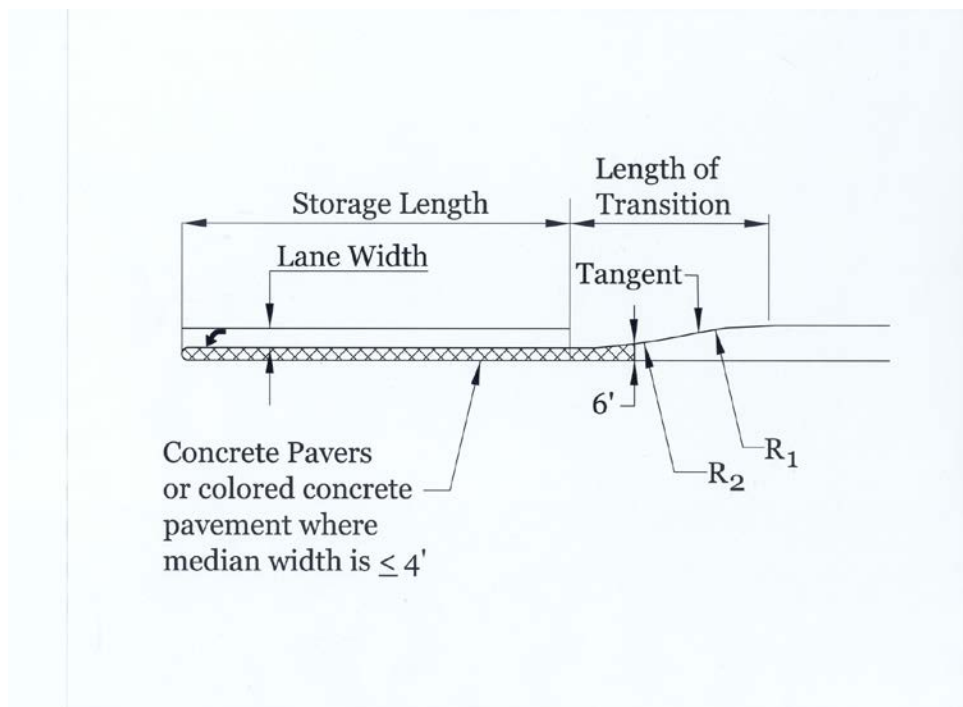


Figure 11.6: Typical Left-Turn Lane Dimensions

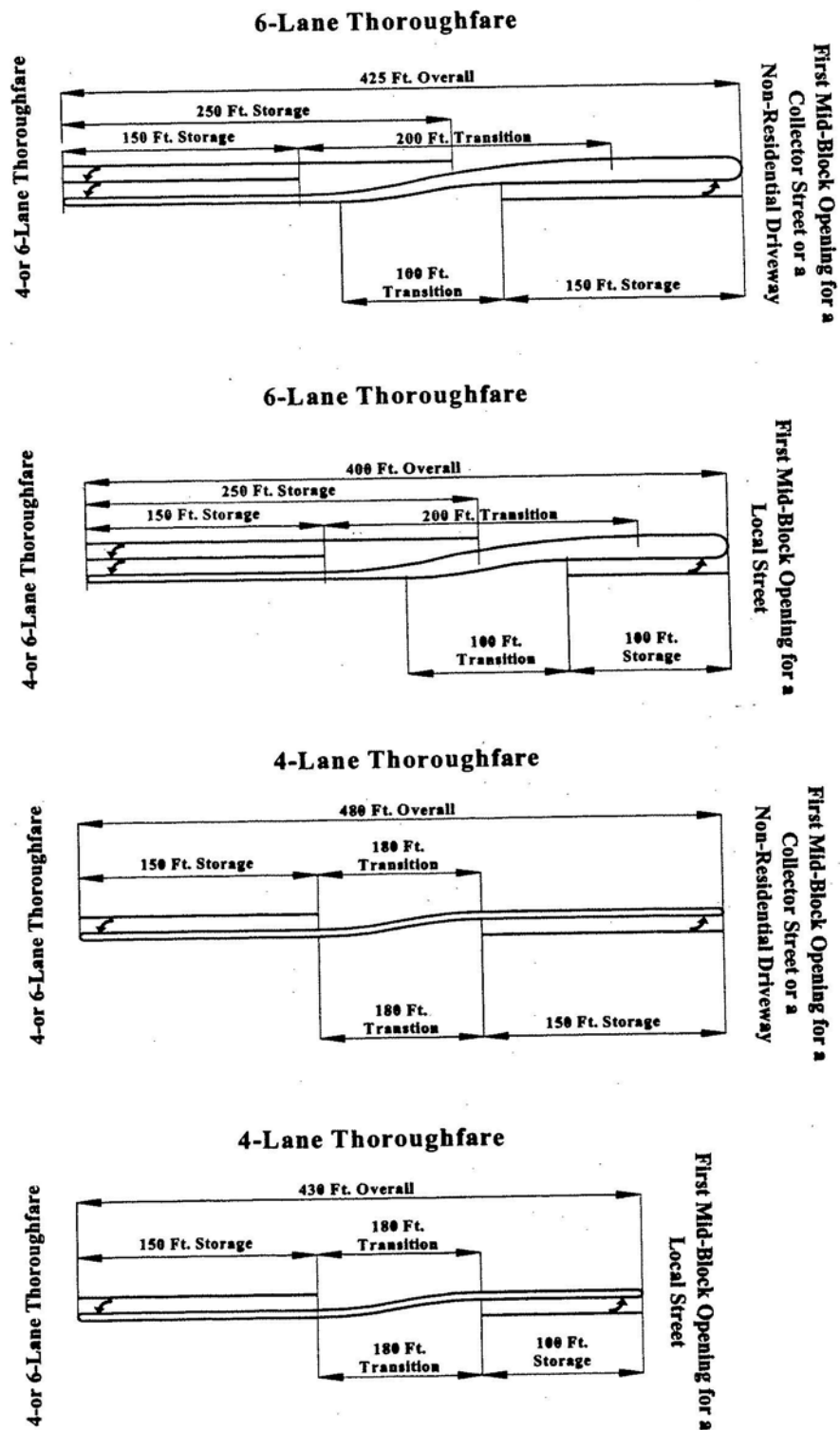


FIGURE 11.7: Minimum Spacing Between Divided Thoroughfares and First Mid-Block Median Opening on 4- or 6-Lane Thoroughfares.

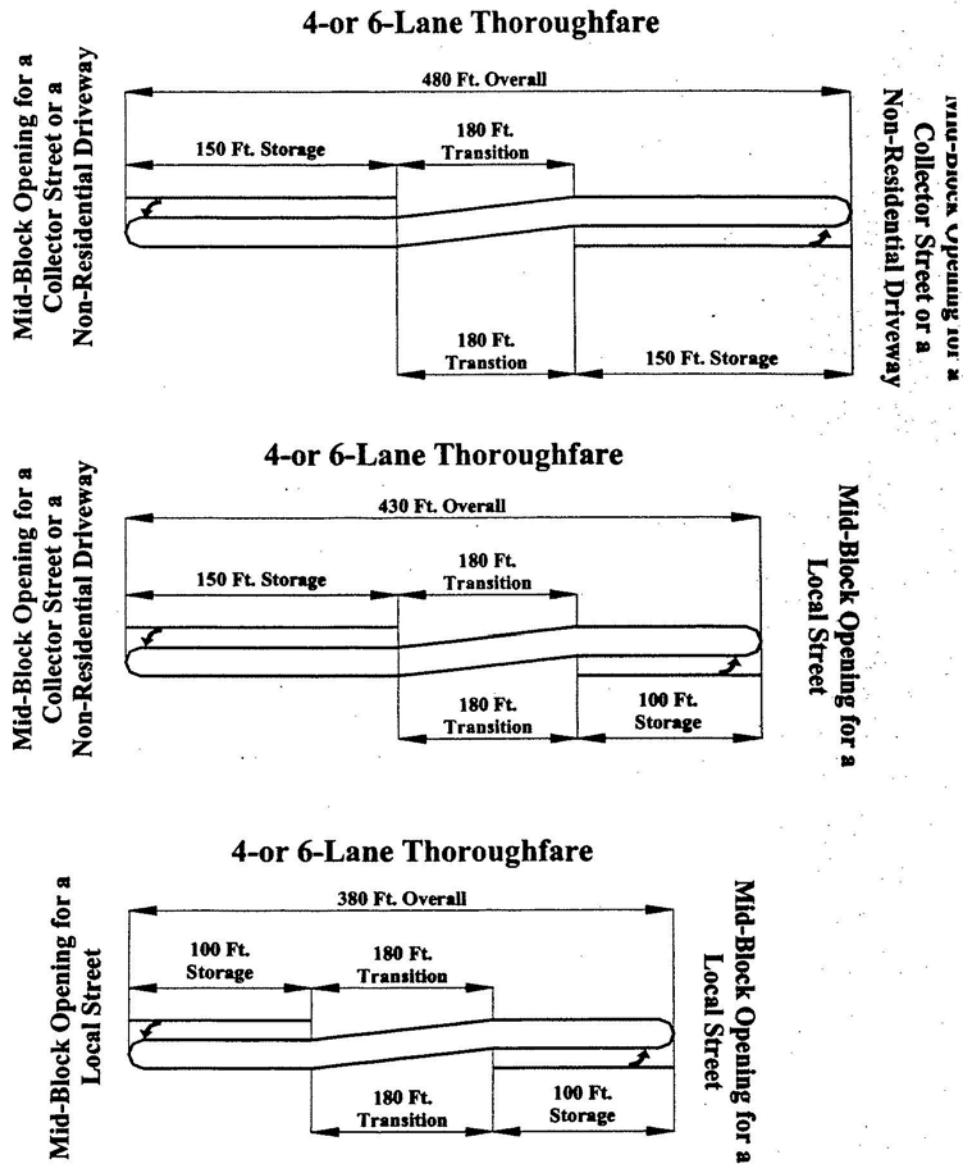


FIGURE 11.8: Minimum Distance Between Mid-Block Median Openings on a Divided Thoroughfare

- I. Minimum Distance Between Mid-Block Median Openings for Collector and Local Roadways and Driveways along Divided Thoroughfares:
 1. The minimum distance between median openings on a divided thoroughfare where left-turn storage is provided in both directions for collector or local intersecting roadways and driveways is shown in Figure 11.8. The distances shown are measured nose to nose.

J. Median Lengths:

1. The minimum length of medians shall be the sum of the required left-turn storage, transition length, ten-foot (10') tangent and length of median nose. This requirement is reflected in Figure 11.9. This is allowed, provided that access is not compromised for vacant property on the opposite side of the street.

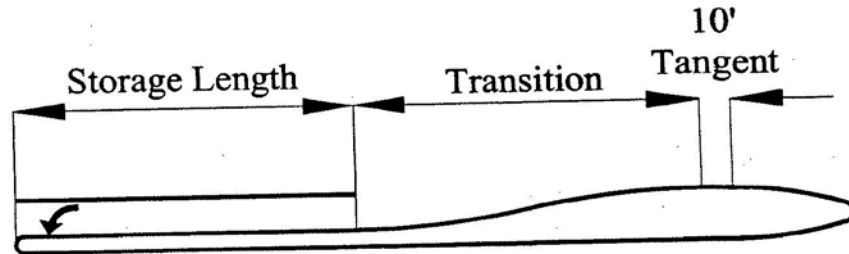


FIGURE 11.9: Minimum Length of Median

2. If a driveway is not served by a median opening, then seventy-five feet (75') of separation shall be provided from edge of driveway to the median opening.
3. If there are no turn bays in the median then the minimum median length shall be as shown in Figure 11.22.

K. Medians on Public Street Entrances to Developments:

1. Medians installed on undivided roadway entrances to subdivisions for aesthetic or any other purpose shall be a minimum of thirteen feet (13') wide and eighty feet (80') long.
2. In areas where a divided subdivision entry is constructed, the transition to the normal residential street width shall begin a minimum of fifty feet (50') upstream or downstream of the first street intersection. No part of the transition shall occur within the intersection.
3. Alternative designs may be submitted for consideration by the City Engineer.
4. All transitions shall comply with the minimum transitions specified for lane drop transitions.

L. Minimum Right-Turn Storage and Transition Length:

1. Right-Turn Lane Storage:
 - a. Right-turn lanes shall be provided at the intersection of a divided thoroughfare with another divided thoroughfare. Right turn lanes may be required at the intersection of collector streets with divided thoroughfares if traffic conditions warrant.
 - b. All right-turn storage areas shall be eleven feet (11') wide.
 - c. An additional ten feet (10') of ROW shall be provided with right-turn lanes unless adequate right-of-way to construct and maintain the right-turn lane and

adjacent improvements in the right-of-way (i.e. sidewalks) exists.

- d. Right-turn lanes shall be delineated by using buttons and thermoplastic in accordance with Richmond Standard Details and this manual.
- e. Storage requirements listed in Table 11.6 are absolute minimums. Storage requirements may increase based upon actual and projected traffic demands.
- f. A minimum separation of ten feet (10') shall be provided from a preceding driveway curb return to the transition of a right-turn lane.

2. Transition Length:

- a. The transition specifications for right-turn lane entrance areas are specified in Table 11.6. The variables used for the specification are shown in Figure 11.10.

TABLE 11.6: Minimum Right-Turn Lane Design Requirements

<u>Type of Roadway On</u>	<u>Type of Roadway At</u>	<u>Turn Lane Width(s) (ft)</u>	<u>Length of Full-Width Turn Lane (ft)⁽¹⁾</u>	<u>Transition Specifications⁽²⁾</u>		
				<u>Length⁽³⁾ (ft)</u>	<u>R₁ (ft)</u>	<u>R₂ (ft)</u>
6-lane	6 or 4 lane	11	200	180	500	500
4-lane	6 or 4 lane	11	150	180	500	500
6 or 4 lane	Collector	11	150	180	500	500
6 or 4 lane	Local	11	100	180	500	500
TxDOT	All Roadways	See TxDOT and Richmond Specifications				

⁽¹⁾ Measured from the intersecting thoroughfare ROW or stop bar.

⁽²⁾ No driveways are permitted within the transition area.

⁽³⁾ The transition lengths shown are minimum requirements, additional transition length shall be provided if required by the posted or design speed.

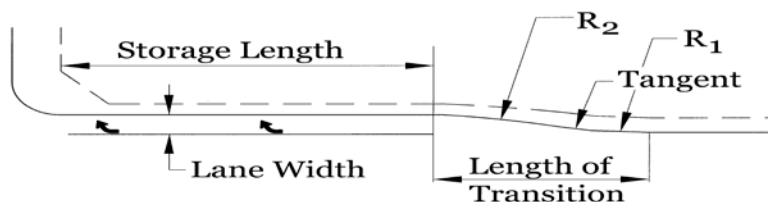


FIGURE 11.10: Typical Right-Turn Lane Dimensions

M. Minimum Deceleration Lane Storage and Transition Length:

1. Deceleration Lane Storage:

- a. Deceleration lanes shall be provided on divided thoroughfares at all non-residential driveways, except for driveways downstream of a divided thoroughfare intersection that are located in a manner that prevents the required storage and transition lengths and a 50 foot separation from the intersection curb return.
- b. All deceleration lane storage areas shall be eleven feet (11') wide.
- c. Ten feet (10') of street easement or public right-of-way, shall be provided with deceleration lanes unless adequate right-of-way top construct and maintain the right-turn lane and adjacent improvements in the right-of-way (i.e. sidewalks) exists..
- d. Deceleration lanes will be delineated by buttons and thermoplastic.
- e. Storage requirements listed in Table 11.7 are absolute minimums. Storage requirements may increase based upon actual and projected traffic demands.
- f. A tangent section of ten feet (10') shall be provided from the preceding driveway curb return to the transition of a deceleration lane.

2. Transition Length - The transition specifications for deceleration lane entrance areas are specified in Table 11.7. The variables used for the specification are shown in Figure 11.11.

TABLE 11.7: Minimum Deceleration Lane Design Requirements

<u>Type of Thoroughfare On</u>	<u>Type of intersection At</u>	<u>Turn Lane Width(s) (ft)</u>	<u>Length of Full-Width Turn Lane(ft)⁽¹⁾</u>	<u>Transition Specifications</u>		
				<u>Length(ft)</u>	<u>R₁(ft)</u>	<u>R₂(ft)</u>
6 lane	Non-Residential Driveway	11	80	110	280	280
4 lane	Non-Residential Driveway	11	60	110	280	280
TxDOT	Non-Residential Driveway	See TxDOT Specifications				

(1) Measured from the curb return of the driveway.

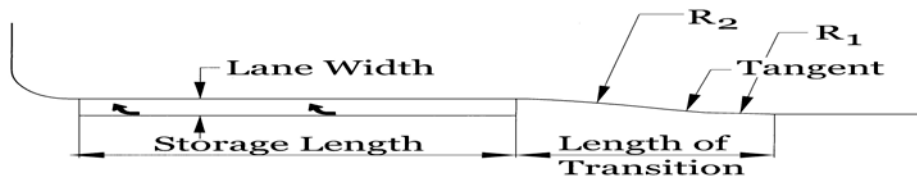


FIGURE 11.11: Typical Deceleration Lane Dimensions

11.08 ALLEY AND SERVICE ROAD DESIGN

- A. Service alleys in commercial and industrial districts shall have a minimum right-of-way width of twenty-five feet (25') and a minimum concrete pavement width of twenty feet (20'). An easement may be substituted upon approval by the City if the easement is also a fire lane easement. In residential districts, alleys should be parallel, or approximately parallel to the frontage of the street. Alleys in residential districts shall have a minimum of twenty-five feet (25') of right-of-way and fifteen feet (15') of concrete pavement. Alleys shall not be considered public right-of-way and will not be maintained by the City of Richmond.
- B. Alleys for residential, commercial and industrial districts shall meet the structural requirements in effect for the street that they are connecting to.
- C. Alleys shall have a minimum gradient on gutter line of 0.30 percent.

- D. Alleys shall be constructed as a "V" section with cross slopes of three-eighths-inch (3/8").
- E. Alley Intersections:
 - 1. Alleys shall not intersect any major collector or higher class roadway. Alley curb radii shall be a minimum of fifteen feet (15').
 - 2. All alley intersections with streets shall be perpendicular at the intersection of the ROW lines.
 - 3. Alleys shall not be considered public right-of-way and will not be maintained by the City of Richmond.
 - 4. Alleys shall not align with existing streets such as to create a four-way intersection.
 - 5. Alleys shall not align across from future streets to create an intersection.
 - 6. Internal alley-to-alley intersections shall be offset, from the centerline, a minimum of one hundred feet (100').
 - 7. No fence, wall, screen, sign, structure, or foliage of hedges, trees, bushes, or shrubs that interferes with required sight distances shall be erected, planted or maintained in any alley ROW.

11.09 GATED DEVELOPMENT ENTRANCE REQUIREMENTS

- A. Gated developments shall have a median divided street that will allow for a vehicular u-turn prior to the gate in the event that access is denied. The turn-around shall be a minimum of eighteen feet (18') in width.
- B. Entry gates shall be set back from the ROW a minimum of sixty feet (60') to provide stacking. There shall be a minimum of forty feet (40') to the entry keypad or first stop to allow room for the longest queue of vehicles expected to access the gate.
- C. The travelway shall be a minimum of twenty-four feet (24') in width. See Figure 11.12.
- D. The hinge point of the gate shall be a minimum of eighteen inches (18") behind back of the curb.
- E. Gates shall be equipped a Knox box for emergency access.
- F. Vehicular gates shall not encroach on public sidewalks.
- G. Any alternative designs require specific staff approval.

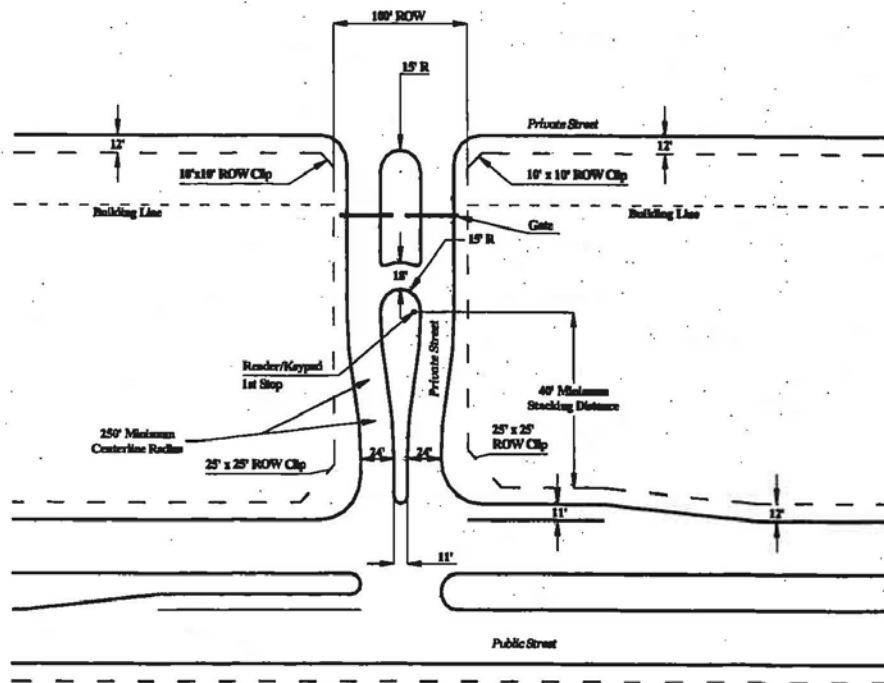


FIGURE 11.12: Gated Entrance Detail

11.10 SIDEWALK AND TRAIL DESIGN

- A. Definition of Sidewalk - A sidewalk is defined as that paved area in a street ROW or adjacent easement that is between the curb lines or the edge of pavement of the roadway and the adjacent property or easement lines that is designed for the use of pedestrians. The maximum grade of the sidewalk shall be one-half-inch (1/2") per foot. The maximum cross-fall of the sidewalk shall be one-quarter-inch (1/4") per foot. Sidewalks shall conform to the latest ADA and TDLR requirements and to the following standards.
- B. Residential Areas (Single Family and Duplex) - A concrete sidewalk, five feet (5') in width, shall be located within the street ROW, not more than two feet (2') feet from the ROW line unless pre-existing physical encroachments (e.g., utility infrastructure or trees) dictate otherwise. Sidewalks shall be constructed on both sides of all streets. Sidewalks and parkways (curb to ROW) shall be graded at one-quarter-inch (1/4") per foot above the top of the street curb. Construction of a sidewalk along a single-family residential local street may be deferred until a lot is improved, provided there is a note regarding sidewalk construction on the subdivision plat. The homebuilder shall construct sidewalks for residential lots.
- C. Non-Residential Areas and Apartment Complexes - A concrete sidewalk, five feet (5') in width, shall be located in street ROW not more than two feet (2') from the ROW line. Sidewalks shall be constructed on both sides of all streets. If other materials are placed in the ROW between the sidewalk and curb, the material shall meet City specifications and be of a color and texture distinctly different from the sidewalk and specified on the site plan.
- D. Meandering Sidewalks - Sidewalk easements adjacent to the standard ROW will be required, if necessary, for meandering sidewalks. If landscape reserves of sufficient width are platted

adjacent to the right-of-way and include public walks as an allowable use on the plat, additional sidewalk easements are not required. The near edge of the sidewalk closest to the street shall be located not less than two feet (2') from the back-of-curb and shall meander into the sidewalk easement. Sidewalk easements shall provide a minimum clearance of two feet (2') beyond the rear edge of the sidewalk.

- E. Exceptions - If it should be necessary to construct the walk immediately adjacent to the street curb line, the walk shall be a minimum of six feet (6') in width. At no time shall the near side of the walk away from the street be less than five feet (5') away from the back of curb. If the required sidewalk is to be placed outside of the street ROW, it must be placed in a sidewalk easement. Approval of planned exceptions and sidewalk easements shall be made at the time of site plan or plat approval.
- F. Areas with Screening Walls or Community Fencing - In areas where a screening wall is provided, a meandering sidewalk shall be provided and shall not encroach any closer than two feet (2') from the wall.
- G. Sidewalks on Bridges - All street bridges on major thoroughfares and major collectors shall have a sidewalk constructed on each side of the bridge. Pedestrian access/routing shall be provided on all bridges on all streets. The sidewalk shall be a minimum of six feet (6') wide with a parapet wall or traffic rail provided a minimum of two feet (2') behind the back of curb of the roadway. A standard pedestrian bridge rail protecting the sidewalk shall be provided on the outside edge of the bridge. See Figure 11.13.

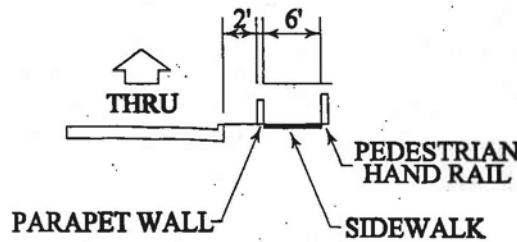


FIGURE 11.13: Bridge Parapet Wall and Pedestrian Rail

- H. Sidewalks on Box Culvert Crossings – All box culvert crossings shall have a sidewalk constructed on each side of the culvert. The sidewalk shall be a minimum of five feet (5') wide with a standard pedestrian handrail as shown in Figure 11.13 provided on the outside edge of the culvert unless the drop off is greater than 10 feet from the outside edge of the sidewalk.
- I. Sidewalk wheelchair ramps shall be required at all intersections. They shall be installed in accordance with ADA/TDLR requirements and the City of Richmond Standard Construction Details. The intersections of cul-de-sacs that do not have a defined straight section of cul-de-sac and a cul-de-sac bulb do not have to install wheelchair ramps at the intersection. Wheelchair ramps shall be located in front of any stop/yield signs or stop bars as shown on the City of Richmond Standard Construction Details. Crosswalks shall be installed as required by the City.
- J. All wheelchair ramps shall have raised detectable warning surfaces (truncated domes) in accordance with accessibility requirements and Richmond Standard Construction Details.
- K. Sidewalk construction across an esplanade: When required, raised esplanades shall be cut to

allow for the continuation of crosswalks at grade. At grade sidewalks across esplanades shall be a minimum of six feet (6') wide. Patterned concrete or brick may be used with specific approval of the Department of Public Works.

- L. All sidewalks are to be constructed in accordance with the City of Richmond Standard Construction Details.

M. Trails

- 1. Trails of ten feet (10') minimum in width when required to be constructed in accordance with the adopted City of Richmond Trail Plan.
- 2. All trails are to be constructed in accordance with the City of Richmond Standard Construction Details.

11.11 PUBLIC RIGHT-OF-WAY VISIBILITY REQUIREMENTS

- A. Adequate sight distance at the intersection of all streets shall be assured. This sight distance is provided through the use of a Corner Visibility Triangle and/or a Sight Line Triangle. Construction plans for roadways shall show both the Corner Visibility Triangle and the Sight Line Triangle on the plan view of proposed streets. Corner Visibility Triangles shall be dedicated as ROW and Sight Line Triangles shall be identified and dedicated as Visibility, Access and Maintenance Easements or Reserves (VAM's). In addition, a Sight Line Triangle must also be provided for the following cases:

- 1. Where a driveway, alley, or any roadway that is controlled by a stop sign intersects with an uncontrolled thoroughfare.
- 2. On any signalized intersection approach where right-turn on red operation is permitted, a sight line triangle must be provided for the right turn driver.

B. Corner Visibility Triangle Defined:

- 1. The corner visibility triangle is defined at an intersection by extending the two ROW lines from their point of intersection to a distance as shown on Table 11.8. These two points are then connected with an imaginary line to form the corner visibility triangle as shown in Figure 11.14. If there are no curbs existing, then the triangular area shall be formed by extending the property lines for a distance of thirty feet (30') from their point of intersection.

TABLE 11.8: Corner Visibility Triangle Distances

<u>Type of Roadway</u> <u>On</u>	<u>Type of Roadway</u> <u>At</u>	<u>Distance</u> <u>(X)</u>
4 or 6 lane	ALL	25'
Collector	Collector	25'
Collector	Local	10'
Local	Local	10'

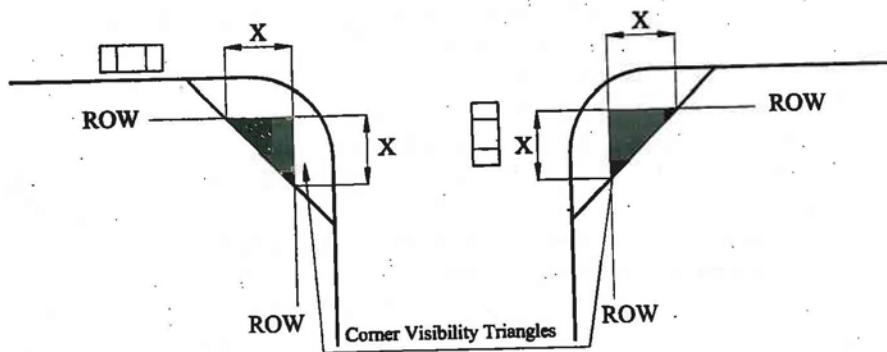


FIGURE 11.14: Corner Visibility Triangle for an Intersection

- Where alleys intersect public streets, the corner visibility triangle is measured as fifteen feet (15') along the residential street ROW and five feet (5') along the alley ROW from the point of intersection. These two points are then connected with an imaginary line to form the corner visibility triangle as shown in Figure 11.15. The alley corner visibility triangle shall be dedicated as ROW.

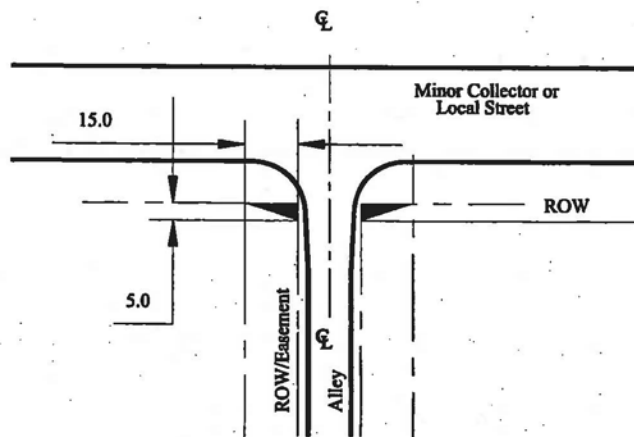


FIGURE 11.15: Corner Visibility Triangle for an Alley

C. Sight Line Triangle Defined:

- The sight line triangle is formed by first extending a line along the center line of the proposed roadway or driveway that begins at the tangent curb of the intersecting roadway

and extends to its endpoint fifteen feet (15') into the proposed thoroughfare or driveway. For the sight line triangle to the left, construct a second imaginary line that is parallel to and five feet (5') out from the intersecting thoroughfare's curb that begins at the centerline of the side street and continues to the left for a distance L to its endpoint. To complete the sight line triangle, connect the endpoints of the first two lines as shown in Figures 11.16 and 11.17. In the case of the sight line triangle to the right, the second imaginary line is parallel and five feet (5') out from the nearest edge of the conflicting traffic flow (or adjacent median in the event of a divided roadway). It begins at the centerline of the side street and continues to the right for a distance R to its endpoint (See Figures 11.16 and 11.17). On divided roadways with a median width greater than 30 feet, sight line triangles shall be generated at the intersecting roadway and at the median opening.

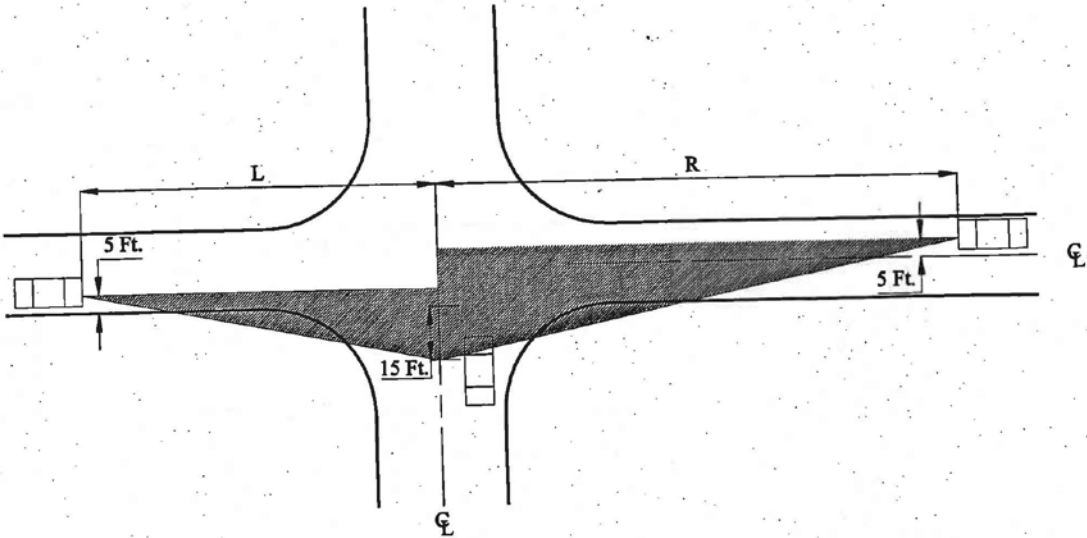
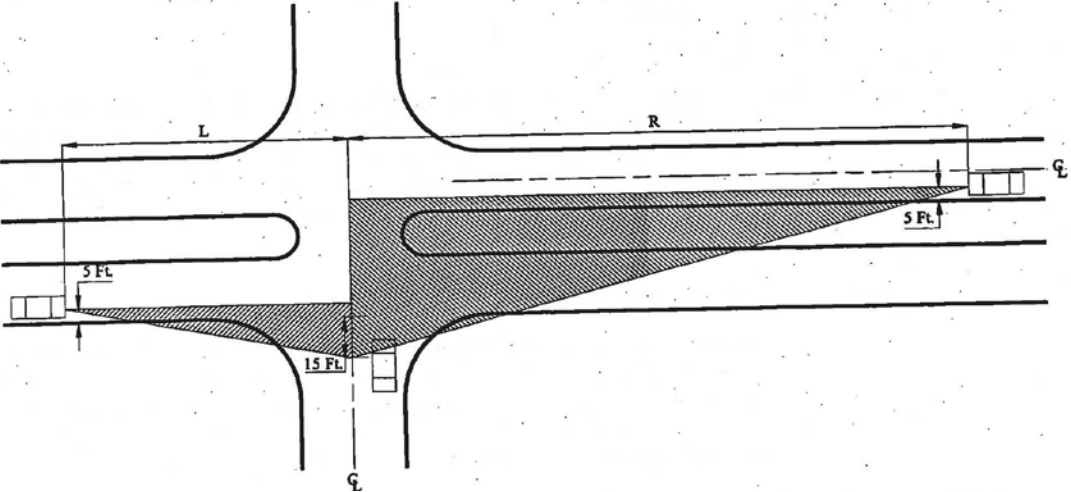


FIGURE 11.16: Typical Sight Line Triangle (multi-lane approaches require similar analysis)



**FIGURE 11.17: Typical Sight Line Triangle for a Divided Thoroughfare
(multi-lane approaches require similar analysis)**

2. Distance to driver’s eye for all roadways and driveways that intersect a street is fifteen feet (15’) from the intersecting curb line as shown in Figures 11.16 and 11.17.
3. In the case where the thoroughfare contains existing horizontal curvature, the distances L and R must be measured along the horizontal curve.

TABLE 11.9: Sight Line Triangle Distances

<u>Design Speed</u> <u>V (MPH)</u>	<u>SD to Left</u> ⁽¹⁾ <u>L (ft)</u>	<u>SD to Right by Lanes in Cross Section</u>		
		<u>R (ft)</u>		
		<u>2</u>	<u>4</u> ⁽²⁾	<u>6</u> ⁽²⁾
30	325	325	N/A	N/A
35	425	425	N/A	N/A
40	525	525	N/A	N/A
45	625	625	650	N/A
50	725	725	750	775

(1) Source AASHTO Green Book

(2) Manual Calculations of the Procedure in the Green Book indicate a twenty-five-foot (25’) increase in sight distance to the right for each increase in cross section.

D. Landscaping and Obstruction Requirements for Corner Visibility and Site Line Triangles:

1. No fence, wall, screen, sign, structure, foliage, hedge, tree, bush, shrub, berm, driveway planting, parking, or any other item, either man-made or natural shall be erected, planted, or maintained in a position that will obstruct or interfere with a driver’s clear line of sight within both the corner visibility and sight line triangle (i.e., VAM’s).
2. Vision at all intersections shall be clear from obstructions at elevations between thirty inches (30”) and ten feet (10’) above the average gutter elevation within each sight line triangle. Existing trees shall have a clear trunk of eight feet (8’) above average gutter elevation within each sight triangle. Traffic control devices shall remain visible at all times in accordance with the requirements of the TMUTCD.

E. Landscape Plan Requirements:

1. A sitework/landscape plan is required that shows the plan of the street on both sides, and the median where necessary, of each proposed driveway/street to the proposed development with the grades, curb elevations, proposed street/drive locations, and all items (both natural and man-made) within both the corner visibility and sight line triangles.
2. This sitework/landscape plan shall show no horizontal or vertical restrictions (either existing or future) within the corner visibility and sight line triangles.

11.12 PAVEMENT STRUCTURE REQUIREMENTS

- A. Local residential streets (60' ROW) and minor collector streets (60' ROW) shall have a minimum thickness of six inches (6") with number four (#4) reinforcing bars spaced at eighteen inches (18") measured center to center of the rebar. All transverse paving headers shall be spaced at a maximum of sixty feet (60'). Lap splices will be staggered in adjacent bars. Minimum overlap shall be eighteen inches (18").
- B. Major collector streets (70' ROW) and all streets in multi-family residential, commercial or industrial areas shall have a minimum thickness of seven inches (7") with number four (#4) reinforcing bars spaced at eighteen inches (18") measured center to center of the rebar. All transverse paving headers shall be spaced at a maximum of sixty feet (60'). Lap splices will be staggered in adjacent bars. Minimum overlap shall be eighteen inches (18").
- C. Major thoroughfares (> 70' ROW) shall have a minimum thickness of eight inches (8") with number four (#4) reinforcing bars spaced at eighteen inches (18") measured center to center of the rebar. All transverse paving headers shall be spaced at a maximum of sixty feet (60'). Lap splices will be staggered in adjacent bars. Minimum overlap shall be eighteen inches (18").
- D. The design engineer is responsible to insure that the pavement structure is designed to withstand the anticipated loads that are expected on the roadway.
- E. Hot-mix asphaltic concrete pavement shall be designed for each individual project based on a geotechnical analysis prepared by a registered engineer. Minimum requirements shall include two inches (2") of surface course, eight inches (8") of stabilized, crushed concrete or stabilized limestone base, and six inches (6") of lime stabilized subgrade. Minimum design parameters shall be in accordance with the AASHTO Design Guidelines for Flexible Pavement, latest edition.
- F. Subgrade shall be stabilized to a minimum eight inches (8") thick to reduce Plasticity Index (PI) to twenty (20) or less with a pH of 12.4 as determined by lime series. Add one-percent (1%) for field variation. Subgrade shall be compacted to ninety-five percent (95%) standard proctor density. Alternative subgrade stabilization may be substituted when the geotechnical engineer for the project makes specific recommendations and when specifically approved by the City Engineer, however, the stabilization requirement shall not be waived. Lime shall be applied as per TXDOT 260. Subgrade stabilization and compaction shall extend a minimum of two feet (2') beyond the back-of-curb or edge of pavement.
- G. Concrete pavement thickness design is required for all pavement within industrial and commercial areas and on major thoroughfares to identify roadways where the minimum pavement thickness may need to be increased. Concrete pavement thickness design shall be based on American Association of State Highway and Transportation Officials design procedures for rigid pavements.
- H. Horizontal dowels or saw cutting full depth are required when making a connection of a proposed street to an existing concrete street. When the existing concrete street has no exposed steel or has been saw cut full depth the dowels shall be number four (#4) bars, eighteen inches (18") long, embedded twelve inches (12") and epoxied. Dowels shall be 12 inches center-to-center.

- I. Dead-end streets or ends of concrete slabs designed to be extended in the future shall have paving headers and fifteen inches (15") of reinforcing steel exposed beyond the pavement, coated with asphalt and wrapped with burlap or paving headers and Dowel type expansion joint for future pavement tie.
- J. Pavement extensions shall connect to the existing pavement with a pavement undercut and a minimum steel overlap of twelve inches (12"). Refer to Construction Details.
- K. All concrete to be removed shall be removed either to an existing joint or a sawed joint. Saw cuts shall be the full depth of the pavement.

11.13 REINFORCED CONCRETE PAVEMENT MATERIALS

- A. **Concrete** – All concrete shall be a minimum of five and a half (5.5) sacks cement per cubic yard concrete and achieve an unconfined compressive strength of 3,500 psi at twenty-eight (28) days.
- B. **Reinforcing steel** - Grade 60, ASTM A615, current.
- C. **Aggregate** – Limestone shall be utilized wherever possible. Granite is permitted only with prior approval by the City Engineer. River rock or similar “hard” aggregates are not permitted.
- D. **Fly Ash** – Fly ash is not permitted as a substitute for cement in pavement or curbs. Fly ash may be permitted, with prior approval of the City Engineer, as an admixture/additive to achieve a site-specific objective required by non-typical conditions. The inclusion of fly ash in pavement requires prior written approval of the City Engineer.
- E. All materials and workmanship shall conform to the Texas Department of Transportation Standard Specifications, 1993, and the Texas Manual on Uniform Traffic Control Devices, 1980, and any revisions thereto.
- F. All special, non-standard materials, such as colored concrete, exposed aggregate, concrete pavers or special signage that are installed by the developer, homebuilder or homeowner, shall be specifically approved by the Director of Public Works and shall be maintained by the installer/owner or his assigns, unless maintenance by the City is approved by the Department of Public Works. Any maintenance of non-standard items, not approved for City maintenance, by the City of Richmond will be done using standard materials and methods.

11.14 GRADING AND LAYOUT REQUIREMENTS

- A. Minimum gradient on gutter shall be 0.30 percent.
- B. Inlet spacing shall be as defined in Chapter 7.
- C. Maximum cut measured from finished grade at the right-of-way line to top of curb shall be 1.75 feet. The maximum slope for all driveways shall 8%. Variation of this requirement may be allowed with specific approval of the Director of Public Works.
- D. Minimum grade shall be one percent (1%) fall around intersection turnout for a minimum radius of twenty-five feet (25'). Grade for larger radius shall be determined on an individual basis.

- E. All major collector and major thoroughfare streets shall have a six-inch (6") high barrier concrete curb as shown in the City of Richmond Standard Construction Details. Minor collectors and local streets may be constructed with a 4" x 12" lay-down curb as shown in the City of Richmond Standard Construction Details. All streets within 50' of a permanent waterbody must have standard 6" curb installed. All streets within 30' from curb to the high bank must include a guard rail analysis. At the intersection of a 6" barrier curb and a 4" X 12" lay-down curb, the 6" curb shall be continued around the curb return of the lesser street as shown in the City of Richmond Standard Construction Details.
- F. Minimum slope for the gutter of a cul-de-sac shall be 0.60 percent.
- G. The amount of cross slope over the pavement section should be shown on the plans. The usual cross slope is three-eighths inch (3/8") per foot from the curb line to quarter point, and one-fourth-inch (1/4") per foot from quarter point to centerline, and one-eighth-inch (1/8") per foot for left turn lanes.
- H. When connecting to an existing curbed street, the gutter lines for the proposed and existing streets shall be matched.
- I. Proposed top of curb elevations should be designed to match the top of the curb at an existing inlet.
- J. Top of curb elevations shall be shown on the construction plans.
- K. Gutter elevations are required for vertical curves where a railroad track is being crossed.
- L. Where railroad crossings are not at right angles to the pavement slab, vertical curves should be calculated for each curb line and should be posted at ten-foot (10') intervals in the profile.
- M. When meeting an existing curb-and-gutter street, top-of-curb elevations shall be designed to meet an elevation six inches (6") above the existing gutter. At existing inlets, top-of-curb elevations shall be designed to match existing top-of-curb elevations.
- N. Adjust existing manhole frames and covers within the limits of the proposed pavement to meet the proposed top-of-slab elevation.
- O. Adjust existing manhole frames and covers outside the limits of the pavement to conform to the final grading plan.

11.15 CUL-DE-SAC PAVEMENT

- A. Public streets shall not dead-end without a cul-de-sac.
- B. Single family residential - pavement radius measured to the face of curb shall be forty feet (40'). Multi-family residential, commercial and industrial - pavement radius measured to the face of curb shall be fifty feet (50').
- C. The minimum pavement radius for a cul-de-sac bulb without a median shall be forty feet (40') for single family residential areas and fifty feet (50') for multi-family residential, commercial and

industrial areas. The minimum right-of-way radius shall be ten feet (10') greater than the minimum pavement radius. The right-of-way radius shall be clear of permanent obstructions. See Figure 11.19 for minimum cul-de-sac requirements.

- D. The minimum pavement radius for a cul-de-sac bulb with a median shall be forty feet (40') plus the radius of the median for single-family residential areas. The minimum right-of-way radius shall be ten feet (10') greater than the minimum pavement radius. The right-of-way radius shall be clear of permanent obstructions. See Figure 11.19 for minimum cul-de-sac requirements.
- E. The distance from the face of curb of a cul-de-sac to the right-of-way line shall be a minimum of ten feet (10').
- F. Curb radii at the transition to the cul-de-sac shall have a minimum radius of twenty five feet (25') in single family residential areas and thirty-five feet (35') in commercial areas, measured at the face of curb.
- G. The length of a cul-de-sac is defined as the distance from the centerline of the intersecting pavement to the center of the cul-de-sac bulb measured along the centerline of the street right-of-way. Maximum length of cul-de-sac streets for single-family residential subdivision shall be one thousand two hundred feet (1,200') or serve a maximum of twenty-eight (28) residential lots, whichever is less. Maximum length of cul-de-sac streets for multi-family commercial or industrial developments shall be eight hundred feet (800').
- H. The minimum grade line around a cul-de-sac shall be 0.60 percent.

11.16 TRAFFIC CONTROL DEVICES

- A. Standard barricades shall be permanently installed at the end of all dead-end streets not terminating in a cul-de-sac and at all turnouts. Barricades shall meet requirements of the Texas Manual of Uniform Traffic Control Devices for Type III barricades.
- B. Traffic and street signage locations shall be shown on the paving plan in the construction plans. Traffic signs shall conform to the requirements of the Texas Manual of Uniform Traffic Control Devices as adopted by the City of Richmond. Prior to final approval of a construction project, all signage shall be installed in accordance with the approved construction plans.
- C. Standard signage shall be flat blank aluminum, covered with round prismatic grade sheeting mounted on two and three-eighths inch ($2 \frac{3}{8}$ ") by twelve-foot (12') long galvanized post with vandal-proof mounting brackets and breakaway bases. Posts shall be Telespar Unistrut or approved equal. Traffic control signage shall meet the requirements of the Texas Manual for Uniform Traffic Control Devices. Refer to the City of Richmond Standard Construction Details.
- D. Pavement markings shall be shown on the approved construction plans for all projects. Flint Trading Thermoplastic or approved equal with supplemental reflectors, or approved alternate, shall be used on all streets. Thermoplastic shall be applied with Pliobond 10 adhesive or approved equal. Turn lanes shall have proper pavement markings. A blue reflectorized button is required at all fire hydrants located one foot (1') off the pavement centerline toward the fire hydrant. Pavement markings shall be installed as shown on the approved construction plans and per City of Richmond Standard Details.

- E. Street layouts shall be designed to avoid the use multi-way stop signs in new developments to the maximum extent practicable.
- F. Developer shall install traffic control devices as warranted by an engineering analysis or traffic study. The traffic study shall be performed by the developer and is subject to the approval of the Richmond Director of Public Works.
- G. Street names shall be limited to a maximum number of characters, including spaces between individual words as follows. Spaces count as two (2) characters.
 - 1. Street names on major thoroughfares and major collectors: 30 characters
 - 2. Street names on all other streets: 20 characters

11.17 TRAFFIC CALMING GUIDELINES

A. Introduction:

- 1. Traffic Calming, a concept that dates back to the 1960's and 70's, has been implemented more extensively throughout the United States during the 1990's. The primary purpose of traffic calming is to decrease speeds and reduce cut-through traffic volumes. The Institute of Transportation Engineers (ITE) defines traffic calming as:

“Traffic Calming is the combination of mainly physical measures that reduce the negative effects of motor vehicle use, alter driver behavior and improve conditions for non-motorized street users.”

- 2. Urban sprawl and traffic congestion continue to increase in the United States. As a result, speeds and cut-through volumes on local streets and collectors will continue to increase unless traffic calming measures are put in place or new local and minor collector roadways are designed with traffic calming in mind.
 - 3. The Design Manual and UDC are intended to provide design and access requirements that are proactive in addressing traffic calming issues in residential areas.
 - 4. Traffic control devices such as STOP Signs and speed limit signs are regulatory measures that require enforcement. Traffic calming measures, however, are intended to be self-enforcing.
- B. The City of Richmond encourages the implementation of traffic calming philosophy in the design and retrofitting of subdivisions. The Institute of Transportation Engineers “Guidelines on Traffic Calming” and the Texas Manual on Uniform Traffic Control Devices shall be considered in the design of new subdivisions. The City may require traffic calming implementation in new subdivision design. It is the responsibility of the land planner to document consideration of traffic calming techniques in the initial design and plat process (i.e. concept plan stage).
- C. Approved traffic calming devices shall not include the installation of speed humps in either new or existing subdivisions. Other physical modifications to the standard street cross-section may be considered as a last resort. Non-standard street geometrics shall require a clearly identified, actual problem of the nature that may be resolved by the proposed physical modification. All physical modifications require prior written approval by the Director of Public Works.

- D. The City has adopted the consideration and utilization of round-a-bouts as the preferred alternative to traffic signals. All traffic signal design shall first conduct an analysis on the utilization of a round-a-bout instead of a traffic signal and present the analysis to the City for approval.

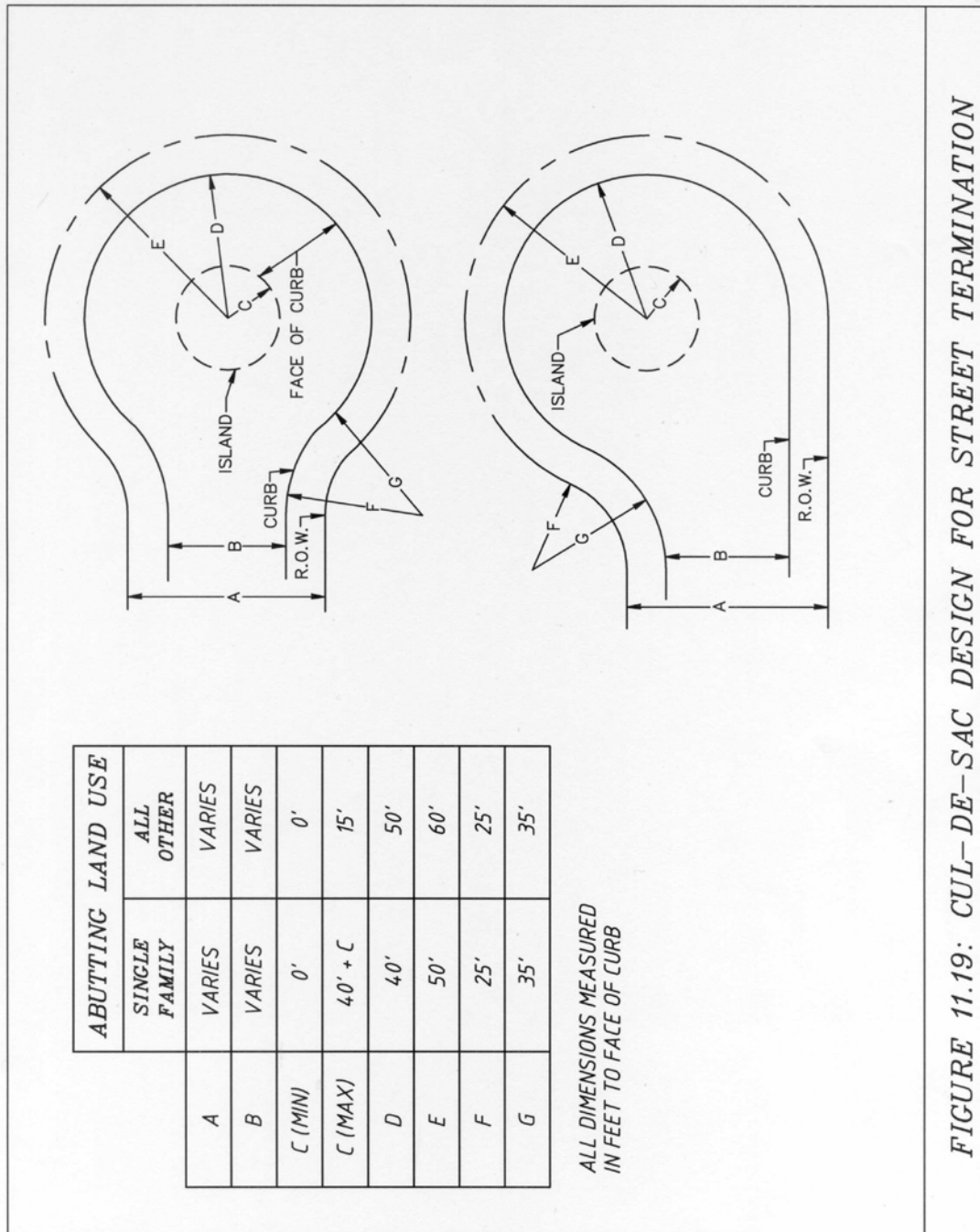


FIGURE 11.19: CUL-DE-SAC DESIGN FOR STREET TERMINATION

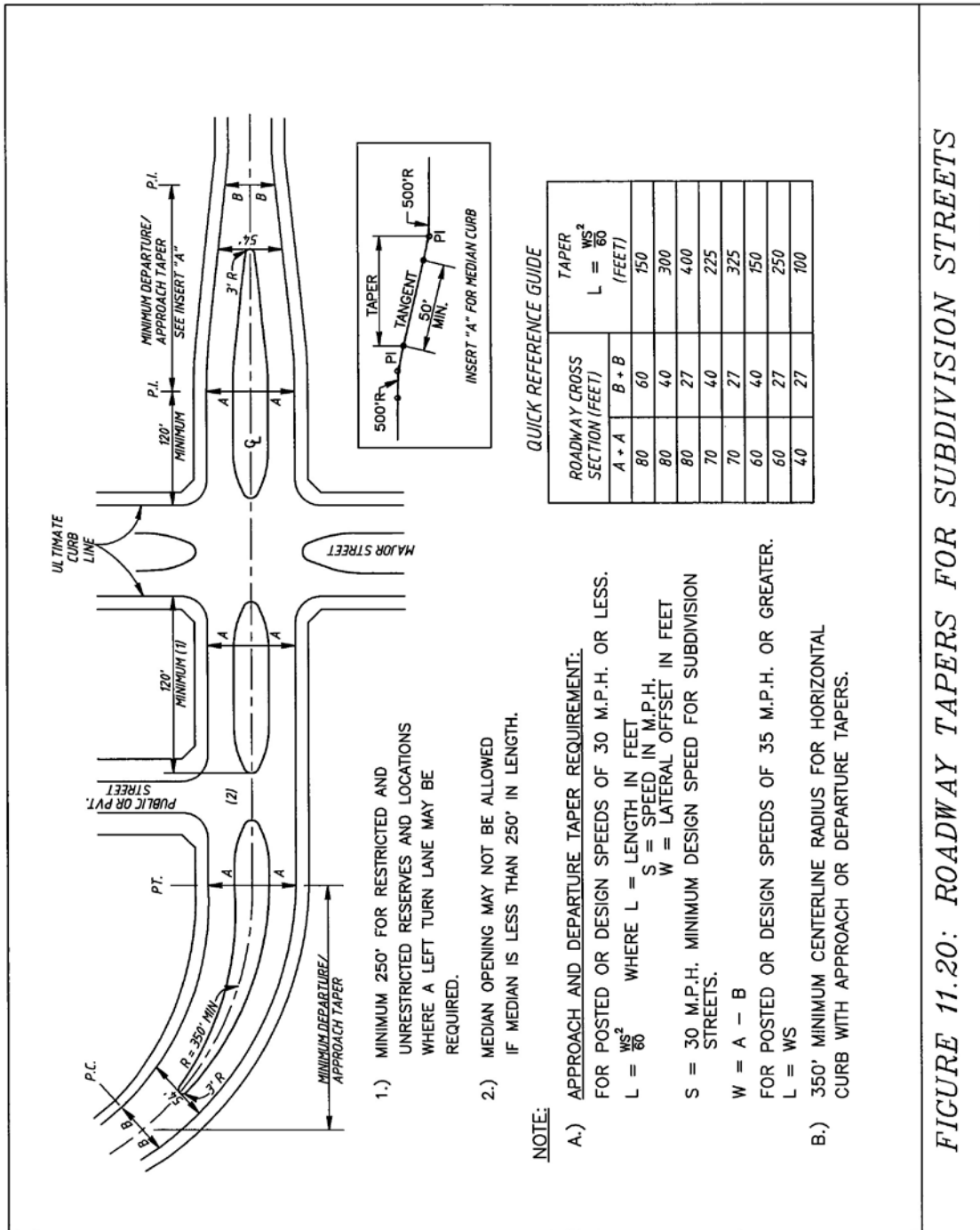


FIGURE 11.20: ROADWAY TAPERS FOR SUBDIVISION STREETS

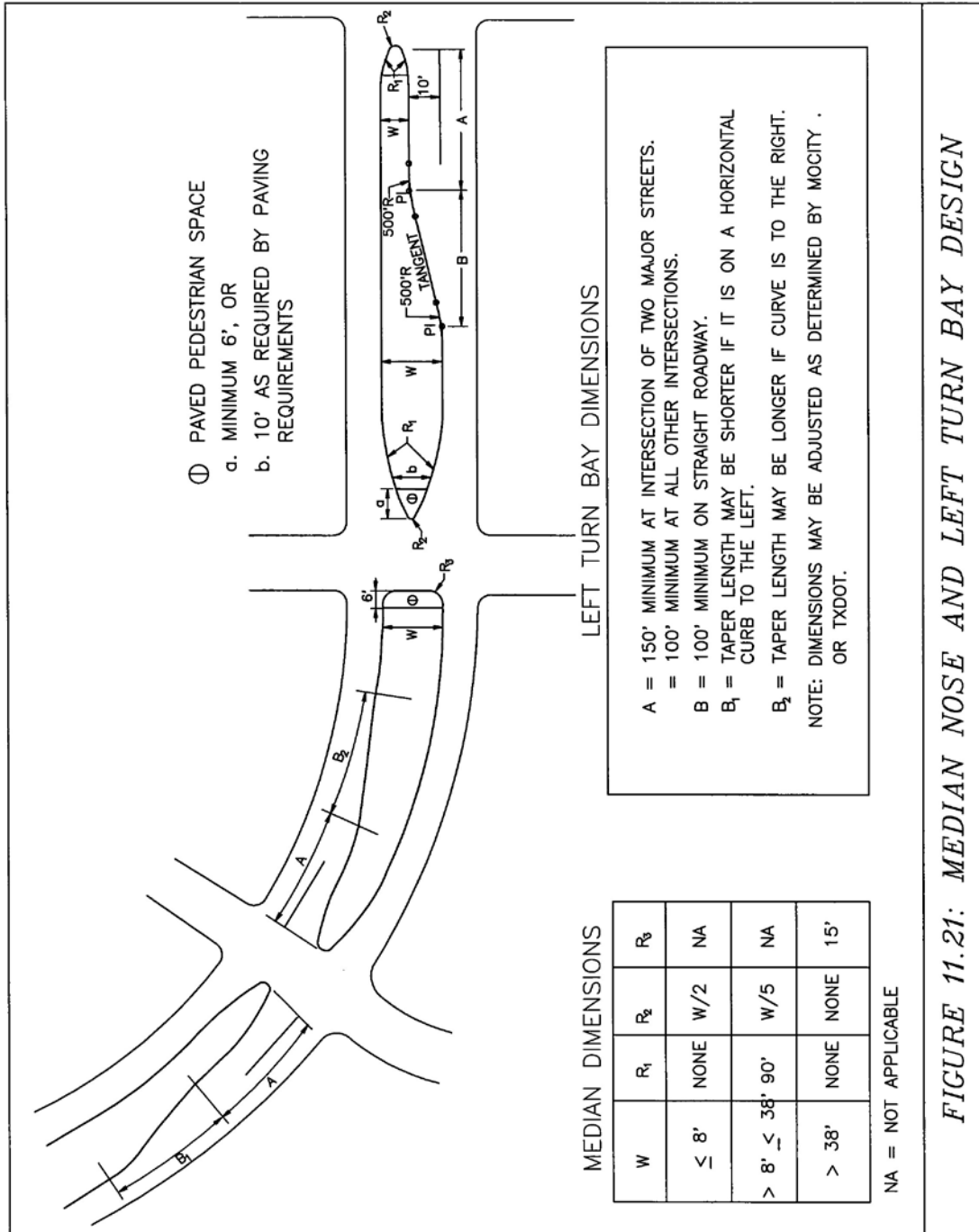


FIGURE 11.21: MEDIAN NOSE AND LEFT TURN BAY DESIGN

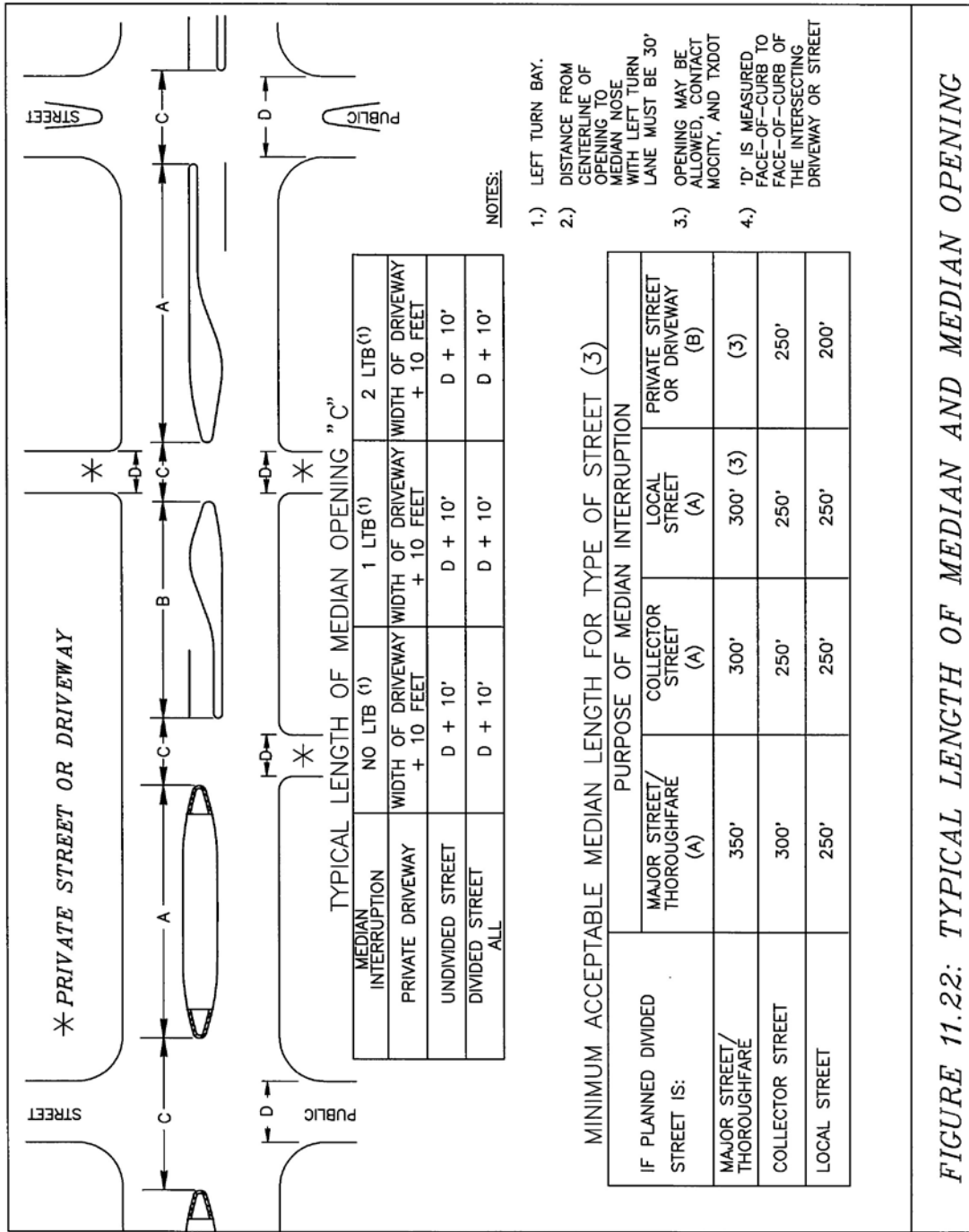


FIGURE 11.22: TYPICAL LENGTH OF MEDIAN AND MEDIAN OPENING

END OF CHAPTER



City of Richmond

Design Manual

Chapter 12

RIGHT-OF-WAY USE, UTILITY LOCATIONS & GRADING PERMIT REQUIREMENTS

CHAPTER 12

RIGHT-OF-WAY USE, UTILITY LOCATIONS AND GRADING PERMIT REQUIREMENTS

12.01 GENERAL

- A. These standards describe the general requirements for the use of public right-of-ways and public easements and the supporting documents required for permit approval by the City of Richmond. These standards also address the location requirements for franchise utilities and the requirements for placing fill or grading private property.
- B. The Richmond Public Works Department shall approve and permit all activity within the public right-of-ways and public easements and all lot fill and grading within the Richmond city limits or extraterritorial jurisdiction.
- C. Construction plans for private improvements, within public right-of-ways and public easements or that connect to or affect the public infrastructure shall be approved by the City of Richmond subject to the requirements of this manual and are subject to review and approval using the process defined in this manual.
- D. Permit fees shall be assessed in accordance with the latest Fee Schedule adopted by the Richmond City Commissioners and applicable State and Federal law.
- E. In exercising its police powers necessary to protect the health, safety and welfare of the public, the City has first priority over all other uses of the ROW. The City reserves the right to, among other things, lay water, sewer, drainage, and other pipelines or cables and conduits, and to do underground and overhead work, and attachments, restructuring, or changes in Street facilities in across, along, over, or under a public Street, alley or ROW occupied by an agency or ROW User, and to change the curb, sidewalks, or the grade of Streets.
- F. All transmission, distribution and collection structures, lines, equipment, trees and other facilities erected by a ROW user within the City shall be so located as to cause minimum interference with the proper use of the ROW, and to cause minimum interference with the rights and reasonable convenience of property owners who join any of said streets. The City reserves the right, in the Permit or otherwise, to restrict or determine the route (pathway) and/or spatial location, whether horizontal, vertical or depth, of any facility and/or structure or improvement in the ROW. The City reserves the right to reserve space for future utilities.
- G. The ROW User shall be responsible for storm water management, erosion control and excavation safety measures that comply with city, state and federal guidelines. Requirements shall include, but not limited to, construction fencing around any excavation that will be left overnight, silt fencing in erosion areas until reasonable vegetation is established and barricade fencing around open holes.
- H. The City shall take reasonable precautions, but is under no obligation, to protect non-City owned facilities during the course of roadway maintenance and improvements. The City will make

reasonable efforts to notify known users within 2 feet of back of curb of planned roadway maintenance or improvements that may impact their facilities. It is the responsibility of the installer/owner of the facilities to protect their facilities and to remove or adjust the location of their facilities as appropriate.

12.02 DEFINITIONS

For the purposes of this chapter, the following words and phrases shall have the meanings respectively ascribed to them by this section.

Emergency operations - are defined as those operations and repairs necessary to prevent damage or injury to the health or safety of the public or any person and the work necessary to address or prevent an immediate service interruption. Upgrading of facilities, new service installation and neighborhood improvement projects are not emergency operations.

Excavation - means any activity that removes or otherwise disturbs soil, pavement, driveways, curbs, or sidewalks in the ROW.

Facilities - means the equipment, and property, including but not limited to, lines, poles, mains, pipes, conduits, ducts, cables, valves, man holes, hand holes and wires located under, on, or above the surface of the ground within the ROW, and related facilities and equipment used or useful for the provision of utility services.

Pavement - shall refer to streets containing Portland cement, asphalt, brick or other rigid or semi-rigid material that covers the surface of a Street and their underlying sub grade and base.

Permit - means a permit issued by the City authorizing work in the ROW.

Permittee - means any person or ROW User to whom a permit is issued to excavate a ROW.

Repair - means the temporary or permanent construction work necessary to make the ROW useable.

Repair Area - means that area around an excavation where the pavement and subgrade is impacted by the excavation.

Restoration - means the process by which an excavated ROW and surrounding area, including, but not limited to, pavement and foundation structures, ground cover, landscaping, and monuments are returned to the same condition, or better than that which existed before the commencement of the work.

Right of Way or Public Right of Way (ROW) - means the area on, below, adjacent to or above a public roadway, street, public sidewalk, alley, waterway, or utility easement in which the municipality has an interest and shall include, but not be limited to, all easements now held, or hereafter held, by the City, but shall specifically exclude private property.

Right-of-Way (ROW) User - means a person, its successors and assigns, that uses the ROW for purposes of work, excavation, provision of services, or installing, constructing, maintaining, or repairing facilities thereon, including, but not limited to, landowners and service providers.

Routine Service Operation - means a work activity that makes no material change to the facilities and does not disrupt traffic.

Street - means the paved portion of the ROW that has been constructed, reconstructed, or resurfaced with concrete or asphalt or some other surface.

TMUTCD - shall mean the Texas Manual on Uniform Traffic Control Devices, latest edition.

Utility - means any privately or publicly owned entity which uses ROW to furnish the public any general public service, including, without limitation, sanitary sewer, gas, electricity, water, telephone, petroleum products, telegraph, heat, steam or chilled water, together with the equipment, structures, and appurtenances belonging to such entity and located within and near the ROW.

12.03 RIGHT-OF-WAY USE PERMITS

- A. Any disturbance within the roads, streets and easements of the City requires a right-of-way use permit. Such disturbances include digging or excavating anywhere within the right-of-way, installation, replacement or repair of lines, conduits and franchise utilities, erection of utility poles, installation of lights, transformers, switches and other appurtenances, installing, removing or repairing curbs, gutters, sidewalks, driveway aprons, irrigation systems, planting trees or other improvements.
- B. A right-of-way use permit is not required for street construction projects undertaken by the City pursuant to a contract between the City and its contractor; for projects permitted under other City permits or for those uses that the Director of Public Works finds to be minor in nature.
- C. A right-of-way use permit is not required for routine maintenance of existing utilities within the right-of-way that does not require a lane closure in excess of four hours and that will be completed in the same calendar day. However, maintenance activity that involves an excavation or boring within the right-of-way or a lane closure in excess of four hours does require notification of the type and location of work to the City.
- D. In the event of an emergency that demands immediate action to protect the public health, safety or welfare, when a permit cannot be reasonably or practically obtained beforehand, emergency actions may proceed provided that notification be provided to the office of the Director of Public Works, 281-342-0559, or during non-business hours to the police dispatcher, 281-342-2849.
- E. Before the issuance of a right-of-way use permit, the applicant, his agent, or contractor shall:
 - 1. Furnish evidence of insurance or self-insurance for public liability and property damage issued by an insurance company, authorized to transact business in the State of Texas. If a valid certificate is on file with the City, subsequent applications may reference the certificate on file.
 - 2. Issue a statement holding the City harmless and free of liability, to the extent allowed in Chapter 283 of the Texas Local Government Code, from work performed under the authority of the permit. If a valid certificate is on file with the City, subsequent applications may reference the certificate on file.
 - 3. Post an assurance bond or other method of guarantee acceptable to the City to ensure that the work covered by the permit will be completed in accordance with the latest edition of this manual.

4. Submit a Traffic Control Plan for review if the work involves a lane closure of more than four hours, however, all lane closures require traffic control in accordance with the TMUTCD.
 5. Prepare plans and specifications for the proposed work to be performed. If required, these plans should show the subject area and adjacent areas, the existing conditions, the proposed work, and any changes to the existing conditions.
 6. Adhere to the State of Texas, Underground Facility Damage Prevention and Safety Act. Prior to any excavation, the Dig Safely guidelines shall be followed, including calling a notification center in advance of excavation (Call-Before-You-Dig – 811).
- F. The applicant for the permit, his agent, or the contractor shall protect from damage, utility conduits, sewer conduits, water conduits, lawns, shrubbery, trees, fences, structures, or other property encountered in his work. The applicant shall not trespass upon private property. It is the applicant's responsibility to determine the boundary between public right-of-way and private property. Prior to entering upon private property, the applicant shall secure written permission from the property owner or owners affected.
- G. The applicant, his agent, or the contractor shall at all times insure the safety of the traveling public. He shall provide, install, and maintain traffic control devices as prescribed by the Texas Manual on Uniform Traffic Control Devices and when required, will also take such other measures of precaution as directed by the Department of Public Works. The Public Works Inspector will inspect all work locations for installations of traffic control devices. The Public Works Inspector has the authority to stop work if the traffic control does not conform to the requirements of the Texas Manual on Uniform Traffic Control Devices.
- H. The Department of Public Works shall inspect all work within the right of way of dedicated streets, dedicated drainage ways, or public easements. The Director of Public Works shall have the authority to revoke the permit whenever it is clear that the plans, details, and specifications are not being followed. All work and materials used shall be in accordance with the requirements of this manual and the City of Richmond Standard Details.
- I. Except in an emergency, no major thoroughfare or collector street shall be closed on weekdays during the hours of 6:30 AM to 9:00 AM and 4:30 PM to 7:00 PM without approval. Everyday of the week, all roadways shall be open to traffic by sunset on the same day as the construction. All lane closures require forty-eight (48) hour notification of the Police and Fire Departments prior to closing.
- J. Permittee shall dispose of all material removed from the ROW and any waste created by permittee in compliance with all state, federal and local laws and requirements. Temporary storage of material over 48 hours may be placed in a pile no higher than thirty inches (30”).
- K. Except in the case of an emergency, whenever excavation is required in the ROW adjacent to an occupied property, the ROW User shall notify the property owner of the activity through use of a door hanger, which shall include the following information:
1. Permit number.
 2. Identity of the Contractor and the ROW User, including a 24-hour emergency contact name and phone number and a phone number to obtain more information regarding the project.
 3. The anticipated duration of the construction work.

- L. Every permittee and ROW user shall prosecute its work diligently and in a good, safe, and workmanlike manner, and shall safeguard and protect the public, using the street or ROW where the work is being performed, from accidents or damage by placing barriers, lights and other sufficient safeguards around all cuts, openings and excavation. All material, implements and tools stored upon the premises and used in connection with the excavation shall be stored in a safe and non-hazardous manner.
- M. The City reserves its right, as provided herein, to revoke or suspend any permit, without refund of the permit fee, in the event of a breach by the permittee of the terms and/or conditions of the permit, this Manual and/or any other City ordinance. A breach of the terms of the permit shall include, but not be limited to any of the following:
 - 1. The violation of any provision of the permit.
 - 2. The failure to meet insurance, surety bond or indemnification requirements.
 - 3. The failure to complete the work as specified in the permit.
 - 4. The failure to correct a condition indicated on an order issued pursuant to City ordinances.
 - 5. Repeated traffic control violation.
 - 6. Failure to protect facilities or repair facilities damaged in the ROW.
 - 7. Any safety violation or other action that threatens the health, welfare and/or safety of the public as solely determined by the City.
- N. A permit shall only be valid for the area of the ROW specified within the permit. No permittee may cause any work to be done outside the area specified in the permit, except as provided herein. Any permittee who determines that an area is greater than that which is specified in the permit must apply for and receive a new ROW permit.
- O. After obtaining the permit and prior to commencing the work, the permittee shall notify the Department of Public Works of the “One-Call” ticket number and the date work will commence and complete all work within the time specified in the permit, unless an extension of time is granted by the City. No work shall commence until erosion control measures (e.g. silt fence) and advance warning signs, markers, cones and barricades are in place.
- P. Any request for a permit to excavate street pavement shall include a description of the proposed work and proposed restoration of the area, as well as a statement of clear and convincing evidence as to why alternate procedures cannot or should not be used in lieu of excavating a street. All pavement cuts and repairs shall be performed by a contractor with experience in street repair work and performed in accordance with the City of Richmond Repair Details and City specifications or, if unusual conditions are encountered, the City Engineer may require new standards for compaction, backfill and pavement restoration. Any damage to pavement outside the removal area shall also be repaired subject to approval of the Department of Public Works.
- Q. A permittee or ROW user shall maintain its repairs in the ROW for one (1) year from the completion date of any repair. In case the pavement or the surface of the street, alley, or ROW in, over or near any excavation should become depressed, cracked or broken at any time or fails in any way at any time after the excavation has been made and during the one (1) year warranty, the ROW User shall be responsible for repair of the failure.
- R. Open trenches may be temporarily backfilled for the convenience of the permittee or the public safety. Traffic bearing plates can be used temporarily for pavement areas.

- S. All excess water and mud shall be removed from the trench prior to backfilling. Any backfill placed during a rainy period or at other times, where excess water cannot be prevented from entering the trench, will be considered temporary and shall be removed as soon as weather permits. All disturbed base material or any base that has been undermined shall be removed and discarded. Compaction of all backfill shall be ninety five (95) percent of maximum density with a moisture content of 0% to +2% of optimum moisture content as determined by ASTM D698 under or near paved surfaces, future paved surfaces or otherwise as determined by the City. Backfill under and within one foot (1') of pavement shall be cement stabilized sand meeting City specifications.
- T. All earth, materials, sidewalk, pavement, utilities, conduits, crossing, irrigation, landscaping, monuments, manhole covers, valve covers, meter box lids or improvements of any kind, which are owned or possessed by the City, and damaged, disturbed, or removed by a ROW user shall be fully repaired promptly by the ROW user, at its sole expense, to the reasonable satisfaction of the ROW Manager.
- U. After any excavation, the ROW user shall, at its expense, restore the ROW, trench envelope, pavement structure and the surrounding area, to at least the same condition that it was prior to the excavation. The restoration shall be made in accordance with specifications set forth herein, and the repair shall endure without failure for one (1) year from the completion date of any repair.
- V. In the event the ROW user fails to restore the ROW in the manner and to the condition required herein, or fails to satisfactorily and/or timely complete all restoration, the City may, at its option, serve written notice upon the ROW user that, unless within five (5) business days after serving of such notice a satisfactory arrangement can be made for the proper restoration of the ROW by the ROW user, the City may take over the work and prosecute same to completion, by contract or otherwise, at the sole expense of the ROW user, and ROW user, and its surety, shall be liable to the City for any and all cost incurred by the City by reason of such prosecution and completion. Nothing contained herein shall limit any other remedies available to the City.
- W. If any excavation cannot be backfilled immediately, the ROW user shall securely and adequately cover the excavation and maintain proper barricades, safety fencing and/or lights as required, from the time of the opening of the excavation until the excavation is surfaced and opened for travel.
- X. No trench shall be opened in any paved area of the right-of-way for the purpose of laying pipes, conduits or ducts more than two hundred feet (200') in advance of the pipe, conduit or ducts being placed in the trench, other than with the prior written consent of the Director of Public Works. No trench shall be opened in any non-paved right-of-way for the purpose of laying pipes, conduits or ducts more than five hundred feet (500') in advance of the pipe, conduit or ducts being placed in the trench, other than with the prior written consent of the Director of Public Works. In all areas of the right-of-way, all trenches shall be closed prior to the end of the business day.
- Y. Before a permit shall be issued, the applicant shall execute and deliver to the City, to be kept on file with the City, a good and sufficient bond of performance or assurance in accordance with the requirements of Section 12.04.
- Z. Utility and other street crossings under pavement shall not be installed within 2 feet (2') of the bottom of the subgrade.

12.04 INSURANCE AND BONDING REQUIREMENTS

- A. A ROW user shall obtain and maintain insurance in the amounts reasonably prescribed by the City with an insurance company licensed to do business in the State of Texas. A person shall furnish the City with proof of insurance at the time of the request for permits. The City reserves the right to review the insurance requirements and to reasonably adjust insurance coverage and limits when the City Manager determines that changes in statutory law, court decisions, or the claims history of the industry or the person require adjustment of the coverage. For purposes of this section, the City will accept certificates of self-insurance issued by the State of Texas or letters written by the person in those instances where the State does not issue such letters, which provide the same coverage as required herein. However, for the City to accept such letters the ROW user must demonstrate by written information that it has adequate financial resources to be a self-insured entity as reasonably determined by the City, based on financial information requested by and furnished to the City. The City’s current insurance requirements are described below. If a certificate of insurance is on file from a previous application and has not expired, the valid certificate may be referenced on subsequent applications.

- B. The ROW user shall furnish, at no cost to the City, copies of certificates of insurance evidencing the coverage required by this chapter to the City. A ROW user shall immediately advise the City Attorney of actual or potential litigation that may develop may affect an existing carrier's obligation to defend and indemnify.

- C. An insurance certificate shall contain the following required provisions:
 - 1. Name the City of Richmond and its officers, employees, board members and elected representatives as additional insured for all applicable coverage;
 - 2. Provide for 30 days’ notice to the City for cancellation, non-renewal, or material change; and
 - 3. Provide that notice of claims shall be provided to the City Manager by certified mail or other approved by the City.
 - 4. The policy clause "Other Insurance" shall not apply to the City if the City is an insured under the policy.
 - 5. The permit applicant shall pay premiums and assessments. A company that issues an insurance policy has no recourse against the City for payment of a premium or assessment. Insurance policies obtained by a permit applicant must provide that the issuing company waives all right of recovery by way of subrogation against the City in connection with damage covered by the policy.

- D. The following insurance requirements shall be the minimum required for work within the public rights-of-way of Richmond.

	<u>TYPE</u>	<u>AMOUNT</u>
1.	Worker's Compensation	Statutory
	and	
	Employers Liability	\$100,000/500,000/100,000

2. Commercial General (public) Liability insurance including coverage for the following:
 - a. Premises operations
 - b. Independent contractors
 - c. Products/completed operations
 - d. Personal injury
 - e. Advertising injury
 - f. Contractual liability
 - g. Medical payments
 - h. Underground hazard*
 - i. Explosion and collapse hazard*
 - k. Fire legal liability*
 - l. City's property in Contractor's* care, custody, or control

* Optional, depending on the exposure of the contracted work.

Combined single limit for bodily injury and property damage of \$500,000 per occurrence or its equivalent.

3. Comprehensive Automobile Liability insurance, including coverage for loading and unloading hazards, for:
 - a. Owned/leased vehicles
 - b. Non-owned vehicles
 - c. Hired vehicles

Combined single limit for bodily injury and property damage of \$500,000 per occurrence or its equivalent

E. Before a permit shall be issued, the applicant shall execute and deliver to the City, to be kept on file with the City, a good and sufficient bond of performance or assurance, to be approved by the City and conditioned that the person making the application shall promptly adjust, pay and settle all legitimate claims for damages that may result by reason of carelessness or negligence in the manner of performing such work or by reason of any defects therein caused or arising from careless, negligent or imperfect construction thereof, and to hold the City, its council members, officers, employees, volunteers, agents, and representatives, free and harmless from liability on all such claims for damages to the performance or assurance bond which shall cover the cost of repairs in or upon the street, sidewalk or other public place where the work is to be done that may become necessary by reason of such cut or excavation having been made. The bond shall be maintained until the City accepts the work after the expiration of the one (1) year maintenance period. With respect to the ROW user's obligation to comply with the requirements for a performance/assurance bond, the City may allow the ROW user to self-insure such obligation upon production of evidence that is satisfactory to the City.

F. The amount of the required performance/assurance bond shall be as follows:

1. Work requiring street/sidewalk or pavement excavation or excavation within 5 feet (5') of pavement – 120% of the original construction cost

12.05 GRADING PERMITS

A. A grading permit is required to change the lines and grades of a parcel if more than 25% of the parcel is adjusted in elevation by greater than six inches (6”), if the flow of water onto or off of the site is impacted. Construction equipment may be stored at the site, but no construction

activity is allowed until a grading permit is obtained.

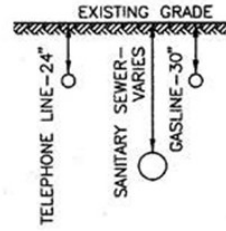
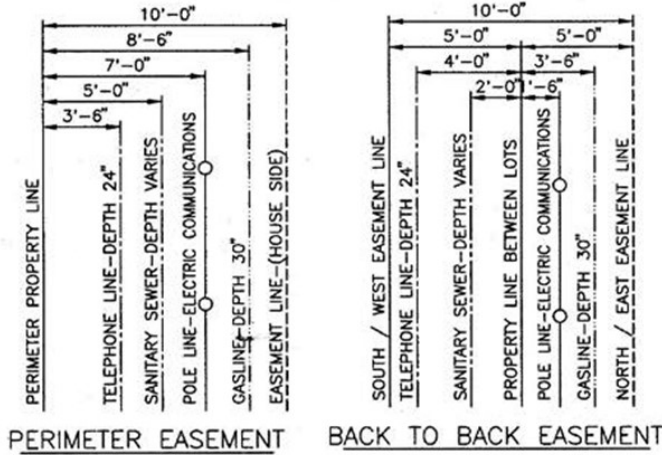
- B. A complete site plan including proposed paving, drainage facilities and grading shall be submitted for approval. Other pertinent information such as landscaping, parking areas, monument sign locations and driveways shall also be shown on the plans. Detailed information shall be provided which shows existing and proposed site elevations and drainage patterns. This information shall consist of contours, point elevations, grades, drainage arrows, slopes and cut/fill calculations in enough detail to demonstrate both existing conditions and the work intended to be performed.
- C. For grading plans that will increase or redirect drainage runoff, drainage calculations shall be provided and improvements made to allow no negative impact to off-site facilities.
- D. All finished grades shall be compacted to minimum of 95% standard proctor density. Adequate ground cover or re-vegetation shall be provided immediately. Alternately, a permanent silt fence shall remain in place and maintained until re-vegetation/re-growth takes place.
- E. All plans and calculations shall be prepared and sealed by a Texas Registered Professional Engineer.
- F. Permit requests should be submitted to the Permitting Department with the correct fee for plan review. The fee is based on the valuation of work to be performed, in accordance the latest adopted fee schedule.
- G. The contractor and/or property owner is responsible for complying and coordinating with all other applicable local, state and federal regulations, including but not limited to the city's adopted storm water management ordinance.

12.06 PUBLIC AND PRIVATE UTILITY LOCATIONS

- A. New installations of public and private utilities (i.e. CATV, telephone, gas, etc.) within the right-of-way shall not be located within four feet (4') of the back of curb on curb-and-gutter streets unless they are three feet (3') or greater below grade nor between the edge of pavement and the roadside ditch on open ditch streets. New installations are defined as utilities installed after December 31, 2003.
- B. The minimum horizontal and vertical separation between private utilities and any public utility shall be eighteen inches (18").
- C. The location of jack and bore pits shall be shown on permit applications. Jack and bore pits shall be at least three feet (3') from the back or curb or edge of pavement.
- D. Public and private utility depths within the public right-of-way shall not be less than the utility depths requirements of the Typical Easement Installation Details shown below.
- E. Public and private utilities along open ditch roadways shall be installed in utility easements adjacent to the public right-of-way when the easements are available. Franchise utilities along open ditch roadways shall not be less than two feet (2') below the flow line of any ditch under any circumstances and, wherever possible, shall be installed between the outside bank of the ditch and the right-of-way line.

- F. Public and private utilities crossing under street pavement shall not be installed within two feet (2') of the bottom of the subgrade.
- G. Public and private utilities in easements shall be installed in accordance with the Typical Easement Installation Details shown below. Rear lot easements that do not include sanitary sewers may be reduced in width to fourteen feet (14').

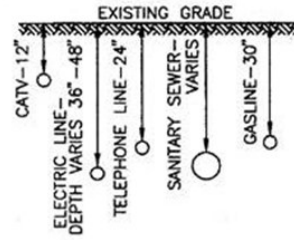
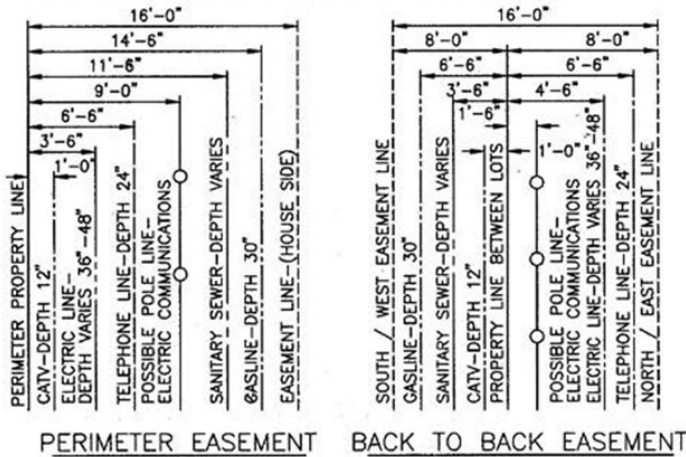
TEN-FOOT (10') WIDE EASEMENT



TYPICAL INSTALLATION DEPTHS

UTILITIES ARE NORMALLY INSTALLED AS SHOWN BUT DEPTH MAY VARY DUE TO CUT BY OTHERS. MAINTAIN MINIMUM 4" CLEARANCE BETWEEN ALL UTILITY LINES EXTENDING FROM EASEMENT TO HOUSE/BUILDING.

SIXTEEN-FOOT (16') WIDE EASEMENT




TYPICAL INSTALLATION DEPTHS

UTILITIES ARE NORMALLY INSTALLED AS SHOWN BUT DEPTH MAY VARY DUE TO CUT BY OTHERS. MAINTAIN MINIMUM 4" CLEARANCE BETWEEN ALL UTILITY LINES EXTENDING FROM EASEMENT TO HOUSE/BUILDING.

NOTES:

1. NO PRIVATE FRANCHISE UTILITIES (I.E., PHONE, CABLE T.V., ELECTRICITY, ETC.) SHALL BE INSTALLED WITHIN 4 FEET BACK OF CURB.
2. REFER TO GENERAL NOTES

 CITY OF RICHMOND DEPARTMENT OF PUBLIC WORKS	
TYPICAL EASEMENT INSTALLATION DETAILS (NOT TO SCALE)	
APPROVED BY:	APPROVED BY:
SCOTT R. ELMER, P.E. CITY ENGINEER	DAVID L. "LEE" DORGER DIRECTOR OF PUBLIC WORKS
EFF DATE:	DWG NO:

END OF CHAPTER



City of Richmond

Design Manual

Chapter 13

QUALITY CONTROL & CONSTRUCTION MATERIAL TESTING REQUIREMENTS

CHAPTER 13

QUALITY CONTROL & CONSTRUCTION MATERIAL TESTING REQUIREMENTS

13.01 GENERAL

- A. These standards describe the general requirements for construction material testing on all public projects within the city limits and extra-territorial jurisdiction of the City of Richmond.
- B. The Richmond Public Works Department shall approve construction plans and construction material testing plans for public improvements within the Richmond city limits or extraterritorial jurisdiction.
- C. Construction plans for private improvements, within public right-of-ways and public easements that connect to or affect the public infrastructure shall be approved by the City of Richmond subject to the requirements of this manual and are subject to review and approval using the process defined in this manual.
- D. Public projects are defined as projects that are within public rights-of-way or public easements, projects that will be owned, operated or maintained by public agencies or projects that are funded by public agencies.
- E. It is the responsibility of the contractor to deliver a finished product in compliance with the contract documents and applicable Federal, State and local requirements. An independent testing laboratory shall be utilized to verify contract document compliance.
- F. The contractor is responsible for notification of the City and the independent testing laboratory in accordance with the City's notification requirements. In the event construction activity occurs without proper notification to the City, the work in question is subject to removal and replacement in accordance with these Standards at the discretion of the City Engineer.
- G. The Department of Public Works shall develop and maintain an Approved Products List. All material and appurtenances used in construction in public right-of-ways and easements shall conform to the Approved Products List.

13.02 REFERENCES AND REQUIREMENTS

- A. All construction material testing shall be performed by an independent testing laboratory, certified by the appropriate agency for the field of testing being conducted and supervised by a Texas Professional Engineer. All testing shall be performed in accordance with generally accepted standards, including:
 - 1. Rules and Regulations published by the Texas Commission on Environmental Quality (TCEQ).
 - 2. American Society of Testing Materials (ASTM)

3. American Concrete Institute (ACI)
 4. The Asphalt Institute
 5. Texas Department of Transportation Standard Specifications
- B. Testing laboratories shall be hired by the project owner or project engineer and contracts shall avoid conflicts of interest.
 - C. City projects – The costs of initial tests may be borne by the City or may be a part of the construction contract. When initial tests indicate noncompliance with the contract documents, the cost of subsequent retesting shall be borne by the contractor. The costs of inspections or testing performed exclusively for the contractor's convenience or information shall be borne by the contractor.
 - D. The City shall be copied on all testing reports for public projects. Testing reports shall be completed and submitted to the City in a timely manner and signed by a Texas Professional Engineer.
 - E. It is the responsibility of the contractor to provide proper and timely notification of construction activity to both the testing laboratory and the City.
 - F. All retests of failed densities shall be taken within five linear feet (5') of the failed test.
 - G. Moisture content on all soil density tests shall be within plus or minus two percent (2%) to achieve a passing test, unless approval is granted by the City Engineer based upon site-specific testing.
 - H. Independent testing laboratories are not authorized to revoke, modify, or release any requirement of the specifications and they may not approve or accept any portion of work on a project. When it appears that the material furnished or work performed fails to meet the contract document requirements, the testing laboratory shall promptly inform the City, in writing, of such deficiencies.

13.03 PAVEMENT SUBGRADE

- A. Pavement subgrade shall be a minimum of eight inches (8") thick and shall be within 0.2 inches (0.2") of final lines and grade and shall vary uniformly between points. Subgrade stabilization and compaction shall extend a minimum of two feet (2') beyond the back-of-curb or edge of pavement. All subgrade shall be compacted to a minimum of 95% of the maximum dry density of the material as determined by Standard Proctor Compaction Test ASTM D-698. Moisture content on all density tests shall be within plus or minus two (2%) percent of optimum moisture to achieve a passing test.
- B. Subgrade density tests are required at a longitudinal spacing of every 150 linear feet, (150') staggered across both lanes of traffic, on pavement cast full width on undivided roadways. Density tests shall include the entire cross-section of the subgrade, including the area two feet (2') outside of the form boards. For pavement cast half-width, density tests are required every 300 linear feet (300') for each half of the roadway, with the tests offset from tests in the adjacent half of pavement by 150 linear feet (150'). Regardless of any other requirement, all cul-de-sacs shall

have a minimum of one (1) density test within the cul-de-sac.

- C. Lime depth checks are required for all pavement subgrades at the same spacing and frequency requirement as density tests.
- D. Lime determination shall be made utilizing a soil proctor from the site. Subgrade shall be stabilized to a minimum eight inches (8") thick to reduce Plasticity Index (PI) to fifteen (15) as determined by lime series. If a PI of 15 or less cannot be obtained, then the lime treated soils must obtain a pH of 12.4, must be increased to eight inches (8") thick and compacted to ninety-five percent (95%) standard proctor density. Add one-percent (1%) for field variation. Lime subgrade shall be mixed evenly and allowed 48 hours between mixing to cure. Remixed lime shall have 100% of the representative sample passing a 1¾" sieve, 100% of the sample passing a 1" sieve, 85% of the sample passing a ¾" sieve, and 60% passing the No. 4 sieve.
- E. Lime operations shall not occur if the ambient temperature is 40 degrees Fahrenheit and falling. Lime operations may occur if the ambient temperature is 35 degrees Fahrenheit and rising.
- F. Subgrade densities shall be retaken in the event of a 1 inch (1") or greater rainfall or in the event the ambient air temperature falls below 32 degrees Fahrenheit for greater than three hours.
- G. Subgrade density testing shall occur after the subgrade has been cut to final lines and grade. No subgrade/earthen material may be placed on the subgrade after passing density tests have been achieved. Form shall be set to grade before testing.
- H. Prior to the application of lime slurry the roadbed shall be excavated to subgrade, shaped to conform to the typical sections, lines and grades as shown on plans. The material, before lime is added, shall be scarified to the secondary grade (proposed bottom of the lime stabilized subgrade). A "proof roll" shall be performed prior to the application of lime slurry to identify any wet or unstable materials. Any wet or unstable materials below the secondary grade shall be corrected, by scarifying, adding lime and compacting until it is of uniform quality. The results of the proof roll and any correcting action shall be documented by the testing laboratory.

13.04 CONCRETE PAVEMENT AND UTILITY CONSTRUCTION CONCRETE

- A. All concrete mix designs shall be approved by both the independent testing laboratory and the City prior to the placement of concrete on any project. No fly ash allowed.
- B. Concrete operations shall not occur if the ambient temperature is 40 degrees Fahrenheit and falling. Concrete operations may occur if the ambient temperature is 35 degrees Fahrenheit and rising.
- C. Concrete shall be tested every 125 cubic yards or less of concrete that is placed each day. Test shall be conducted for the following criteria:
 - 1. Entrained air – Not to exceed five percent (5%). If air and water reducer is not added, no concrete shall be placed after sixty (60) minutes of batch time. If air and water reducer is added, concrete cannot be poured after ninety (90) minutes.
 - 2. Slump – Between two and one-half inches (2 1/2") and five inches (5")
 - 3. Concrete Temperature – Not to exceed 95 degrees Fahrenheit.

4. Cylinders – A minimum of one set of four cylinders to be tested for compressive strength.
- D. Hand manipulated mechanical vibrators shall be used for proper consolidation of concrete in all pavement areas. This is in addition to a vibrating screed.
 - E. Finished pavement shall have core samples taken every 750 linear feet (750'), staggered across the roadway cross-section, and in every cul-de-sac. Additional core samples may be required at the discretion of the City Engineer. These core samples shall be tested to insure that the pavement thickness meets the required project thickness.
 - F. Concrete cylinders, taken at the time of placement, shall be the standard for testing for compressive strength. In limited, unique circumstances, concrete cores of the finished pavement may be tested for compressive strength, with prior approval by the City Engineer. In the event that concrete cores are approved for testing, the pavement shall meet the required compressive strength without consideration of an allowance for cut cores or any other reduction in strength allowance.
 - G. Pavement shall meet both the minimum compressive strength and the minimum thickness requirements prior to acceptance by the City of Richmond. Pavement that fails to meet both requirements shall be removed and replaced prior to acceptance by the City.
 - H. In the event that pavement thickness requirements are not met, the limits of the short pavement shall be identified through the use of additional cores at ten foot (10') spacing on each side of the deficient pavement until the minimum thickness requirement is met.
 - I. In the event a variance for deficient pavement thickness is considered by the City, the City shall consider the extent of the thickness deficiency in area and thickness, the concrete compressive strength, the thickness of the subgrade, the performance of the remainder of the pavement on the project and the performance history of the contractor on the project when reviewing the variance. In addition, the impact of the deficient pavement on the City's long-term maintenance costs shall be considered.
 1. Accepted pavement deficient in thickness between 0.00" and 0.1" shall be considered without a maintenance fund payment based upon the recommendation of the design engineer, the extent and location of the deficient pavement, verification of subgrade and other relevant specifications being met and other relevant factors.
 2. Pavement deficient in thickness between 0.11" and 0.20" shall require a maintenance fund payment to the City of 25% of the contract unit price times the area of deficient thickness pavement.
 3. Control joints shall be placed at 20' (twenty feet) C-C.
 4. Pavement deficient in thickness between 0.21" and 0.25" shall require a maintenance fund payment to the City of 50% of the contract unit price times the area of deficient thickness pavement.
 5. Pavement deficient in thickness greater than 0.25" shall not be considered for acceptance.
 - J. Finished pavement shall be burlap drag mounted on a work bridge or moveable support system and in conformance with TXDOT item 360.3.D.1, and provide equipment capable of providing a fine light water fog mist. Pavements that are excessively smooth or rough shall be subject to

removal and replacement.

- K. Finished streets shall positively drain and be free from areas of standing water (birdbaths) within 12 hours after water has ceased to flow by gravity. Street subject to acceptance by the City for City maintenance shall be flooded with sufficient water along the gutter line to identify potential birdbaths prior to acceptance into the one year maintenance period. Pavement scarifying or grinding is not allowed to remediate “birdbaths” on newly constructed pavement.
- L. All concrete placed shall be uniformly sprayed with a membrane curing compound as described in Item 526 in the TxDOT standard specification for construction. Improper application will result in rejection of the concrete.

13.05 ASPHALTIC CONCRETE PAVEMENT

- A. Stabilized base courses shall be compacted under the controlled density method. The base courses shall be compacted to not less than 95% of that density obtained in Test Method Tex-114-E of the Texas Department of Transportation testing procedures using a compactive effort of 13.26 Ft-lbs per cubic inch.
- B. All asphalt riding surface and base course density tests shall be taken a minimum of once every 250 square yards or once for every 300 linear feet (300') of driving lane, whichever may apply. Testing of multiple lanes shall be staggered.
- C. Finished base course grades shall not deviate more than ¼-inch in sixteen feet (16') from the designated grade line.
- D. Asphaltic base courses shall be installed in maximum lifts of four inches (4"). Asphalt riding surfaces shall be placed in maximum lifts of two inches (2"). Densities shall be taken on each lift prior to placement of subsequent lifts.
- E. Hot mix asphaltic materials, shall be at temperatures between 250 degrees Fahrenheit and 325 degrees Fahrenheit when laid. This shall be verified by tests. Compaction shall begin while the material is still hot and as soon as it will bear the weight of the roller/compactor without undue displacement or hairline cracking.
- F. All asphalt roadway materials may not be placed in wet conditions or if the ambient temperature is below 50 degrees Fahrenheit and falling. Material may be placed if the ambient temperature, taken in the shade, is 40 degrees Fahrenheit and rising.
- G. Asphaltic materials and base courses adjacent to existing asphalt roadways shall be placed against clean, straight edges. It is the responsibility of the contractor to saw cut, full-depth to establish this edge, if necessary.
- H. Finished pavement shall have core samples taken every 750 linear feet, staggered across the roadway cross-section, and in every cul-de-sac. Additional core samples may be required at the discretion of the City Engineer. This core samples shall be tested to insure that the pavement thickness meets the required project thickness.

13.06 CEMENT STABILIZED SAND

- A. All cement stabilized sand shall be a minimum of 2.0 sacks cement per ton sand. Cement stabilized sand shall comply with ASTM C31. Cement stabilized sand shall achieve a minimum of 100 PSI compressive strength at 48 hours from placement. All cement stabilized sand used for backfill or subgrade shall be compacted to a minimum of 95% of the maximum dry density of the material as determined by Standard Proctor Compaction Test ASTM D-698.
- B. Cement stabilized sand shall be placed and compacted within four (4) hours of batching.
- C. A minimum of two (2) random samples for compressive strength shall be taken each week. For smaller projects, one sample may suffice with City approval. The City of Richmond reserves the right to require additional tests, at the contractor's expense, if it is deemed necessary. In the event of a change in supplier, samples shall be drawn on the first day of delivery from the new supplier, regardless of previous samples taken.
- D. Cement stabilized sand samples shall be taken at the point of placement of the cement stabilized sand and identified as to the location of the sample.
- E. Cement stabilized sand densities shall be taken a minimum of every 150 linear feet of trench, with a minimum of two (2) tests (one per direction of travel) at each road crossing. When utilized as subgrade on roadway repairs, density tests shall be taken every 100 square feet of subgrade, with a minimum of one (1) test per repair.
- F. Cement stabilized sand shall not be placed in loose lifts greater than eight inches (8") and shall be compacted to 95% of the maximum dry density of the material as determined by Standard Proctor Compaction Test ASTM D-698. Moisture content on all density tests shall be within plus or minus two percent (2%) of optimum moisture to achieve a passing test.

13.07 BEDDING, BACKFILL, EMBANKMENTS AND LOT FILL

- A. No bedding, backfill, embankment or lot fill shall be placed in loose lifts exceeding eight inches (8") in thickness without prior, written approval of the City Engineer.
- B. All trench backfill and lot fill, regardless of material, shall be compacted to 95% of the maximum dry density of the material as determined by Standard Proctor Compaction Test ASTM D-698. Moisture content on all density tests shall be within plus or minus two (2%) percent of optimum moisture to achieve a passing test. Test frequency will be required as follows.
 - 1. Bedding and density tests shall be performed a minimum of every 300 linear feet (300') of trench in each lift. Density tests shall be offset on alternating lifts and tests locations shall be identified by station number.
 - 2. Embankments shall be tested at intervals not to exceed 300 linear feet (300') of roadway and/or as conditions may require in each lift.
 - 3. All lots shall be proof-rolled and a minimum of one density test shall occur on all lots on which fill operations have occurred. The city reserves the right to require additional, certified density testing.

13.08 UTILITY CONSTRUCTION

- A. Utility construction shall be tested in accordance with the requirements of this chapter, the appropriate utility construction chapter and the Richmond Standard Construction Details, as well as the requirements of any other agency having jurisdiction.
- B. The City reserves the right to require that any storm, sanitary or water utility line be inspected by video, and a copy of the video be submitted to the City, prior to acceptance by the City.

END OF CHAPTER



City of Richmond

Design Manual

Chapter 14

PUBLIC WATER PLANT REQUIREMENTS

CHAPTER 14

PUBLIC WATER PLANT REQUIREMENTS

14.01 GENERAL

- A. These standards describe the general requirements for public water supply wells and water plants.
- B. The Richmond Public Works Department shall approve construction plans for all public improvements within the Richmond city limits or extraterritorial jurisdiction.
- C. Construction plans for private improvements, within public right-of-ways and public easements that connect to or affect the public infrastructure shall be approved by the City of Richmond subject to the requirements of this manual and are subject to review and approval using the process defined in this manual.
- D. Public water wells and water plants shall be owned and operated by either the City of Richmond or a municipal utility district approved by the City.

14.02 SITE REQUIREMENTS

- A. Properties for water plant, well, and tank sites shall be conveyed in fee to the City of Richmond or the approved municipal utility district.
- B. Sites shall meet at least one of the following conditions for access:
 - 1. Have 60 feet or more of frontage directly on at least one public street having a right-of-way width not less than 50 feet.
 - 2. Have at least a 60-foot-wide fee strip access from a public street having a right-of-way width not less than 50 feet.
- C. A one hundred-fifty foot (150') radius well sanitary control easement, three hundred foot (300') radius to any sewage wet well or pumping station and five hundred foot (500') radius to any sewage treatment plant, approved by the Texas Commission on Environmental Quality, are required.
- D. The minimum site size for a well-only site shall be 5,000 square feet and must be of a size and shape such that all facilities and appurtenances are located wholly within the site and allow for proper maintenance of such facilities. Should the site require infrastructure in addition to the well, the site shall be of a size and shape such that all necessary wells, equipment, appurtenances and zoning buffers are located wholly within the site.
- E. Access Road:
 - 1. Provide an all-weather road of not less than 12 feet (12') in width to the site.
 - 2. Inside the site, an all-weather surface shall be provided for reasonable access to wells, booster pumps, chlorine rooms, fuel tanks, and other areas requiring proximate vehicle

access.

F. Internal Site Horizontal Spacing:

1. Wells:

- a. Locate wells a minimum of 40 feet from the site boundary at the point of access. Provide 60 feet by 40 feet of open area on one quadrant of the well for laying out drill pipe during well repair.
- b. No site boundary, public street right-of-way, utility easement, or power company aerial easement shall encroach within the well site.
- c. With the exception of well discharge piping, splash pads, and auxiliary power with ancillary facilities, all plant equipment, fences, plant structures, and aboveground piping shall be at least 30 feet from wells.
- d. Where space permits, locate well discharge piping and auxiliary power at right angles to the direction of well access.

2. Elevated Storage Tanks:

- a. No site boundary, public street right-of-way, utility easement, or power company aerial easement shall be within the elevated tank site.

3. Ground Storage Tanks:

- a. Locate ground storage tanks a minimum of 20 feet from any site boundary, public street right-of-way, utility easement, or power company aerial easement. Aerial easement shall not encroach on the storage tank site.
- b. Locate ground storage tanks a minimum of 20 feet from plant structures and equipment.
- c. Provide at least 10 feet of clearance between ground storage tanks and centerline of plant piping, except where segments of piping are routed directly to the tank.

4. Yard Piping:

- a. Underground yard piping larger than 6 inches shall be separated at least 4 feet between nominal outside diameters.
- b. Provide a minimum of 3 feet (3') of clearance for above-ground yard piping to include all flanges, valves, activators, supports, and appurtenances.
- c. Centerline of yard piping shall be a minimum of 6 feet from site boundaries and utility easements.
- d. Locate underground yard piping so that thrust blocking or restraints, if any, will be located wholly within the site boundary and does not encroach upon an easement outside the site boundary. Encroachment upon access fee strips is permitted.

G. All water plant sites shall be fenced in accordance with the City of Richmond Zoning Ordinance Requirements. Fencing shall be located on the property line. All gates shall have a minimum

clear opening of 25 feet in width.

H. Grading and Drainage:

1. Use drainage swales, sidewalks and driveways, culverts, storm sewers, or a combination thereof for internal site drainage.
2. If an offsite storm sewer or major drainage channel is available, site drainage shall be collected into an internal storm sewer system before leaving the site.
3. Internal storm sewer system shall be sized for site drainage and shall have capacity for water well blow off, tank overflow, and drainage.
4. All unsurfaced areas on the site and access strip shall be seeded and fertilized or hydro-mulched.

14.03 WATER WELL REQUIREMENTS

A. Water wells shall be designed to operate automatically without requiring direct operator control. Equip wells with controls to allow for manual operation.

B. Secure applicable subsidence agency and state regulatory permits and conduct an environmental site assessment for the proposed site prior to drilling well.

C. Domestic wells shall be gravel packed.

D. Water Well Location:

1. A 1,000 gallon per minute (gpm) or larger well shall be a minimum of 2,000 feet from another 1,000 gpm or larger well which is screened in the same aquifer. No minimum separation is required if the wells are in different aquifers.
2. Whenever possible, do not drill a new public water supply well on the perimeter of the development it is to serve.

E. Sizing:

1. Minimum well size is generally 1,000 gpm. The casing and liner (interior casing) diameters shall be sized to allow the pump to be lowered into the liner based on the manufacturer's minimum clearances between the pump and the liner. Engineer shall demonstrate that sufficient piezometric head is available above the casing/screening lap to allow for lowering the pump to a sufficient depth to provide capacity for a twenty year period based on the most current available 10-year draw down data from the Fort Bend County Subsidence District.
2. Water wells with capacities of less than 1,000 gpm shall be reviewed on an individual basis. Review will include type of construction, pumping equipment, liner sizes, demand, aquifer yield, water quality, etc. Minimum sizing shall be based upon the required fire flow plus 25%.

F. Piping:

1. Design piping so that the well will discharge directly to ground or elevated storage tanks, if provided.

2. The well may have a direct pipe connection, including disinfection, into the distribution system. Design this direct connection to allow emergency operation of the well independent of booster pumps, ground storage tanks, or pressure tanks. The well and disinfection system shall be designed to operate under such conditions.
3. Size the pump column pipe to provide a minimum velocity of 4 feet per second to raise any sand to the surface.
4. Aboveground piping:
 - a. The well discharge piping shall be sized for proper operation of the check valve and water meter. Normal velocities should be 4 to 8 feet per second.
 - b. Provide a sample tap and an air release valve.
 - c. Provide a water level sounding pipe attached to the piping to allow for the checking of the static water levels. The pipe shall be a minimum of one inch (1") pipe with holes/slots to allow for water to get in. Pipe shall terminate above ground with a removable cap for testing.
 - d. Provide a pressure gauge between the check valve and flowmeter.
 - e. Provide 10 pipe diameters of straight pipe leading into the water meter and a minimum of 2 pipe diameters of straight pipe downstream of the water meter or install in accordance with meter manufacturer's recommendations, whichever is greater.
 - f. The well blow-off shall be installed downstream of the flowmeter.
5. Where a well is capable of pumping directly into the distribution system, a minimum chlorine contact time of 20 minutes shall be achieved by one of the following:
 - a. Use of line storage before the first user is tapped onto the line.
 - b. Use of a hydro-pneumatic tank.

G. Pumps:

1. Pumps may be either line shaft turbine or submersible. Pumps with voltage greater than 480 volts will be line shaft turbine.
2. A pump may be installed in a well that has a design capacity greater than the rated capacity of the pump.
3. The pump should have adequate submergence to allow a pumping level decline for approximately seven years based on historic regional decline in the area.

H. Motors:

1. Size electric motors to carry the full load of the well pump without using motor service factor. Provide control wiring lockout at well head.
2. Motor to be totally enclosed fan cooled.
3. The minimum efficiency of submersible pumps shall be 80% percent with 85% efficiency desirable. The minimum efficiency of above grade well motors shall be 95% efficiency.
4. Provide an anti-reverse ratchet and timer lockout for all vertical turbine pumps. Should the ratchet fail during normal operation, the motor will not start until reverse rotation has stopped. The timer lockout shall provide for two delays in series. Controls shall be in

installed to prevent pump against a dead head.

5. In all cases, provide a timer on the well motor start circuit to prevent starting of the well within 300 seconds of shutdown.
6. Motors should be selected to allow compliance or modification for compliance with the City of Richmond Noise Ordinance.
7. Space heating required for motors.

I. Construction:

1. If excavated mud pits are used, they shall:
 - a. Include an impervious, synthetic lining on the bottom and sides of the pits.
 - b. Provide drainage so that run-off from the pits does not reach the water well.
 - c. Be cleaned out after drilling the well and filled to grade with a fill material approved by the Engineer.
2. Testing is to be performed as follows:
 - a. Run an Eastman Inclination Survey in the test hole and reamed hole.
 - b. Run an Electric Induction Log in the test hole.
 - c. Run a Compensated Density Neutron Log, with gamma radiation shown, in the test hole.
 - d. Run a Spectra-Log in the test hole to determine if harmful radiation exists where a strong gamma-ray signal appears on a Compensated Density Neutron Log, or where known radiation problems exist within the water production zone.
3. All efforts shall be made to reach a minimum specific capacity of 25 gallons-per-minute-per-foot of drawdown after 12 hours of continuous well operation.
4. Provide a groundwater elevation monitoring system using a continuous plastic-coated stainless steel air line run to 5 feet (5') above the pump bowls or other method allowed in the latest revision of AWWA A100.
5. Extend the well liner a minimum of 20 feet below the bottom screen.
6. The minimum lap between casing and liner is 75 feet.

J. Address the following in the specifications:

1. Size, wall thickness (minimum 0.5 inch), and planned length of casing and blank liner.
2. Size, location, material, and anticipated length of screens.
3. Test hole procedures including diameter, depth, and required tests.
4. Cementing procedures.
5. Gravel pack material and method of placement.

6. Test pumping equipment.
7. Development procedures.
8. Disinfection, bacteriological, and chemical testing procedures.
9. Capping procedures.
10. Pump details including capacity, component materials, setting, and column size.
11. Procedures to follow if the test hole or well is to be abandoned.

14.04 BOOSTER PUMPS

- A. The minimum booster pump sizes shall be based upon:
 1. Minimum combined pump and motor efficiency shall not be less than 75 percent.
 2. Pumps shall be installed in combinations that will allow for flexibility of operations. Options include:
 - a. The use of a small capacity "jockey" pump for low demand situations to minimize wear on larger pump starting equipment.
 - b. The use of controls that allow alternate operation.
 - c. Other pumps sized as required to meet actual design flows and pressures required.
 - d. The use of variable speed pumps and equipment.
 3. Pumps of the same location should be designed for the same discharge pressure.
- B. The following types of pumps are acceptable:
 1. Horizontal split case centrifugal.
 2. Vertical turbine ("can") pumps.
- C. Operations:
 1. Pump speed shall not be greater than 1,800 rpm.
 2. Minimum rated design discharge pressure shall be 60 psi.
 3. Pump operation shall be controlled by pressure differentials as a function of system demand. Pressure sensing shall be in accordance with Chapter 6 of these Guidelines.
 4. Booster pumps shall be locked out of operation by activation of ground storage tank low-level cut-off alarm circuit.
- D. Motors:
 1. Electric motors under 300 horsepower shall be 3-phase, 460-volt operation. Motors 300 horsepower and larger may operate at higher voltages. Booster pumps at a plant shall be three phase and shall operate at the same voltage as the other booster pumps.
 2. Size electric motors to accommodate the maximum design-operating load of the booster

- pump without using motor service factor.
3. Service factor on motors shall be 1.15 minimum.
 4. Motor enclosures may be open drip-proof if inside a building, WP-1, or totally enclosed fan cooled.
 5. It is recommended that motors 75 horsepower or greater have reduced voltage, auto-transformer starting, 65 percent tap. The use of Variable Frequency Drives for the motors is also allowed.
 6. Minimum efficiency of electric motors to be 95 percent.
 7. Include space heaters on motors that are not located within buildings.

14.05 HEADERS AND YARD PIPING

A. Ductile Iron Pipe:

1. Ductile Iron Pipe:
 - a. Centrifugally cast in molds.
 - b. Minimum Thickness Class:
 - (1) Class 350 for all locations.
2. Ductile Iron Pipe Fittings:
 - a. Flanges drilled for Class 125 in accordance with ANSI B16.1 may be used for operating pressures to 250 psi. For operating pressures exceeding 250 psi, provide ANSI B16.1, Class 250 flanges.
 - b. Exposed service fittings to be flanged and buried service fittings to be mechanical joints with restraints at fittings and valves.
3. Nuts and bolts: Stainless steel 316.
4. Gaskets: Grade 1 (rubber).
5. Internal Coatings: Cement mortar, epoxy coated (NSF 61 approved) or as approved by the City Engineer.
6. External Coatings:
 - a. Exposed service: Epoxy/polyurethane paint system.
 - b. Buried service: Coal tar coated and polyethylene encased; hot applied coal tar tape coating; or cold-applied tape coating system.

B. Velocities:

1. Suction Headers:
 - a. Flow velocity in suction piping, before any reducers, shall not exceed 6 feet per second.
 - b. Flow velocity in suction headers shall not exceed 6 feet per second.

2. Discharge Headers:
 - a. Flow velocity in discharge piping shall not exceed 8 feet per second.
 - b. Flow velocity in discharge header shall not exceed 8 feet per second.
3. Yard piping: Velocity in yard piping shall not be less than 2 feet per second or more than 8 feet per second.
4. Calculate velocities assuming both suction feeds are open and both distribution lines are open from the discharge header (i.e., one-half of total flow in each direction).
5. Do not include the capacity of stand-by pumps in the calculation of peak flow maximum velocities.
6. For well discharge lines, see Section 15.03, Water Wells.

C. Anchorage and Blocking:

1. Provide reaction blocking, anchors, restrained joints, or other acceptable means for preventing movement of piping caused by forces in or on buried piping tees, wye branches, plugs, or bends. Refer to Standard Details.
2. Place concrete blocking so that it extends from fitting into solid undisturbed earth wall. Concrete blocks shall not cover pipe joints or bolts. All fittings shall be wrapped in polyethylene.

D. Suction and Discharge Headers:

1. Headers located next to walls or structures shall be a minimum of 3 feet to the outside of the pipe from such walls, structures, to allow for access to valves and fittings.
2. Provide adequate space and access between headers, piping, pumps and motors to allow proper clearances and access for maintenance and repair. Specific requirements will depend upon actual physical layout and sizes of components.
3. A single line from the well or storage tank shall supply the suction header. The suction headers shall end with a blind flange to allow for future expansion. Provide shut-off valves to allow for isolation of the pumps from the suction header.
4. A single discharge header shall feed the distribution system. Provide shut-off valves to allow for isolation of the pumps and check valves from the discharge header. The discharge header shall start with a blind flange to allow for expansion and end with a connection to the distribution system.
5. Suction piping from the suction header to pump suction nozzles shall be as short and direct as possible and should be larger in diameter than pump suction nozzles to minimize suction head loss. Reducers used in suction piping shall be eccentric reducers installed with the flat side on top to reduce air pockets trapped in the suction lines.
6. Pump suction piping should be as straight as practical. Avoid placing 90- degree bends directly in front of pump suction and discharge nozzles.

E. Suction and Discharge Header Valves:

1. Provide shut-off valves on suction piping and discharge piping of each pump for isolation

from headers.

2. Provide a slow closing check valve or other control valve on discharge pipe of each pump between the pump and the shut-off valve to limit reverse flow from the pressure system into the ground storage tank when the pump stops.
3. Use check valves with controlled rate of closure as may be needed to reduce water hammer potential on discharge piping. (See Approved Products).

F. Yard Piping:

1. Clearance between waterlines and sanitary sewers shall conform to requirements set forth for water distribution systems in the "Rules and Regulations" for Public Water Systems published by the TCEQ.
2. Locate yard piping in areas easily accessible for maintenance.
3. Yard piping shall connect with distribution system lines and a feed to the hydro-pneumatic tanks, if supplied.
4. Yard piping shall be considered to end at the point of connection to the distribution system line.
5. Standard sizes noted in AWWA Standards may be used except 10-inch and 14-inch unless already in place.
6. Between discharge header and distribution system, provide a water meter. Provide 10 pipe diameters of straight pipe leading into the water meter and a minimum of 2 pipe diameters of straight pipe downstream of the water meter or install in accordance with meter manufacturer's recommendations, whichever is greater. If below grade, provide a vault for the meter.

G. Yard Piping Valves:

1. Install valves in a manner that will allow easy access and operation.
2. Valves installed below ground shall have valve boxes and shall be located outside paved areas and other areas normally traveled by vehicles.
3. Size and type:
 - a. Gate valves shall be used for 2-inch through 16-inch diameters.
 - b. Use butterfly valves on lines 18 inches and larger in diameter, unless otherwise directed by City Engineer.

H. Testing Requirements:

1. Test piping systems upon completion of piping and prior to application of insulation on exposed piping or covering concealed or buried piping.
2. Isolate equipment that may be damaged by the specified pressure test conditions.
3. Perform pressure test using calibrated pressure gauges and calibrated volumetric measuring equipment to determine leakage rates.
4. Completely assemble and test new piping systems prior to connection to existing pipe

systems.

5. Test pipe at 1.5 times the maximum working pressure or 125 psi, whichever is greater.

14.06 BOOSTER PUMP BUILDINGS

A. General:

1. All buildings plans shall be submitted to the City of Richmond Development Services Department for review and approval. A permit will be issued once all comments are addressed and fees paid.
2. Do not put chlorination equipment or store chlorine bottles in the same room as pumps, motors, and electrical equipment. Provide a separate room specifically for chlorination.
3. Locate controls and electrical equipment in a room separate from piping, pumps, and motors. The floor of the electrical/control room shall be raised above the pump room floor level, or all electrical and control equipment shall be installed on raised housekeeping pads.
4. Locate buildings a minimum of 20 feet from plant site property lines to facilitate access for maintenance and repair.
5. Buildings shall conform to applicable local, state, and federal building codes and requirements, including OSHA requirements.
6. Concrete work shall conform to the latest revision of ACI 318, ACI 301, and other applicable ACI specifications.
7. A soils investigation with recommendations for foundation design shall be performed by a geotechnical engineer.
8. Pump buildings shall be constructed of fire-proof reinforced concrete or reinforced masonry construction; do not use metal buildings. Building and roof shall have a minimum design life of 15 years.
9. Wiring shall conform to the most current revision of the National Electric Code requirements for commercial or industrial wiring. Materials and equipment shall be approved and listed by Underwriters Laboratory.
10. Building interior spaces shall be sufficiently lighted to allow for safe and convenient operation and maintenance of equipment including pumps, motors, motor control centers, and auto-sensory equipment. Provide exterior lighting at exterior doors, walkways, driveways, and work areas around the buildings. Follow lighting requirements contained in OSHA standards.

B. Size of Buildings and Clearances:

1. Building size shall depend on specific piping layouts, number of pumps and space allotted for future expansion. Building size shall be adequate to allow access to pumps, motors, piping, valves and electrical controls to allow for proper maintenance and removal of equipment or installation of future equipment.
2. Provide 3 feet minimum clearance between walls and piping, valves, and fittings to

facilitate bolt removal and tightening.

3. Space pumps and motors to allow for maintenance of equipment.
4. Provide steps, ladders and walkways as required for access to above ground equipment and valves. Provide safety handrails on walkways, ladders, and steps in accordance with OSHA regulations.
5. Provide outside access to the pump room through double doors or roll-up type garage doors. Size doors to allow removal and replacement of pumps and motors.
6. Provide control/electrical room with one exterior door and one door into the pump room.
7. Provide sidewalks, steps, and/or ramps as necessary to provide paved access to exterior doors as required by ADA.
8. Provide adequate vertical clearance inside the pump room to allow pumps to be pulled for service. Clearance shall allow pumps to be removed from the building over piping, pumps, and other equipment. The use of an access hatch in the roof for pump removal may be allowed provided building code requirements are met and the City Engineer approves.
9. Provide a traveling crane inside the building. Size the crane to easily handle large pump equipment. For smaller pumps, provide access suitable for manual lifting devices. The use of an access hatch in the roof for pump removal may be allowed provided building code requirements are met and the City Engineer approves.
10. Slab elevation shall be a minimum of 6 inches above grade to allow for proper drainage.

C. Ventilation:

1. Provide louvers of adequate size and number for proper ventilation of the pump room. Locate louvers so that good air circulation is maintained. Provide power roof fans, wall fans, or ventilators if necessary.
2. Provide louvers and fans in the control/electrical room sufficient to dissipate heat generated from motor control centers and switchgear. Consider use of dehumidifiers and heaters in control rooms if warranted.
3. Provide bird screening over louver and fan openings. Screening shall be 316 stainless steel, 16 mesh.

D. Piping:

1. Piping arrangements and sizes will depend upon initial equipment installed, proposed future expansions, and ultimate design capacity of the plant. See Section 15.05, Headers and Yard Piping, for specific design criteria.
2. Piping shall be adequately supported and properly braced to restrain thrust forces.
3. Provide sleeves for piping passing through walls. Line sleeves with expansion joint material to allow for minor movements of piping and buildings. Do not use building walls to support piping.

E. Roof:

1. Provide either:
 - a. A pitched roof with a minimum 5 on 12 slope with standing seam roofing of pre-coated galvanized steel or fiberglass asphalt shingles, or
 - b. Minimum 4-ply hot applied built-up roof with 15-year service life, adequately sloped for drainage.
2. Slope roof to drain away from entrance doors. Provide a minimum 2-foot overhang on all sides of the building.

F. Floor:

1. Provide a minimum 6-inch thick concrete floor.
2. Coat the floor with non-skid, chemical resistant material.

14.07 ELECTRICAL, MONITORING AND CONTROL SYSTEMS

A. General:

1. The water plant shall be provided with electrical controls and equipment to enable it to operate manually and automatically. Provide sufficient control and electrical equipment so that the water plant can operate automatically without direct operator control.
2. As a minimum, water plants shall be equipped with the systems as described herein. At the discretion of the Engineer, more complex systems may be provided.
3. Provide a time delay system to start large motors sequentially. Large motors shall not start simultaneously.
4. Primary control for equipment will use SCADA for all water plants operated and controlled by City of Richmond.
5. Each well and booster pump will have a non-resettable run time hour meter.

B. Well Control System:

1. Water wells shall be controlled based on the levels in ground or elevated storage tanks, if provided.
2. Interlock well controls with the well pump motor electrical equipment so that the well pump motor is activated and deactivated automatically in response to tank level. Time delay on the well pump motor shall reset in the event of a power disruption.
3. Tank level shall be sensed by an internal tank probes, an electronic pressure transmitter.
4. Unless approved by the City, secondary control equipment shall be one of the following types:
 - a. Electronic mercury-type pressure switches with conventional relays.
5. Provide a high-pressure mercoid switch with manual reset on well discharge.
6. Chlorination control shall be in accordance with TCEQ requirements.

C. Booster Pump Control System:

1. Systems Without Elevated Tanks:
 - a. Control of booster pumps shall be based on the pressure in the distribution system.
 - b. Interlock booster pump controls with pump motor electrical equipment so that successive pumps are activated on falling system pressure and deactivated on rising system pressure.
 - c. Make distribution pressure tap in either the water or air portions of the hydro-pneumatic tank or in the discharge line.
 - d. Unless approved by the City Engineer, control equipment shall be one of the following types:
 - i. Electronic mercury-type pressure switches with conventional electrical relays.
 - ii. Electronic pressure switches or pressure transmitters with either conventional electrical relays or programmable controller.
 - e. The following control features are required:
 - i. Booster pumps shall be deactivated on low ground storage tank level with a manual override provided.
 - ii. Booster pump controls and hydro-pneumatic tank controls shall be interlocked to ensure that the proper air-water ratio is automatically maintained in the tank.
2. Systems with Elevated Tanks:
 - a. Booster pumps can be controlled based on distribution system pressure as described above for systems without elevated tanks or on the water level in the elevated tank.
 - b. If the booster pumps are controlled by the elevated tank water level, the following are applicable:
 - i. If the elevated tank is at a different location than the booster pumps, the tank water level shall be transmitted to the water plant via SCADA.
 - ii. Interlock booster pump controls with motor electrical equipment so that successive pumps are activated on falling tank level and deactivated on rising tank level.
 - iii. Unless approved by the City Engineer, control equipment shall be one of the following types:
 - a. Electronic mercury-type pressure switches with conventional electrical relays.
 - b. Pressure transmitter with either conventional electrical relays or programmable controller.
 - iv. Provide a backup control system to automatically control the booster pumps in the event of loss of telemetry signal from the elevated tank.
 - v. Booster pumps shall be deactivated on low ground storage tank level with a manual override provided.

D. Telemetry:

1. Control communication between a water plant and an offsite well or elevated tank shall be accomplished using SCADA equipment with radio.
2. Telemetry equipment may utilize hard wire connection, telephone lines, radio communication, or microwave.

E. Water Plant Monitoring Systems:

1. As a minimum, provide the following:
 - a. Propeller-type flow meter located at the water well and a magnetic flow meter at the booster station. Meter shall have a totalizer that cannot be reset. Do not use battery-powered meters.
 - b. Panel-mounted, 4-1/2-inch diameter pressure gauge indicating the plant distribution pressure and Ground Storage Tank level, located in the electrical/control room.
 - c. Between discharge header and distribution system, provide a water meter. Provide 10 pipe diameters of straight pipe leading into the water meter and a minimum of 2 pipe diameters of straight pipe downstream of the water meter or install in accordance with meter manufacturer's recommendations, whichever is greater. Magnetic flow meter shall be above ground with a bypass loop underground.
2. The following may be provided at the discretion of the City Engineer:
 - a. 7-day wheel chart recorders sized such that peak conditions do not exceed 95 percent of full scale. Distribution pressure, elevated storage and ground storage tank levels, or plant discharge flows may be recorded. Do not use strip recorders.
 - b. Alarm lights and audible and visual alarm system to indicate abnormal conditions.

F. Electrical Systems:

1. Electrical Service:
 - a. Coordinate electrical service requirements with the appropriate utility company.
 - b. The reliability of the electrical system should be the first consideration. Include automatically resetting phase monitor relays and surge arrestors.
 - c. Primary service may be brought into the water plant site.
2. Motor Control Centers:
 - a. Design in accordance with applicable National Electrical Code requirements.
 - b. Locate indoors and provide durable nameplates on cubicles.
 - c. Provide elapsed time meters for booster pumps and well pumps.
 - d. Provide running lights for booster pumps and well pumps.
 - e. Provide durable nameplates identifying all switches, lights, gauges, etc.
 - f. Provide integrated short circuit rating in excess of that available from the utility company.
3. Wiring and Conduit:

- a. Size in accordance with National Electrical Code requirements.
- b. All wiring shall be installed in conduits as follows:
 - i. Below grade - PVC conduit encased in red concrete.
 - ii. Indoors - rigid aluminum or hot-dipped galvanized steel conduit. Pending on the area classification PVC coated galvanized steel pipe may be required.
 - iii. Chlorine rooms - Schedule 80 PVC conduit.
 - iv. Other locations - rigid aluminum or hot-dipped galvanized steel conduit.
- c. All wiring shall be copper.

4. Lighting:

- a. Indoor lighting shall be fluorescent, metal halide or LED.
- b. Exterior lighting shall be high-pressure sodium, metal halide or LED and shall illuminate the well and other working areas.

5. Grounding:

- a. Provide electrical service and equipment grounding as necessary to ensure grounding continuity and to ensure safety and reliability in the electrical system.
- b. When multiple motors are designed, provide a ground loop or a ground grid with multiple rods.

G. Specifications:

- 1. Include product specifications for major electrical and control equipment and devices.
- 2. Include brief written functional description of automatic plant operations.

14.08 HYDROPNEUMATIC TANKS

A. Construction:

- 1. Locate tanks wholly above grade. Tanks shall be constructed of steel with welded seams in accordance with ASME Pressure Vessel Code. Tanks shall be ASME stamped and approved.
- 2. Metal thickness shall be sufficient to provide at least a minimum 1/8-inch corrosion allowance and to withstand the highest expected working pressures with a four to one factor of safety.
- 3. Protective paint or coating applied to the inside or outside portions of the tank shall conform to current TCEQ standards.
- 4. No used tanks.

B. Provide appropriate valving to isolate each hydro-pneumatic tank from other portions of the system.

C. Appurtenances:

1. Provide automatically functioning facilities for maintaining the air-water volume at the design water level and working pressure.
2. Provide a pressure release device and an easily readable pressure gauge for each tank.
3. Provide a sight gauge for reading water level in each tank.
4. Provide tanks with a means for completely draining the tank.
5. Air compressors shall be sized for a minimum of 0.25 cfm per 1,000 gallon tank capacity at 150 psi.
6. Tanks shall have an access port for periodic inspections.
7. Provide freeze protection for tank appurtenances.
8. Specifications shall include tank capacity dimensions, appurtenances, pressure rating, disinfection procedures, and air compressor capacity.

14.09 POTABLE WATER STORAGE TANKS

A. Ground Storage Tanks:

1. Types of Construction:
 - a. Design welded steel tanks in accordance with the current revision of ANSI/AWWA D100. Steel fabrication dimensional tolerances shall be in accordance with API standards.
 - b. Design bolted steel tanks in accordance with the current revision of AWWA D103. Galvanized tanks are not allowed.
 - c. Design concrete tanks in accordance with current revision of AWWA D110.
 - d. A complete soils investigation with recommendation for foundation design shall be performed by a geotechnical engineer.
2. Design Requirements for Steel Ground Storage Tanks:
 - a. Tank inlets: Minimum one per tank located in the sidewall of the tank and at least 180 degrees from a tank outlet. Direct flow shall have a 45-degree bend away from the nearest outlet. Tank inlets shall be top fill.
 - b. Tank outlets: On single tank installations, outlet shall be located 180 degrees from inlet. On multiple tank installations, outlets are required to be able to feed the booster station with either tank out of service. Outlets for booster pump suction shall be fitted with an internal 90-degree fitting turned downward. Diameter shall be equal to or larger than the suction line. The fitting shall be a ductile iron flange and flare, a ductile iron 90 degree long radius ell, or a welded steel mitered fitting. Provide outlets with a minimum 12-inch clearance from the tank bottom.
 - c. Overflow: Provide an internal overflow weir inlet with an external overflow pipe.

The overflow assembly shall be sized to handle the maximum tank influent rate with a maximum water level rise over the inlet weir of 6 inches. The overflow pipe discharge shall terminate above ground, not be subject to submergence, and be fitted with a hinged flap valve. Top of overflow weir shall be a minimum of one foot below bottom of any roof rafter.

- d. Tank drain: One or more, not less than four inches in diameter, with valve, located a minimum practical distance above the tank floor to flow line of drain. For example, a 4 or 6-inch drain would be placed six inches above the tank floor. Larger drain sizes may be placed further from the floor. Alternatively, the Engineer may use a flush type drain in accordance with API 650, Section 3.7.8, Figure 3-10. The drain may be connected to the overflow discharge pipe outside the tank.
 - e. Interconnect line between tanks: Required for plants with more than one tank. Size the same as the tank inlet, or if combined with a tank outlet, size the same as the tank outlet, whichever is larger. Provide with isolation valves. Three valves on a tee are required if combined with a tank outlet. Locate a minimum of 12 inches above the tank bottom.
 - f. Roof vents: One or more with one vent located at or near the center of the roof at the highest point practical. Size vents for maximum influent and effluent rates. Only the effective (net) screen opening shall be considered to pass airflow. Vents shall be of the gravity type with openings protected by 316 stainless steel screen, 16 mesh.
 - g. Foundation: The tank manufacturer shall be responsible for the foundation design. Support the tank bottom on a concrete ring-wall of minimum 12-inches wide. The top of the foundation shall be at least 12 inches above finished grade. The tank bottom shall rest on a minimum of 6 inches of clean sand, free from clay, lumps, shale, loam, organic matter and other deleterious materials, with soluble ionic (salt) content limited in accordance with ASTM D4940. Slope the tank bottom at least 1 inch in 10 feet from the tank center to the outside edge.
 - h. Connections: Connections 4 inches and larger shall be flanged. Connections 3 inches and smaller may be threaded couplings.
 - i. All Steel Welded Tanks shall be a four foot (4') floor level manway with davit arm.
3. Design Requirements for Pre-stressed Concrete Ground Storage Tanks:
- a. Tank inlets: At least one per tank located at least 180 degrees from a tank outlet. Make inlet connections through the tank bottom and provide a minimum 4-inch silt stop.
 - b. Tank outlets: Number and plan location is the same as for steel tanks. Make outlet connections through the tank bottom and provide a minimum 4-inch silt stop.
 - c. Tank overflow: Provide an internal overflow weir with an external overflow pipe. Size the overflow assembly to handle the maximum tank influent rate with a maximum water level rise over the weir of 6 inches.

- d. Tank drain: One or more with an isolation valve. Make drain connections through the tank bottom and terminate in an open top concrete drain box connected to a storm sewer system or adequate site drainage swale. Tank shall have an adequate sump to facilitate cleaning.
- e. Interconnect lines between tanks are required.
- f. Roof Vents: One or more with one vent located at or near the center of the roof at the highest point practical. Size the vent for maximum influent and effluent rates. Only the effective (net) screen opening shall be considered to pass airflow. Vents shall be of the gravity type with openings protected by 316 stainless steel screen, 16 mesh.
- g. Foundation: The tank manufacturer shall be responsible for the foundation design. The tank bottom may be below natural ground level.

4. Required accessories

- a. Roof hatch: Primary roof hatch shall have a minimum size of 30-inch diameter with 4-inch curb and shall have a cover with 2-inch downward overlap and provisions for locking. Primary location shall be offset from the exterior tank ladder centerline and located over the interior ladder. The secondary roof hatch shall be located over the tank overflow.
- b. Ladders: Provide an exterior steel ladder extending the full height of the tank. Provide exterior ladders with safety cage. Interior ladders shall be provided and offset from external ladder by at least 2 feet.
- c. Roof guard rails: Provide guard rails (handrails) along the roof edge for a distance of 10 feet either side of the exterior ladder and 5 feet either side of any perimeter tank appurtenance.
- d. Shell manways:
 - i. Welded steel tanks - Provide at least two. One manway shall be 30 inches in diameter with hinged cover per AWWA standards. One manway shall be 48 inch x 48-inch flush-type cleanout per API standards complete with hinge or davit arm. Locate the manholes approximately 180 degrees apart.
 - ii. Bolted steel tanks - Provide two flush-type cleanouts per API standards. Cleanouts shall be a minimum of 24 inches wide by 48 inches high and located approximately 180 degrees apart.
 - iii. Concrete Tanks - provide at least four manways spaced approximately 90 degrees apart - shape shall be elliptical 24 inches by 18 inches minimum.
- e. Miscellaneous accessories: One sample cock located 3 feet above tank bottom and one pressure gauge calibrated in feet of water located 3 feet above tank bottom. Visual level board shall be provided on the exterior of the tank. Background shall be white with black numbers and hash marks. Level target shall be red and connected to a stainless steel cable and stainless steel float.

- f. Provide non-skid walkways on the roof to reach any appurtenance.

B. Elevated Storage Tanks

1. Types of construction - Reference Standard - AWWA D100, with no restriction on the style of tank.
2. Design requirements
 - a. Tank overflow: Provide an internal overflow weir and drain pipe. Size the overflow assembly to handle the maximum tank influent rate with a maximum water level rise over the weir of 6 inches. The overflow pipe shall be piped to grade and shall be fitted with a hinged flap valve. Top of overflow funnel shall be a minimum of 1 foot below bottom of any roof rafter.
 - b. Roof vents: One or more with one vent located at or near the center of the roof at the highest point practical. Size the vent for maximum influent and effluent rates. Only the effective (net) screen opening shall be considered to pass airflow. Vents shall be of the gravity type with openings protected by 316 stainless steel screen, 16 mesh, and designed as a secondary roof opening.
 - c. Altitude control valve: Equip all tanks with an altitude control valve.
 - d. The tank foundation shall be the responsibility of the tank manufacturer.
 - e. Lighting: Provide interior lighting in the dry compartment.
 - f. Comply with Federal Aviation Administration requirements with respect to warning lighting.
3. Required Accessories:
 - a. Roof hatch: Minimum size 30-inch diameter with 4-inch curb and cover with 2-inch downward overlap and provisions for locking.
 - b. Provide necessary handrails, ladders, balconies, and safety devices per OSHA requirements.
 - c. Provide one sample cock and one pressure gauge calibrated in feet of water.

C. Protective Coatings

1. Welded steel tanks shall be coated per TCEQ and AWWA standards on the inside and outside excluding galvanized accessories.
2. No coatings are required for concrete tanks, except for tank accessories that are not galvanized.
3. Coating Systems:
 - a. Coating system for the interior of the tank shall be in accordance with TCEQ requirements, must conform to ANSI/NSF Standard 61, and must be certified by an organization accredited by ANSI for use as a contact surface with potable

- water.
 - b. Coating system for the exterior of the tank may be as required for exposure conditions and desired aesthetics.
 - c. Do not use coating materials containing lead.
 - 4. Cathodic protection for the interior submerged surfaces of welded steel tanks is not required but may be provided at the discretion of the Engineer.
- D. Specifications - Indicate type of coating system and cathodic protection system, if provided.

14.10 EMERGENCY POWER

A. General:

1. Provide emergency power as required by TCEQ regulations. A generator is the preferred type of emergency power. If the Engineer selects an alternate method, reasons for the use of the alternate method must be presented with the drawings.
2. If right angle drives are used, they shall be diesel powered and/or natural gas powered. Do not use gasoline engines.

B. Preferred Method - Generator:

1. A generator shall be used. The generator shall operate the following items as a minimum:
 - a. The controls, air compressor, panel lights, and exterior lights.
 - b. The booster pumps, as necessary to maintain minimum pressures, or
 - c. All booster pumps, not including standby pumps, if applicable.
 - d. Controls shall have the capabilities for monitoring through the use of telemetry (SCADA)

C. Right Angle Well Drive:

1. A right angle well drive may not be used alone. A right angle drive on the well shall be accompanied by a right angle drive on at least one booster pump or a generator as outlined in this section.
2. Manual well operation is permitted.

D. Alternate Method (used only with City approval) - Right Angle Booster Pump Drive:

1. A right angle booster pump drive unit may be used if a well right angle drive is used. The well may fill the ground storage tank by manual operation. The booster pump right angle drive unit may have manual start capabilities.

E. Fuel Tanks.

1. For diesel engines, a fuel tank shall be provided which allows 24 hours of operation at full load if system is interconnected or multiple plants are in the system
2. Above ground tanks shall be used and must be Underwriters Laboratories (UL) listed (Do not use underground fuel tanks) and shall be of dual walled construction. A UL label

shall be affixed to the tank.

3. Provide concrete or steel containment for the fuel tank in accordance with NFPA 30. Containment shall have a drain line with a lockable valve.
4. Use black steel piping for fuel tank connections. Do not use galvanized steel piping.

14.11 CHLORINATION SYSTEMS

A. General:

1. Provide a chlorination system for groundwater plants to disinfect the water supply.
2. Chlorinate water before it enters the ground storage tank (pre-chlorination). Provisions for chlorinating water after it leaves the ground storage tank, but prior to entering the distribution system (post-chlorination), may be provided at the discretion of the Engineer and with City Engineer and Texas Commission on Environmental Quality approval.
3. The source of chlorine shall be the use of Sodium Hypochlorite (12.5% concentration) or the use of 150-pound cylinders, which contain chlorine under pressure. Other chlorine sources or other methods of disinfection shall require prior approval of the City Engineer.

B. Types of Systems:

1. Pre-chlorination:

- a. Chlorination of the plant's groundwater supply shall be accomplished by providing either (1) a fixed rate chlorinator for each well feeding the plant; or (2) a variable rate chlorinator or multiple fixed-rate chlorinators in plants with multiple wells and a common well collection line. Chlorinator equipment shall be compatible with the disinfection method proposed.

b. Chlorination Points:

- i. Add chlorine solution to the above ground well collection pipe downstream of the well flow meter, prior to entering the ground storage tank, and prior to reaching the well connection to the distribution system.
- ii. Chlorination connections for 1-inch and smaller solution lines through 3-inch solution lines shall be a pipe tap connection utilizing a service saddle with a shut-off valve and check valve. The diffusion tube shall project into the pipe approximately one-third the pipe diameter or as recommended by the manufacturer.

c. Control Methods:

- i. Chlorinators shall operate automatically whenever there is flow of water into the ground storage tanks or when the wells are running.
- ii. Single well, fixed feed rate chlorinators shall be controlled by an electric solenoid valve in the injector water supply line. The solenoid valve shall

open automatically when there is well flow.

- iii. Multiple well variable feed rate chlorinators shall be controlled by an electric solenoid valve in the injector water supply line. The solenoid valve shall open automatically when there is well flow. A flow meter with flow rate transmitter is required in the common well collection line for control of the chlorine feed rate.
- iv. Multiple well/multiple fixed rate chlorinators function as single well fixed rate chlorinators with a separate solenoid for each well tied to that well's fixed rate chlorinator.
- v. A by-pass is required for each solenoid.

2. Post-chlorination (if provided):

- a. Chlorination of water after leaving the ground storage tanks shall be accomplished by a variable rate chlorinator.
- b. Chlorination points:
 - i. Add chlorine solution to the booster pump suction piping. If possible, make chlorination connections to above ground pipe. Connections to buried pipe shall be made inside a vault-type structure.
 - ii. Chlorination connections shall be the same as those required for pre-chlorination.
- c. Control methods:
 - i. Chlorinators shall operate automatically whenever they are turned on and there is flow in the booster pump suction lines.
 - ii. Chlorinators shall be controlled by an electric solenoid valve in the injector water supply line. The chlorine feed rate may be controlled based on the distribution flow rate (flow proportional control) or based on the free chlorine residual of the water as it leaves the ground storage tanks (direct residual control).

C. Design Requirements:

- 1. The design dose rate for pre-chlorination shall be adjustable from 0 to 4 mg/l or sized as required to meet regulatory compliance. The design dose rate for post-chlorination shall be adjustable from 0 to 1.5 mg/l or sized as required to meet regulatory compliance.
- 2. Chlorinators:
 - a. Chlorinators shall be remote vacuum, solution feed type for chlorine gas or metering pump for liquid disinfection.
 - b. Fixed-rate chlorinators shall be packaged wall-mounted units complete with a manually adjustable orifice, rotameter, and injector.

- c. Variable-rate chlorinators shall be packaged wall-mounted or freestanding units with an electric controlled rotameter to automatically adjust the chlorine feed rate, with remotely mounted injector, and rotameter.
 - d. Metering pump shall be able to control the chemical feed rate by the speed and stroke of the unit. The metering pump shall be controlled by the on/off command of the well or booster pump. Metering pump can be equipped with a 4-20 milliamp signal to control the dosage automatically based upon the flow of the wells or booster pumps.
 - e. A stand-by chlorinator is optional.
 - i. Accessories to be provided include weight scales, automatic switchover vacuum regulator - check units, a pressure relief valve, and necessary piping and valves.
 - ii. Or an additional metering pump.
3. Injector Water Supply:
- a. The source of water for the injector should normally be the high-pressure side of the distribution booster pumps.
 - b. Provide a chlorine booster pump sized to provide the full required injector operating pressure. The chlorine booster pump shall take suction from the well line.
 - c. If the water well is designed to pump directly into the distribution system during power outage conditions, provide an auxiliary power source for the chlorine booster pump.
 - d. The injector water supply piping shall include an electric solenoid valve with valved bypass, a strainer, and necessary piping and valves.
4. For Chlorine Gas: The chlorinator room shall be a separate room or structure separated from other plant facilities. The structure shall be masonry or fiberglass and shall include a ceiling-level inlet fan or fans, a floor-level back-draft damper, a heater, and outside light and fan switches.
5. For Chlorine Gas: Required accessories include a gas mask, diffuser assembly, wind sock assembly, and chlorine leak detector.
- a. A chlorine leak detector shall be located in each room (or structure) containing chlorination equipment, including open frame-type ton container structures.
 - b. The chlorine leak detector shall activate an alarm circuit that includes as a minimum a red rotating beacon which can be seen by the plant operator upon entering the plant site.
 - c. Provide a single self-contained breathing apparatus with 30-minute supply for each plant. Locate the breathing apparatus close to but outside of rooms or structures containing chlorination equipment.
 - d. A wind sock shall be installed on the building to identify wind direction.

D. Specification Requirements: Include the following requirements in the specifications:

1. For Chlorine Gas:
 - a. Chlorinator design feed rate and rotameter capacity.
 - b. Injector back pressure.
 - c. Chlorine booster pump rating.
 - d. Chlorine leak detection levels.
 - e. Injection equipment.
2. For Sodium Hypochlorite:
 - a. Design Feed Rate.
 - b. Chlorinator pump,
 - c. Injection equipment.
 - d. Storage container and containment.

14.12 INITIAL WATER PLANTS

A. General

1. This chapter applies to development projects for, and up to, 250 equivalent residential connections required to provide potable water to future residential, commercial and/or industrial users that are located within the ETJ and have a City of Richmond approved regional water supply and distribution plan.
2. Approval to construct initial water plants pursuant to this section is contingent upon submittal of an overall regional water supply and distribution plan for the development. The overall plan shall provide the preliminarily location and capacity of primary water plants, initial water plants, remote water wells, and trunk distribution lines. The overall plan shall contain a phasing plan that sets development milestones (i.e. dates, number of connections, etc.) for implementation of the ultimate water supply and distribution plan.
3. Conform to requirements contained in all other sections and chapters of this manual unless otherwise noted.

B. Wells:

1. Public wells shall be gravel packed, as per Section 15.03, as needed, based on specific hydro-geological conditions at the proposed well site. Maximum capacity shall be 600 gallons per minute (gpm), if greater than 600 gpm are required, the ultimate well shall be constructed per the design standards. Address size, wall thickness (minimum 0.375 inch), and planned length of casing and liner in specifications.
2. Locate wells 600 gpm or larger a minimum of 2,000 feet from another well, which is screened in the same aquifer. Wells less than 600 gpm shall be a minimum of 1,000 feet from other wells less than 600 gpm. No minimum separation is required if the wells are in different aquifers. When possible, do not locate new public water supply wells on the perimeter of the development it is to serve.
3. Minimum well size shall be 300 gpm.

- a. Size casing and liner (interior casing) diameters to allow the pump to be lowered into the liner based on the manufacturer's minimum clearances between pump and liner. Maximum velocity between the pump and liner shall not exceed 8 feet per second.

C. Booster Pump:

1. Minimum combined booster pump capacity shall be 1000 gallons per minute.

D. Booster Pump Buildings

1. For plants without booster pump buildings, provide a minimum 6 inch thick concrete booster pump pad that extends at least 1 foot in each direction beyond the area required for the proposed booster pumps.
2. Conform to shelter requirements for disinfection and electrical components identified in other sections of this chapter.

E. Potable Water Storage Tanks:

1. Minimum ground storage tank volume shall be 80,000 gallons.

F. Emergency Power:

1. Provide emergency power or provide electrical and mechanical devices necessary for quick connection of a portable generator. Plant operator shall be responsible for delivery, hookup and operation of the emergency power generator.

G. Testing:

1. Step test completed well at 80%, 100%, 120% and 150% of design capacity for a minimum of 3 hours each with 3 hours of recovery between each step to confirm final selected capacity.
2. Test well at final selected capacity for 4 hours to verify stability in draw down.
3. An attempt shall be made to reach a specific capacity of 18 gallons-per-minute-per-foot of drawdown for a gravel-packed well and 10 gallons per minute per foot of drawdown for a straight-wall well after 4 hours of continuous well operation.

END OF CHAPTER



City of Richmond

Design Manual

Chapter 15

GRAPHIC STANDARDS & DRAWING REQUIREMENTS

CHAPTER 15

GRAPHIC STANDARDS & DRAWING REQUIREMENTS

15.01 GENERAL

- A. These standards describe the general requirements for construction plan graphics, drawing layering, attribute fields, and data requirements.
- B. Construction plans for all public improvements within the Richmond city limits or extraterritorial jurisdiction shall be approved by the Public Works Department.
- C. Construction plans for private improvements, within public right-of-ways and public easements that connect to or affect the public infrastructure shall be approved by the Public Works Department, are subject to the requirements of this manual, and are subject to review and approval using the process defined in this manual.
- D. All As-Built construction plans shall be submitted to the City of Richmond Public Works Department in traditional paper format and in electronic formats. An ESRI GIS Feature Class within a Geodatabase (preferred) or Shapefile, and an AutoCAD drawing file (version 2013 or later), are both required. See GIS and AutoCAD standards below.

15.02 GIS AND AUTOCAD STANDARDS & DATA REQUIREMENTS

- A. As part of the final acceptance package the following items shall be submitted in electronic format:
 - 1. An ESRI GIS Feature Class within a Geodatabase (preferred) or Shapefile, and an AutoCAD drawing file (version 2016 or later) of the following facilities:
 - i. Water Utilities
 - ii. Sanitary Sewer Utilities
 - iii. Storm Sewer Utilities
 - iv. Pavement
 - v. Benchmarks / Control Point
 - 2. GPS Monument / Benchmark / Control Point
 - i. Refer to Chapter 2

3. Construction cost or bid tabulation for pavement, utilities and sidewalks
 - i. Line item or simply total cost is appropriate
4. Upon completion of all projects, the As-Built updates and revisions shall be incorporated into the delivered ESRI GIS Feature Class within a Geodatabase (preferred) or Shapefile, and AutoCAD drawing file (version 2013 or later).
5. A copy of the engineer certified As-Built record drawings in a PDF format containing the As-Built revisions.
6. Electronic files delivered on CD shall contain a text file of the CD contents and include the project name and number on the CD label.

15.03 ESRI GIS FEATURE CLASS WITHIN A GEODATABASE OR SHAPEFILE GENERAL GUIDELINES

- A. The standards described in this chapter define the general requirements for the ESRI GIS Feature Class within a Geodatabase (preferred) or Shapefile.
- B. The ESRI GIS Feature Class within a Geodatabase (preferred) or Shapefile shall include applicable point, line, and polygon features for all water utilities, sanitary sewer utilities, storm sewer utilities, paving, and benchmarks/control points as outlined in this chapter.
- C. The ESRI GIS Feature Classes within a Geodatabase (preferred) or Shapefiles shall have the following spatial characteristics:
 1. NAD 83
 2. State Plane Texas South Central FIPS 4204 Feet
 3. Grid Units
- D. The ESRI GIS Feature Class within a Geodatabase (preferred) or Shapefile Attribute Field Name, Type, and Content shall meet the requirements outlined in this chapter.

15.04 WATER UTILITIES FEATURE REQUIREMENTS AND DATA DESCRIPTIONS

A. Water Lines - Attribute Field Naming Conventions and Data Descriptions

FIELD NAME	DATA DESCRIPTION	DATA TYPE	WIDTH	PRECISION	SCALE
P_MAT_PK	Pipe Material Numeric Code Refer to CHART 15.01 WATER LINE RELATES	Short Integer	2	10	0
P_SIZE	Pipe diameter in inches	Double	8	38	8
P_DEPTH	Depth in inches	Double	8	38	8
SHEET_OF	Enter planset sheet number displayed as X of XX	Short Integer	0	12	0

B. Water Points - Attribute Field Naming Conventions and Data Descriptions

FIELD NAME	DATA DESCRIPTION	DATA TYPE	WIDTH	PRECISION	SCALE
V_TYPE_PK	Valve Type Numeric Code Refer to CHART 15.02 WATER POINT RELATES	Short Integer	5	5	0
V_SIZE	Valve size indicated in inches as a whole number	Short Integer	0	5	0
H_MANUFCTR_PK	Hydrant Manufacturer Numeric Code Refer to CHART 15.02 WATER POINT RELATES	Short Integer	0	5	0
H_ID	Hydrant unique identifier number	Text		12	
SHEET_OF	Enter planset sheet number displayed as X of XX	Short Integer	0	12	0

IF THE MATERIAL BEING USED FOR A PROJECT IS NOT LISTED, PLEASE CALL THE CITY OF RICHMOND PUBLIC WORKS AT **281.342.0559** FOR THE RELATES NUMBER

CHART 15.01 WATER LINE RELATES

Record: P_MAT_PK

- 2 CLASS 140 ASBESETOS-CEMENT
- 8 UNKNOWN
- 13 DUCTILE IRON PIPE
- 14 REINFORCED CONCRETE PIPE
- 23 PVC C-900
- 24 CAST IRON
- 25 SERVICE CONNECTION
- 41 BORE & JACK
- 47 WELDED STEEL PIPE
- 62 COPPER
- 77 HDPE-POLYETHYLENE PIPE

CHART 15.02 WATER POINT RELATES

Record: V_TYPE_PK

- 1 TAPPING SLEEVE & VALVE
- 2 BLOW OFF
- 3 CONTROL VALVE
- 4 GATE VALVE
- 5 UNKNOWN
- 6 N/A
- 7 FLUSH VALVE
- 8 COUPLER VALVE

Record: H_MANUFCTR_PK

- 1 MUELLER
- 2 KENNEDY
- 3 AMERICAN DARLING
- 4 CLOW
- 6 N/A
- 7 UNKNOWN

- 9 CHECK VALVE
- 10 GLOBE VALVE
- 11 FIRE HYDRANTS
- 12 BALL VALVE
- 13 BUTTERFLY VALVE
- 14 AIR RELEASE VALVE

15.05 SANITARY SEWER UTILITIES FEATURE REQUIREMENTS AND DATA DESCRIPTIONS

A. Sanitary Sewer Lines - Attribute Field Naming Conventions and Data Descriptions

FIELD NAME	DATA DESCRIPTION	DATA TYPE	WIDTH	PRECISION	SCALE
P_MAT_PK	Pipe Material Numeric Code Refer to CHART 15.03 SANITARY SEWER LINE RELATES	Short Integer	8	5	0
P_SIZE	Pipe diameter in inches	Short Integer	5	38	8
FL_HIGH	Highest end of pipe in feet as indicated by the flow line (F/L)	Double	0	38	8
FL_LOW	Lowest end of pipe in feet as indicated by the flow line (F/L)	Double	0	38	8
P_GRADE	Slope of pipe as indicated by percentage. Display as a decimal without a percentage notation	Double	0	38	8
F_MAIN	Enter 1 if line is a force main; Enter 0 if it is not	Text	0	255	
SHEET_OF	Enter planset sheet number displayed as X of XX	Short Integer	0	12	0

B. Sanitary Sewer Points - Attribute Field Naming Conventions and Data Descriptions

FIELD NAME	DATA DESCRIPTION	DATA TYPE	WIDTH	PRECISION	SCALE
MH_MAT_PK	Manhole Material Numeric Code Refer to CHART 15.04	Short Integer	0	5	0

SANITARY SEWER POINT RELATES					
MH_RINGSIZE	Diameter of the manhole	Short Integer	0	5	0
MH_COATED	Enter Y (yes) or N (no)	Text	0	2	0
MH_ID	Manhole unique identifier number	Text		12	
IN_ELEV IN_ELEV2 IN_ELEV3 IN_ELEV4	Elevation at which pipes flow in the manhole connect. Begin with highest elevation and enter all for mainline and leads. (unpopulated fields; Enter -9)	Double	0	38	8
RIM_ELEV	Elevation of the manhole cover	Double	0	38	8
OUT_ELEV	Elevation at which the outflow pipe is connected to the manhole	Double	0	38	8
V_TYPE_PK	Valve Type Numeric Code Refer to CHART 15.04 SANITARY SEWER POINT RELATES	Short Integer	5	5	0
SHEET_OF	Enter planset sheet number displayed as X of XX	Short Integer	0	12	0

CHART 15.03 SANITARY SEWER LINE RELATES

Record: P_MAT_PK

- 1 VETRIFIED CLAY PIPE
- 6 CONCRETE
- 8 UNKNOWN
- 12 PVC
- 13 DUCTILE IRON PIPE
- 14 REINFORCED CONCRETE PIPE
- 18 ASBESTOS-CEMENT
- 23 PVC C-900
- 24 CAST IRON
- 25 SERVICE CONNECTION
- 41 BORE & JACK

- 42 PVC SDR 26 CLASS 160
- 43 PVC DR 18 C-900 CLASS 150
- 47 WELDED STEEL PIPE
- 73 PVC SDR-35
- 80 HDPE-POLYETHYLENE PIPE

CHART 15.04 SANITARY SEWER POINT RELATES

Record: MH_MATERIAL_PK

- 9 N/A
- 2 CONCRETE
- 4 BRICK
- 5 FIBERGLASS
- 6 UNKNOWN
- 11 REINFORCED CONCRETE
PIPE
- 14 MANHOLE LIFTSTATION
- 15 AIR RELEASE VALVE

Record: V_TYPE_PK

- 1 GATE VALVE
- 2 CHECK VALVE
- 3 BALL VALVE
- 4 BUTTERFLY VALVE

15.06 STORM SEWER UTILITIES FEATURE REQUIREMENTS AND DATA DESCRIPTIONS

A. Storm Sewer Lines - Attribute Field Naming Conventions and Data Descriptions

FIELD NAME	DATA DESCRIPTION	DATA TYPE	WIDTH	PRECISION	SCALE
P_MAT_PK	Pipe Material Numeric Code Refer to CHART 15.05 STORM SEWER LINE RELATES	Short Integer	0	5	0
P_SIZE	Pipe diameter in inches (If a box culvert; Enter -9)	Short Integer	0	5	0
FL_HIGH	Highest end of pipe in feet as indicated by the flow line (F/L)	Double	0	38	8
FL_LOW	Lowest end of pipe in feet as indicated by the flow line (F/L)	Double	0	38	8

P_GRADE	Slope of pipe as indicated by percentage. Display as a decimal without a percentage notation	Double	0	38	8
BC_SIZE	Box Culvert size (ex. 10 x 5) (If not a box culvert; Enter - 9)	Text	0	8	0
MAJ_DRAIN	Enter 1 if major drain; Enter 0 if not	Short Integer	0	5	0
SHEET_OF	Enter planset sheet number displayed as X of XX	Short Integer	0	12	0

B. Storm Sewer Points - Attribute Field Naming Conventions and Data Descriptions

FIELD NAME	DATA DESCRIPTION	DATA TYPE	WIDTH	PRECISION	SCALE
MH_MATERIA	Manhole Material Type Numeric Code. Refer to CHART 15.06 STORM SEWER POINT RELATES (inlets and outfalls; Enter -9)	Long Integer	0	10	0
MH_RINGSIZ	Diameter of manhole lid in inches (inlets and outfalls; Enter -9)	Long Integer	0	10	0

INLET_TYPE	Inlet Material Type Numeric Code. Refer to CHART 15.06 STORM SEWER POINT RELATES (manholes and inlets; Enter -9) For manholes with inlet tops, enter the corresponding inlet number ensuring that the MH_MATERIA field indicates a manhole with inlet	Long Integer	0	10	0
OUTFALL_MA	Outfall Material Type Numeric Code Refer to CHART 15.06 STORM SEWER POINT RELATES (manholes and inlets; Enter -9)	Long Integer	0	10	0
OUTFALL_DE	Outfall Destination Numeric Code. Refer to CHART 15.06 STORM SEWER POINT RELATES (manholes and inlets; Enter -9)	Long Integer	0	10	0
MH_NUM	Manhole Number (inlets and outfalls; Enter -9)	Text	0	9	0
IN_ELEV IN_ELEV2 IN_ELEV3 IN_ELEV4	Elevation at which pipes flow in the manhole connect. Begin with highest elevation and enter all for mainline and leads. (unpopulated fields; Enter -9)	Double	0	38	8
RIM_ELEV	Elevation of the manhole cover	Double	0	38	8
OUT_ELEV	Elevation at which the outflow pipe is connected to the manhole	Double	0	38	8
MH_DIAMETER	Diameter of manhole in inches	Long Integer	0	10	0
SHEET_OF	Enter planset sheet number displayed as X of XX	Short Integer	0	12	0

CHART 15.05 STORM SEWER LINE RELATES

Record: P_MAT_PK

Record: MAJ_DRAIN

1	VETRIFIED CLAY PIPE	0	NO
4	CORRUGATED GALVANIZED METAL PIPE	1	YES
6	CONCRETE		
8	UNKNOWN		
11	PVC SDR-18		
12	PVC		
13	DUCTILE IRON PIPE		
14	REINFORCED CONCRETE PIPE		
15	OPEN DITCH		
18	ASBESTOS-CEMENT		
21	PRECAST CONCRETE BOX		
23	PVC C-900		
24	CAST IRON		
28	PROFILE REINFORCED HDPE		
31	PVC SDR-26		
33	ABS TRUSS		
37	TRIPLE BOX CULVERT		
41	BORE & JACK		
47	WELDED STEEL PIPE		
48	A.B.S. COMPOSITE		
55	BOX CULVERT		
59	SWALE		
63	ASPHALT COATED METAL PIPE		
64	WIER		
72	CONCRETE C-14 EXTRA		

STRENGTH

- 73 PVC SDR-35
- 76 ARCH PIPE
- 79 DUAL RCP SIPHON
- 80 CHANNEL 81 HARCOR OR SIMILAR
- 82 NATURAL FEATURE (CREEK, BAYOU, etc.)

CHART 15.06 STORM SEWER POINT RELATES

Record: MH_MATERIA

- 9 N/A
- 2 CONCRETE
- 4 BRICK
- 5 FIBERGLASS OR CONCRETE
- 6 UNKNOWN
- 9 MANHOLE WITH INLET TOP

- 11 REINFORCED CONCRETE PIPE
- 15 SPECIAL MANHOLE
- 16 JUNCTION BOX WITH MANHOLE TOP

Record: OUTFALL_MA

- 9 N/A
- 1 REINFORCED CONCRETE (RCP)
- 2 UNKNOWN
- 3 PYRAMAT
- 4 CORRUTGATED METAL
- 5 PVC
- 6 RIP RAP
- 7 DITCH
- 8 STEEL
- 9 NATURAL (SWALE /DITCH TO CREEK)

Record: OUTFALL_DE

- 9 N/A
- 0 STORM SEWER

Record INLET_TYPE

- 9 N/A
- 1 H-2
- 2 D
- 3 C-1
- 4 B-B
- 5 UNKNOWN
- 6 JUNCTION BOX
- 7 E
- 8 A
- 9 STRAW BALE DROP
- 10 STRAW BALE DROP W/GUARDRAIL
- 11 S
- 12 SIDEWALK
- 13 B
- 14 CATCH BASIN
- 15 C
- 16 C-3
- 17 F
- 18 GRATE
- 19 D1
- 20 DROP
- 21 GRATE
- 22 CURB
- 23 C-5
- 24 C-9
- 25 C-8
- 26 C-7
- 27 C-2
- 28 C-4
- 29 C-6
- 30 COURT DRAIN
- 31 3:1 RCP END SECTION

1	unknown	32	INVERTED CROWN DOUBLE INLET
2	PIPE	33	BERM INLET (AS# 300)
3	STREAM	34	BACKSLOPE INLET
4	DITCH	35	TYPE C WITH 40' EXTENSION
5	CULVERT	36	S-110
6	DRAINAGE FIELD	37	SPLASH BOX
7	DETENTION POND	38	DIRECT FEED INLET (FROM ROOF GUTTER)
8	LAKE	39	10' INLET
9	WETLANDS		
10	CHANNEL		
11	SWALE		

15.07 AutoCAD DRAWING FILE (VERSION 2013 OR LATER) GENERAL GUIDELINES

- A. The standards described in this chapter define the general requirements for the AutoCAD drawing file (version 2013 or later).
- B. The AutoCAD drawing file (version 2013 or later) shall include applicable point, line, and polygon features for all water utilities, sanitary sewer utilities, storm sewer utilities, paving, and benchmarks / control points as outlined in this chapter.
- C. The AutoCAD drawing file (version 2013 or later) shall have the following spatial reference characteristics:
 - 1. NAD 83
 - 2. State Plane Texas South Central FIPS 4204 Feet
 - 3. Grid Units
- D. If the spatial reference requirements for the AutoCAD drawing file (version 2013 or later) cannot be met, the City of Richmond will review on a case by case basis.
- E. The AutoCAD drawing file (version 2013 or later) Layers and Content shall meet the requirements outlined in this chapter.

15.08 AutoCAD DRAWING FILE (VERSION 2013 OR LATER) LAYER REQUIREMENTS

- A. As-Built construction drawings are to be provided in AutoCAD drawing file (version 2013 or later) with construction plan information in layers according to

the order shown in TABLE 15.01 LAYER SYMBOLOGY FOR CONSTRUCTION PLANS. Additional layers may be added as necessary.

TABLE 15.01 LAYER SYMBOLOGY FOR CONSTRUCTION PLANS

LAYER	LAYER NAME	DESCRIPTION
1	CL	Centerline
2	ROW	Right of Way
3	LOTLINE_PRO	Lot Lines/Reserves (Proposed)
4	BOUNDARY	Boundaries
5	BMARK	Richmond Benchmark
6	LOTNOS	Lot Numbers/Block Names
7	SUBDIVNM	Subdivision Names / Section Numbers
8	STREETNM	Street Names
9	WLNES_PRO	Water Lines (Proposed)
10	FHYD_PRO	Fire Hydrants (Proposed)
11	WVALVES_PRO	Water Valves (Proposed)
12	WTEXT_PRO	Water Line Text (Proposed)
13	SSLINES_PRO	Sanitary Sewer Lines (Proposed)
14	SSMH_PRO	Sanitary Sewer Manholes (Proposed)
15	SSFM_PRO	Sanitary Sewer Force Main (Proposed)
16	LS_PRO	Liftstation (Proposed)
17	SSTEXT_PRO	Sanitary Sewer Text (Proposed)
18	STORMLINE_PRO	Storm Sewer Lines (Proposed)
19	STORMMH_PRO	Storm Sewer Manholes (Proposed)
20	STORMIN_PRO	Storm Sewer Inlets (Proposed)
21	STORMCVT_PRO	Storm Sewer Culverts (Proposed)
22	STORMTEXT_PRO	Storm Sewer Text (Proposed)
23	DITCH	Drainage Ditch
24	TOPO	Topography
25	UTIL_PRO	Utilities (Proposed)
26	LAKES	Lakes/Ponds etc.
27	STREAM	Creeks, Bayous, Rivers etc.

28	CANAL	Canals
29	RR	Railroad
30	CITYLIM	City Limits Line
31	COUNTYLN	County Lines
32	ETJ	ETJ Lines
33	NOTES	Notes/ Miscellaneous Text
34	UTIL_EXI	Utilities (Existing)
35	LOTLINE_EXI	Lot Lines/Reserves (Existing)
36	WLINES_EXI	Water Lines (Existing)
37	FHYD_EXI	Fire Hydrants (Existing)
38	WVALVES_EXI	Water Valves (Existing)
39	WTEXT_EXI	Water Line Text (Existing)

Continued

LAYER	LAYER NAME	DESCRIPTION
40	SSLINES_EXI	Sanitary Sewer Lines (Existing)
41	SSMH_EXI	Sanitary Sewer Manholes (Existing)
42	SSFM_EXI	Sanitary Sewer Force Main (Existing)
43	LS_EXI	Lift station (Existing)
44	SSTEXT_EXI	Sanitary Sewer Text (Existing)
45	STORMLINE_EXI	Storm Sewer Lines (Existing)
46	STORMMH_EXI	Storm Sewer Manholes (Existing)
47	STORMIN_EXI	Storm Sewer Inlets (Existing)
48	STORMCVT_EXI	Storm Sewer Culverts (Existing)
49	STORMTEXT_EXI	Storm Sewer Text (Existing)
50	SIGN_EXI	Street Sign (Existing)
51	SIGN_PRO	Street Sign (Proposed)
52	SIGNTXT	Street Sign Text (Proposed)
53	STLIGHT_EXI	Street Lights (Existing)
54	STLIGHT_PRO	Street Light (Proposed)
55	STLIGHTTXT	Street Light Text (Proposed)

15.08 AutoCAD DRAWING GRAPHIC STANDARDS

- A. The following graphic standards shall apply to all construction plans submitted for approval to the City of Richmond that are within the city limits and extraterritorial jurisdiction.

GRAPHIC STANDARDS ~ EXISTING IMPROVEMENTS

1.1 Plan Feature	Plan View	WT	LC
ROW Line		3	0
Property Line		3	0
Lot Lines		1	0
Easement Line		0	2
Theoretical Property Line		3	0
Dimension Line		0	0
Ditches, Left (North Side)		0	0
Center Line of Ditches		0	2
Ditches, Left (South Side)		0	0
Edge Asphalt		0	0
Edge Concrete		0	0
Edge Shell or Gravel		0	2
Curb Line		0	0
Center Line of Right of Way		0	4
Transit Line/Baseline		0	0
Fence Line		0	0
Gas Line		0	1
Electrical Service Aerial Line		0	0
Electrical Service Conduit Line		0	6
Pipeline and/or Western Union Conduit		0	1
Telephone/Communications Conduit		0	2
Misc. Underground Lines		0	8
Cable TV		0	2
Railroad		0	0
Match Line (Line Weight 3)		3	0

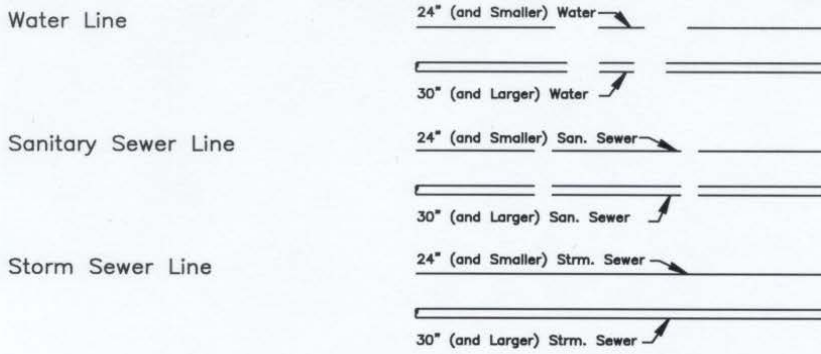
WT	TECHNICAL PEN NUMBER	LINE WEIGHT/WIDTH	METRIC
0	0	0.014"	.35mm
1	1	0.020"	.50mm
2	2	0.024"	.60mm
3	3	0.031"	.80mm
4	4	0.047"	1.20mm
6	6	0.055"	1.40mm

LEGEND

WT= LINE WEIGHT
LC= LINE CODE

GRAPHIC STANDARDS~EXISTING IMPROVEMENTS (Continued)

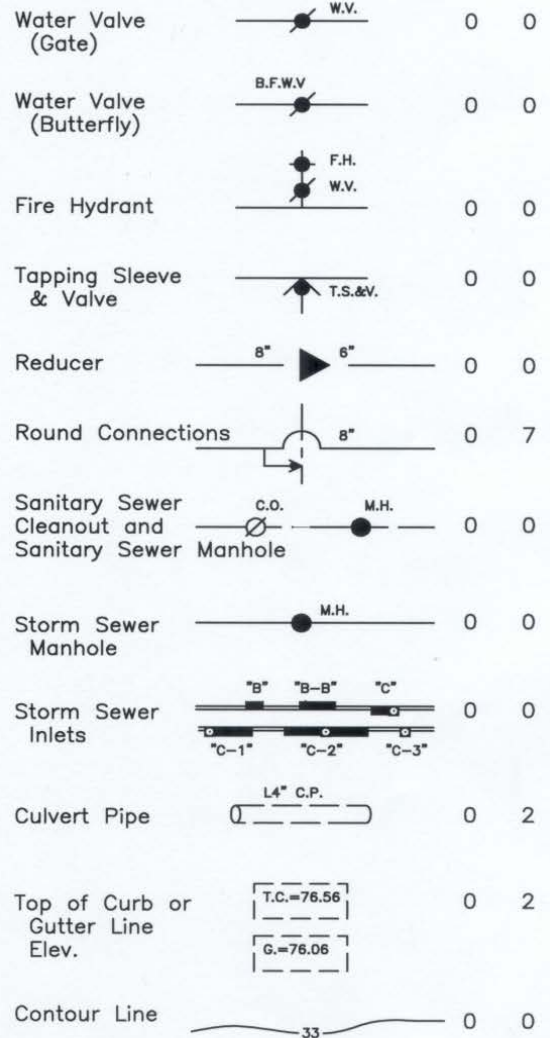
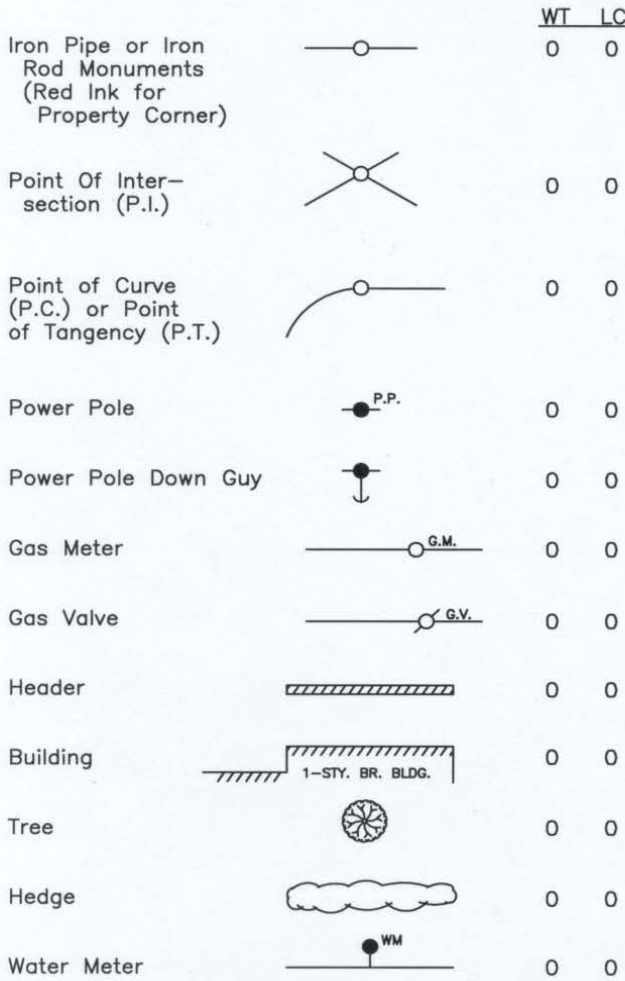
WT LC



0 7

0 3

0 0






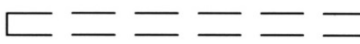
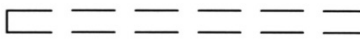
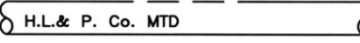
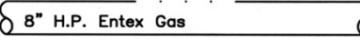
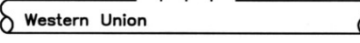


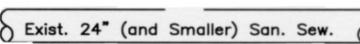
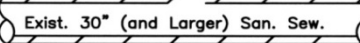
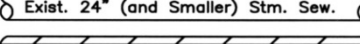
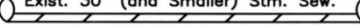


WT	TECHNICAL PEN NUMBER	LINE WEIGHT/WIDTH	METRIC
0	0	0.014"	.35mm
1	1	0.020"	.50mm
2	2	0.024"	.60mm
3	3	0.031"	.80mm
4	4	0.047"	1.20mm
6	6	0.055"	1.40mm

LEGEND

WT= LINE WEIGHT
LC= LINE CODE

GRAPHIC STANDARDS~EXISTING IMPROVEMENTS (Continued)

1.2 Profile View		WT	LC
North or East Property Line		1	5
South or West Property Line		1	6
North or East Ditch or Curb		1	7
South or West Ditch or Curb		1	3
Center Line of Right-of-Way		1	4
North or East Culvert		1	2
South or West Culvert		1	2
H.L.& P Co. Conduit		1	6
		1	0
Gas Line		1	1
		1	0
Western Union		1	1
		1	0
S.W.B Telephone Conduit		1	2
		1	0
Water Line		1	7
		1	0
Wastewater Line		1	3
		1	0
		1	3
		1	0
Storm Sewer Line		1	0
		1	0
		1	0
		1	0

NOTE: Pipe less than four inches (4") in diameter need not be shown in profile.

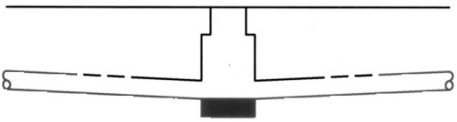
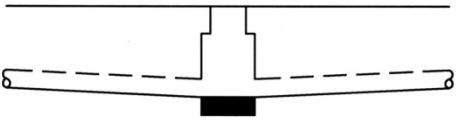

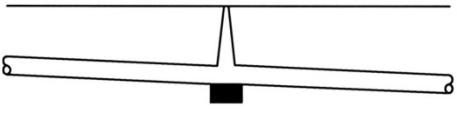
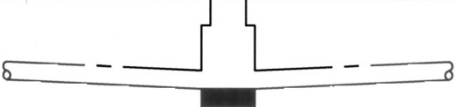
WT	TECHNICAL PEN NUMBER	LINE WEIGHT/WIDTH	METRIC
0	0	0.014"	.35mm
1	1	0.020"	.50mm
2	2	0.024"	.60mm
3	3	0.031"	.80mm
4	4	0.047"	1.20mm
6	6	0.055"	1.40mm

LEGEND

WT= LINE WEIGHT
LC= LINE CODE

GRAPHIC STANDARDS~EXISTING IMPROVEMENTS (Continued)

1.2 Profile View (Cont.)

		<u>WT</u> <u>LC</u>
Electrical Co. Manhole		1 6
Telephone/Comm. Manhole		1 2
Sanitary Sewer Manhole and Cleanout		1 3
Storm Sewer Manhole		1 0
Waterline Manhole		1 7

WT	TECHNICAL PEN NUMBER	LINE WEIGHT/WIDTH	METRIC
0	0	0.014"	.35mm
1	1	0.020"	.50mm
2	2	0.024"	.60mm
3	3	0.031"	.80mm
4	4	0.047"	1.20mm
6	6	0.055"	1.40mm

LEGEND









WT= LINE WEIGHT
LC= LINE CODE

GRAPHIC STANDARDS~PROPOSED IMPROVEMENTS

2. The following standards are to be used for all proposed water line improvements. Use line weight 3 for all proposed improvements. All fitting descriptions shall be shown in a box with arrow to the fitting or group of fittings. Text for proposed improvements shall not be smaller than 100 Leroy Template.

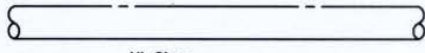
2.1. Plan View

WT LC

	24" (and Smaller) Water Main		3	7
Water Line			3	7
	30" (and Larger) Water Main			
Water Valve (Gate)			3	7
Water Valve (Butterfly)			3	7
Tapping Sleeve and Valve			3	7
Fire Hydrant			3	7
Reducers			3	7
Round Connections			3	7

2.2. Profile View

WT LC

Water Line		3	7
	All Sizes	3	0

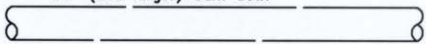
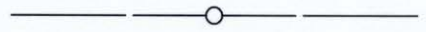

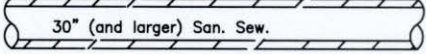
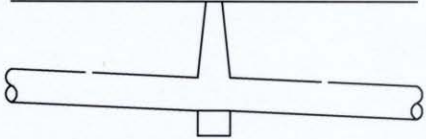
WT	TECHNICAL PEN NUMBER	LINE WEIGHT/WIDTH	METRIC
0	0	0.014"	.35mm
1	1	0.020"	.50mm
2	2	0.024"	.60mm
3	3	0.031"	.80mm
4	4	0.047"	1.20mm
6	6	0.055"	1.40mm

LEGEND

WT= LINE WEIGHT
LC= LINE CODE

GRAPHIC STANDARDS~PROPOSED IMPROVEMENTS (Continued)

3. The following standards are to be used for all proposed sanitary sewer line improvements. Use line weight 3 for all proposed improvements. All fitting descriptions shall be shown in a box with arrow to the fitting or group of fittings. Text for proposed improvements shall not be smaller than 100 Leroy Template.

3.1. Plan View		<u>WT</u> <u>LC</u>
	24" (and smaller) San. Sew.	3 3
Sanitary Sewer Lines	30" (and larger) San. Sew. 	3 3
Manhole		3 0
3.2. Profile View		<u>WT</u> <u>LC</u>
	24" (and smaller) San. Sew.	3 3
Sanitary Sewer Lines		3 0
	30" (and larger) San. Sew.	3 3
		3 0
Manhole		3 0

WT	TECHNICAL PEN NUMBER	LINE WEIGHT/WIDTH	METRIC
0	0	0.014"	.35mm
1	1	0.020"	.50mm
2	2	0.024"	.60mm
3	3	0.031"	.80mm
4	4	0.047"	1.20mm
6	6	0.055"	1.40mm

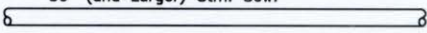

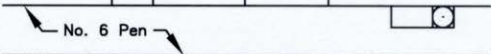
LEGEND

WT= LINE WEIGHT
LC= LINE CODE

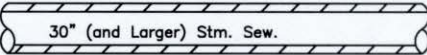
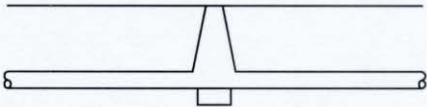
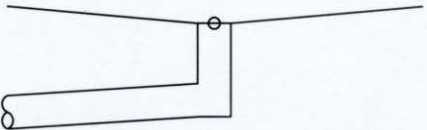
GRAPHIC STANDARDS~PROPOSED IMPROVEMENTS (Continued)

4. The following standards are to be used for all proposed storm sewer line improvements. Use line weight 3 for all proposed improvements. All fitting descriptions shall be shown in a box with arrow to the fitting or group of fittings. Text for proposed improvements shall not be smaller than 100 Leroy Template.

4.1. Plan View

		<u>WT</u>	<u>LC</u>
	24" (and smaller) Strm. Sew.		
	30" (and Larger) Strm. Sew.	3	0
Storm Sewer Lines		3	0
Manhole		3	0
	"B" "B-B" "c"	3	0
Inlets		3	0
	"c-1" "c-2" "c-3"	3	0

4.2. Profile View

	24" (and Smaller) Strm. Sew.	3	0
Storm Sewer Lines		3	0
Manhole		3	0
Inlet		3	0



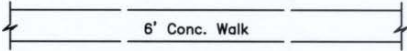


WT	TECHNICAL PEN NUMBER	LINE WEIGHT/WIDTH	METRIC
0	0	0.014"	.35mm
1	1	0.020"	.50mm
2	2	0.024"	.60mm
3	3	0.031"	.80mm
4	4	0.047"	1.20mm
6	6	0.055"	1.40mm

LEGEND

WT= LINE WEIGHT
LC= LINE CODE

GRAPHIC STANDARDS~PROPOSED IMPROVEMENTS (Continued)

5. The following standards are to be used for all proposed pavement improvements. Use line weight 3 for all proposed improvements. All fitting descriptions shall be shown in a box with arrow to the fitting or group of fittings. Text for proposed improvements shall not be smaller than 100 Leroy Template.

5.1. Plan View		<u>WT</u> <u>LC</u>
Face of Curb		6 3
Edge of pavement		6 0
Concrete Walk		3 3 2 0 3 3
Concrete Header		3 3
Top of Curb or Gutter Elevation		2 0

5.2. Profile View

Top of Curb or Center Line of Open Ditch Paving		2 0 (TEXT) 3 3
---	---	-------------------

WT	TECHNICAL PEN NUMBER	LINE WEIGHT/WIDTH	METRIC
0	0	0.014"	.35mm
1	1	0.020"	.50mm
2	2	0.024"	.60mm
3	3	0.031"	.80mm
4	4	0.047"	1.20mm
6	6	0.055"	1.40mm

LEGEND

WT= LINE WEIGHT
LC= LINE CODE

LINE CODE DEFINITIONS
ALL LENGTHS IN INCHES

LINE CODE "0" SOLID LINE

LINE CODE "1" .8" LINE, .05" SPACE, .025" LINE, .05" SPACE, .025" LINE, .05" SPACE, .025" LINE, .05" SPACE. .8" LINE

LINE CODE "2" .1875" LINE, .05" SPACE, .1875" LINE
- - - - -

LINE CODE "3" .9" LINE, .125" SPACE, .9" LINE

LINE CODE "4" 1.25" LINE, .125" SPACE, .030" LINE, .125" SPACE, 1.25" LINE
- - - - -

LINE CODE "5" .9" LINE, .125" SPACE, .03" LINE, .125" SPACE, .03" LINE, .125" SPACE, .03" LINE, .125" SPACE, .9" LINE
- - - - -

LINE CODE "6" .9" LINE, .125" SPACE, .1" LINE, .125" SPACE, .1" LINE, .125" SPACE .9" LINE

LINE CODE "7" .9" LINE, .1" SPACE, .1" LINE, .1" SPACE, .9" LINE
- - - - -

LINE CODE "8" .9" LINE, .2" SPACE, .9" LINE
|-----|-----|-----|-----|-----|-----|

END OF CHAPTER



City of Richmond

Design Manual

Chapter 16

MISCELLANEOUS REQUIREMENTS

CHAPTER 16

MISCELLANEOUS REQUIREMENTS

16.01 CROSSINGS

A. Highway and Street Crossings

1. State Highway crossings shall be constructed in conformance with the requirements of the Texas Department of Transportation and a TxDOT permit to perform work in its ROW is required. County road crossings shall be constructed in accordance with the requirements of Fort Bend. These permits shall be submitted with the Major Construction Improvement permit application to the Department of Public Works.
2. Where additional right-of-way has been acquired or will be required for future widening, the casing, where required, should be carried to within ten feet (10') of each future right-of-way line.
3. Conduits and sewers that do not carry liquid under pressure may be bored and jacked into place without an encasement pipe.
4. Crossings under existing concrete streets, other than major thoroughfares, shall be constructed by boring and jacking. P.V.C. pipe shall be jacked into place using equipment designed for that purpose. Water may be used to facilitate the boring and jacking operations. Jetting the pipe main into the place will not be permitted. When conditions exist that warrant open cut across an existing street, the Department of Public Works shall specifically approve the crossing. The City Engineer will be the deciding authority on whether an open cut is warranted and the limits of pavement removal and replacement that is necessary.
5. All open cut installations under existing or proposed streets shall be backfilled with cement stabilized sand in accordance with the City of Richmond Construction Details unless specifically exempted by the City Engineer.
6. All street crossings shall be constructed in accordance with construction plans approved by the City. All street crossings shall be inspected by the Department of Public Works. All street crossings shall meet the requirements of these Standards.

B. Railroad and Pipeline Crossings

1. For railroad crossings, the carrier pipe shall be encased in steel pipe casing extending from right-of-way to right-of-way.
2. All construction within the railroad or pipeline right-of-way shall conform to minimum requirements set out in the agreement with the owner of the right-of-way.
3. Copies of the permits and /or agreements from the railroad or pipeline shall be provided with the Major Construction Improvement permit application to the Department of Public Works.

C. Ditch and Stream Crossings

1. Crossing under a stream or ditch rather than an aerial crossing is required unless specifically approved by the City Engineer. The top of the carrier pipe shall be designed to provide a minimum clearance of at least four feet (4') below the ultimate flow line and sides of the ditch and with sufficient bottom length to exceed the ultimate future ditch sections.
2. Where existing or proposed bridges have sufficient space and structural capacity for installing water mains or conduits (twelve inches (12") or smaller) under the bridge, but above the top of the bent cap elevation, such installation will be permitted upon specific approval of the construction plans. In all cases, the water main or conduit shall be above the bottom chord of the bridge and eighteen inches (18") above the 100-year water surface elevation. All conduits attached to a bridge shall be constructed using Ductile Iron Pipe and shall extend a minimum of ten feet (10') beyond the bridge bent or to the right-of-way line, whichever is greater. All conduit attached to a bridge shall be maintained by the owner of the conduit or will be subject to removal.
3. Separate, freestanding crossings across drainage ways are not allowed.
4. All stream or ditch crossings shall be constructed of steel pipe from right-of-way line to right-of-way line.

16.02 TRENCH SAFETY

- A. All construction within the City of Richmond and its extraterritorial jurisdiction shall conform to federal and state requirements. Trench safety is required for all excavations greater than five feet (5') in depth. The contractor shall prepare or obtain the appropriate safety systems, including current OSHA standards for trench safety. Design of trench safety systems, sealed by a licensed professional engineer, shall be submitted by the contractor prior to the execution of work.

16.03 RESIDENTIAL LOTS AND IMPROVEMENTS

- A. All residential lots shall drain to a public right-of-way directly adjoining the lot. Drainage from a residential lot to a public right-of-way at the rear or side of a lot may be permitted provided the drainage system has been properly designed to accept the flow. Drainage from a residential lot to an adjoining greenbelt or golf course shall require a public easement for drainage purposes to be maintained by the homeowner's association or appropriate private entity. Drainage to a private easement shall require specific approval by the Public Works Department. Drainage to a private easement shall be noted on the recorded subdivision plat. The Fort Bend County Drainage District shall approve drainage to a Fort Bend County drainage easement.
- B. Positive overflow drainage pathways or other drainage routes that are along or parallel side lot lines shall be enclosed within a separate reserve unless the 100-year storm event is contained within a below grade conduit. If the 100-year event is contained below grade, the conduit may be enclosed within a drainage easement rather than a separate reserve.
- C. A lot-grading plan showing proposed minimum slab elevations should be included in the

construction plans. If slab elevations do not change, a notice of minimum elevation will suffice. The minimum slab elevation shall also be shown on the subdivision plat. Minimum slab elevations for all structures shall be constructed as noted below:

1. For structures outside the Special Flood Hazard Area - 18 inches above the top of curb in the front of the parcel or 18 inches above the highest adjacent grade, or 12 inches above the calculated 100-yr hydraulic grade line (HGL) at the nearest storm drainage system, whichever is higher.
2. For all structures within the Special Flood Hazard Area – Either the requirement specified in subsection 17.03.C.1. above, or 12 inches above the Base Flood Elevation as shown on the effective Flood Insurance Rate Map for the property, whichever is greater.

16.04 FLOOD PLAIN MANAGEMENT

- A. All development shall conform to the requirements of the National Flood Insurance Program, as required by the regulations of the local governing authority having jurisdiction.
- B. Amendments to the published flood maps, map revisions and all requests for changes to the base flood elevation within the Richmond city limits shall be submitted to the City of Richmond for approval. Technical data required by the Federal Emergency Management Agency and justification for the proposed change must be included with all requests. All requests for changes to the base flood elevation within the City of Richmond extraterritorial jurisdiction shall be submitted to the City of Richmond for comments for approval. All data submitted shall be prepared under the supervision of a Professional Engineer and shall comply with all requirements of the Federal Emergency Management Agency.

16.05 BARRICADES AND TRAFFIC CONTROL

- A. It is the responsibility of the developer, contractor, or right-of-way user to maintain traffic control devices in accordance with Texas Manual on Uniform Traffic Control Devices (TMUTCD) on all construction projects.
- B. Construction projects which have not been accepted by the City shall be barricaded or otherwise closed to public use until acceptance by the City. It is the responsibility of the contractor to provide and maintain barricades or other traffic control devices in accordance with the TMUTCD, latest edition, and in a safe manner.

16.06 APPROVED PRODUCTS LIST

- A. The Department of Public Works shall develop and maintain an Approved Products List. All materials used in construction within right-of-ways and easements shall be as specified on the City of Richmond Approved Products list.

16.07 RICHMOND CITY STANDARD CONSTRUCTION DETAILS

- A. The Department of Public Works shall develop and maintain Standard Construction Details.

These Standard Construction Details shall be maintained and updated periodically by the Department of Public Works.

END OF CHAPTER

CITY OF RICHMOND - DEPARTMENT OF PUBLIC WORKS
APPROVED PRODUCTS LIST
REVISED JANUARY 2019

- 1. Fire Hydrants (Flushing Valves, AWWA C 502)**
(Main Valve 5-1/4 inch, Steamer/Pumper Nozzle 4 1/2 inch NST, Hose Nozzles (2) 2 1/2 inch NST)
 - A. Mueller - Model: Super Centurion 250, Option 110
 - B. Kennedy - Model: Guardian K 81-A
 - C. American Darling - Model: B 84-B
 - D. East Jordan Iron Works – Water Master – Model 5CD 250

- 2. Gate Valves (3/4 inch thru 2 inch, AWWA Approved, Bronze)**
 - A. Hammond
 - B. Watts
 - C. Matco Norca
 - D. Eagle
 - E. C and K
 - F. Mueller
 - G. Municipal Valve & Equipment Company

- 3. Gate Valves (3 inch and larger, AWWA C 509, Resilient Wedge Type)**
 - A. Mueller
 - B. Waterous
 - C. American Flow
 - D. Kennedy
 - E. M & H
 - F. US Valve
 - G. East Jordan Ironworks
 - H. AVK

- 4. PVC Pipe (AWWA C900Pipe)**
 - A. All manufacturers compliant with AWWA and/or ASTM Standards.

- 5. Ductile Iron Fittings for C 900, Pipe (AWWA C 110, AWWA C 153)**
 - A. All manufacturers compliant with AWWA and/or ASTM standards.

- 6. Steel Pipe (AWWA C 200)**
 - A. All manufacturers compliant with AWWA and/or ASTM standards.

- 7. Restraint Joint Pipe (AWWA C 110, C 153, or C151)**
 - A. Certain Teed – Certa-Lok C 905/C 909 Pipe

- 8. Steel Pipe Coatings, Exterior (AWWA C 203)**
 - A. All manufacturers compliant with AWWA and/or ASTM standards.

- 9. Steel Pipe Coatings, Interior (AWWA C 210, D 102, TCEQ NSF 61)**
 - A. All manufacturers compliant with AWWA and/or ASTM standards.
Bituminous interior coatings are not allowed.

- 10. Curb Stops**
- I. Curb Stop (1" & 2") - Bronze, Ball Valve, 360° Rotation, Locking Wing – Full Port, Pack Joint CTS O.D. Tubing X FIP**
- A. Ford
 - B. Mueller - Model: Mark II Oriseal
 - C. James Jones
 - D. MacDonald
 - E. Cambridge
- II. Curb Stop (3/4" Ball Valve Full Port, Locking Wing – FIP X FIP)**
- A. Ford Meter Box Company
 - B. Cambridge
 - C. Mueller
 - D. James Jones
 - E. Macdonald
- 11. Corporation Stop - Bronze**
- A. Ford - Model: F100
 - B. Mueller - Model: H-15008 or H-15013
 - C. James Jones
 - D. MacDonald
 - E. Cambridge
- 12. Compression Coupling (1"-2") Pack Joint, CTS O.D. Tubing Connections**
- A. Cambridge
 - B. Ford Meter Box Company
 - C. Mueller
- 13. Service Saddle - Dual Strap, Stainless Steel, Epoxy Coated Saddle**
- A. Ford
 - B. Mueller
 - C. James Jones
 - D. MacDonald
 - E. JCM
 - F. Romac
- 14. Service Saddle - Single Wide-Band Strap, Stainless Steel, Epoxy Coated Saddle**
- A. Romac, Series 101N
- 15. Water Meters (AWWA Approved)**
- A. Badger
 - B. Sensus (old Rockwell)
 - C. Master Meters
- 16. Service Tubing (3/4 inch thru 2 inch Tubing)**
- A. EndoPure Virgin Polyethylene – by ENDOT
- 17. Air Release Valve, 2 inch (Bonney Forge 3,000# threadolet)**
- A. APCO - No. 200
 - B. Val-matic, 2 inch
- 18. Pipe Casing Spacers and End Seals for Bored Crossings**
- A. Pipeline Seal and Insulator (PSI)
 - B. Ranger

- 19. Meter Boxes**
- A. Concrete Box and Flush Mount Lid, Cast Iron Hinged Reader
 - 1. Brooks Products
 - 2. Old Castle
- 20. Pipe and Fitting Restraints (New Section 2/2011)**
- A. EBAA Iron Inc. – Megalug Series (New Item 5/2011)
 - B. Star Pipe – Pipe Restraints Stargrip Series 1100 for PVC (New Item 2/2011)
 - C. Star Pipe – Pipe Stargrip Series 4000 MJ Wedge Restraint (New Item 2/2011)
 - D. Smith Blair – Camlock 111 – 4”-24” (New Item 5/2011)
 - E. Sigma – One-Lock Series SLCE for PVC Pipe (New Item 5/2011)
 - F. Sigma – One-Lock Series SLDE for Ductile Iron Pipe (New Item 10/2011)
 - G. SIP Industries – EZ Grip Joint Restraint for PVC Pipe (New Item 3/2012)
 - H. Star Pipe – Ductile Iron Mechanical Wedge Restraint Joint (New Item 10/2013)
 - I. RTC – Flange Adaptor RCT DI C 900
 - J. RTC – Flex-Tite Bends (90, 45, 22.5, 11.25)
 - K. RTC – Flex-Tite Tees/Reducing Tees
 - L. RTC – Flex-Tite Reducers/Wyes
 - M. RTC – Flex-Tite Caps
 - N. RTC – Flex-Tite Tees
 - O. Tyler
- 21. Tapping Valves**
- A. Mueller
 - B. American Flow
 - C. Kennedy
 - D. Hammond
 - E. US Valve
 - F. Municipal Valve and Equipment Company
 - G. East Jordan Iron Works 2”-16”
- 22. Tapping Sleeves (All to be Stainless Steel)**
- A. JCM – Stainless Sleeve 432 and 462
 - B. Ford Meter Box Co. (3-2012)
 - C. TPS (4”-16”)
 - D. Smith & Blair
 - E. Romac
- 23. Check Valves**
- A. AVK and Red Valve Tide Flex Series 39

CITY OF RICHMOND - DEPARTMENT OF PUBLIC WORKS
APPROVED SANITARY SEWER PRODUCTS LIST
REVISED JANUARY 2019

- 1. Gravity Flow Pipes (AWWA C 900, C905, ASTM D 3034 by J-M Manufacturing, CertainTeed Corp., Diamond Plastics Corp., or Carlon Company) (ASTM C 76 – Various Manufacturers)**
 - A. PVC, 12 inches and smaller to max. depth of 12 feet – SDR 26, min. 160 PSI rating, ASTM D 3034 pipe, D3212 joint with F477 rubber gasket
 - B. PVC, 12 inches and smaller exceeding 12 feet in depth – AWWA C 900, DR 18, Class 150 pipe, joined per ASTM 3139 with F477 rubber gasket
 - C. PVC, Larger than 12 inches and smaller than 24 inches to max. depth of 12 feet – DR 25, min. 165 PSI rating, ASTM D 3034 pipe, D3212 joint with F477 rubber gasket
 - D. PVC, Larger than 12 inches and smaller than 24 inches exceeding 12 feet in depth - AWWA C 905, DR 18, Class 235 pipe, joined per ASTM 3139 with F477 rubber gasket
 - E. PVC, 24 inches and larger at all depths – AWWA C 900, DR 18, Class 235 pipe, joined per ASTM 3139 with F477 rubber gasket

- 2. Force Mains (AWWA C 900, Pipe)**
 - A. All manufactures compliant with AWWA and/or ASTM Standards.

- 3. Ductile Iron Fittings for C 900, C 905 Pipe (AWWA C 110, AWWA C 153)**
 - A. All manufacturers compliant with AWWA and/or ASTM standards.

- 4. PVC Drainage Pattern Fittings for SDR 26 and DR 25 Pipe (ASTM D 3034)**
 - A. GPK
 - B. J-M Manufacturing
 - C. Vassallo
 - D. Plastic Trends
 - E. Royal

- 5. Pipe Connectors / Adapters / Flexible Couplings**
 - A. Indiana Seal
 - B. Flow Control
 - C. Flow Seal
 - D. DFW
 - E. Fernco

- 6. Coating for Manholes (40 Mils. Minimum Thickness) - Coating Must have 10 year warranty on installation and maintenance**
 - A. Versa Flex FE 100
 - B. Aquatapoxy A-6
 - C. Themec Series 66 epoxy coating
 - D. Aegis Coating Technologies epoxy coating
 - E. Quadex Aluminaliner calcium aluminate sewer rehabilitation mortar (minimum 1 inch / maximum 3 inch thickness)
 - F. SpectraShield
 - G. Kerneos Sewpercoat

7. **Manhole Rehabilitation – H2S Corrosion & Inflow/Infiltration - Coating Must have 10 year warranty on installation and maintenance**
 - A. Kernos Sewpercoat (New Item 1/2011)
 - B. Standard Cement – Reliner MSP or Maximum CA Cement with Standard Shield Epoxy (Acropoxy 4582)
 - C. Quadex Aluminaliner calcium aluminate sewer rehabilitation mortar (minimum 1 inch/maximum 3 inches thickness) with Quadex Structure Guard Epoxy or Raven 405

8. **Manhole Covers and Rings, Richmond Specs, (ASTM A 48, AASHTO H-20 Load Rating)**
 - A. Vulcan Foundry – 32 inch diameter, Model V-2420
 - B. Neenah Foundry – 32 inch diameter, Model R-1741-F
 - C. East Jordan Iron Works, Inc. – 32 inch diameter, Model V-1420
 - D. Star Pipe Products – 32 inch diameter, COMC Spec.

9. **Manhole Inserts (No Flow/In-Flow Protector)**
 - A. Contractor Specialties and Supply Co.

10. **Manholes (Precast Concrete, Richmond Specifications)**
 - A. Old Castle Precast
 - B. Hanson Pipe and Precast
 - C. Forterra Precast
 - D. South Houston Precast
 - E. Koastal Precast, Inc.
 - F. NC Pipe
 - G. Aqua Vault
 - H. Park USA

11. **Lift Station Submersible Pumps**
 - A. Flyght
 - B. ABS
 - C. Gorman Rupp
 - D. KSB

12. **Lift Station Dry Pit Pumps – By exception only**

13. **Lift Station Wet Well Rehabilitation - Coating Must have 10 year warranty on installation and maintenance**
 - A. Kernos Sewpercoat (New Item 1/2011)
 - B. Standard Cement – Reliner MSP or Maximum CA Cement with Standard Shield Epoxy (Acropoxy 4582)
 - C. Quadex Aluminaliner calcium aluminate sewer rehabilitation mortar (minimum 1 inch /maximum 3 inches thickness) with Quadex Structure Guard Epoxy (New Item 9/201
 - D. Raven 405 Epoxy

14. **New Lift Station Wet Well Installation - Coating Must have 10 year warranty on installation and maintenance**
 - A. Standard Cement Materials, Inc. (Acropoxy 4582 epoxy coating)
 - B. Poly-Triplex Technologies, Inc. (Poly-Triplex Liner System)
 - C. Kernos Sewpercoat (New Item 1/2011)
 - D. Raven 405 Epoxy (New Item 11/2011)
 - E. Quadex Structure Guard Epoxy (New Item 9/2013)

- 15. Lift Station Control Panels – Control Panel must contain the City’s standard equipment for Duplex and Triplex lift stations in Appendix A**
 - A. E.G. Controls
 - B. Consolidated Electric
 - C. Murphymatic
 - D. Sta-Con, Inc.
 - E. Automatic Control Systems
 - F. Mercer Controls Division
 - G. Motor Controls, Inc.
 - F. Macaulay Controls Company

- 16. Check Valve**
 - A. Stockman
 - B. Watts
 - C. Sepco
 - D. Mission
 - E. Val-matic
 - F. CCNE
 - G. Tideflex

- 17. Non-Shrink Grout**
 - A. Fosrok Preco Patch

- 18. Geotextile Fabric Wrap**
 - A. Trevira S1114

CITY OF RICHMOND - DEPARTMENT OF PUBLIC WORKS
APPROVED STORM SEWER PRODUCTS LIST
REVISED JANUARY 2019

- 1. Manhole Covers and Rings, Richmond Specs, (ASTM A 48, AASHTO H-20 Load Rating)**
 - A. Vulcan Foundry – 32 inch diameter, Model V-2420
 - B. Neenah Foundry – 32 inch diameter, Model R-1741-F
 - C. East Jordan Iron Works, Inc. - 32 inch diameter, Model V-1420
 - D. Star Pipe Products – 32 inch diameter, COMC Spec.

- 2. Storm Inlet Grates and Frames, Richmond Specs (ASTM A 48, AASHTO H-20 Load Rating)**
 - A. Vulcan Foundry
 - B. Neenah Foundry
 - C. East Jordan Iron Works, Inc.

- 3. Reinforced Concrete Pipes and Driveway Culverts (ASTM C 76, ASTM C 443 – Various Manufacturers)**
 - A. RCP, 24 inch and larger at all depths – ASTM C 76 with rubber gasketed joints conforming to ASTM 433

- 4. Reinforced Concrete Box Culverts (ASTM C 789, C 850, AASHTO M259, M 273 – Various Manufacturers)**
 - A. RCB, 24 inches X 24 inches and larger having min. 2 feet to max. 12 feet of cover – ASTM C 789/AASHTO M 259 joined with “Ramnek” joint sealing compound by K.T. Snyder Co.
 - B. RCB, 24 inches X 24 inches and larger having less than 2 feet cover or greater than 12 feet of cover – ASTM C 850/AASHTO M 276 joined with “Ramnek” joint sealing compound by K.T. Snyder Co.

- 5. Asphalt Coated Corrugated Metal Outfall Pipes To Receiving Channels In Drainage Easements (AASHTO M 36, M 190, M 218 – Various Manufacturers)**
 - A. CGMP, 24 inches and larger to max. depths recommended by manufacturer - AASHTO M 218, M 36, galvanized corrugated steel pipe joined with coupling bands as per manufacturer's recommendations
 - B. CGMP, 24 inches and larger to max. depths recommended by manufacturer - AASHTO M 218, M 36, M 190, galvanized corrugated steel pipe with bituminous coating joined with coupling bands as per manufacturer's recommendation

- 6. Manholes and Storm Inlets (Precast Concrete, Richmond Specifications)**
 - A. Old Castle Precast
 - B. Hanson Pipe and Precast
 - C. Forterra Precast
 - D. South Houston Precast
 - E. Koastal Precast, Inc.
 - F. NC Pipe
 - G. Aqua Vault
 - H. Park USA
 - I. Hanson Pipe and Precast
 - J. Southern Precast
 - K. Koastal Precast, Inc.
 - L. Aqua Vault, Ltd
 - M. Park USA
 - N. NC Pipe

- 7. Geotextile Fabric Wrap**
 - A. Trevira S1114

CITY OF RICHMOND - DEPARTMENT OF PUBLIC WORKS
APPROVED STREET PRODUCTS LIST
REVISED JANUARY 2019

- 1. Raised Pavement Markers (Class A, B, C & D)**
 - A. Apex Universal

- 2. Type Y and Type W Traffic Buttons (ceramic only)**
 - A. Apex Universal

- 3. Raised Pavement Marker Adhesive**
 - A. Bundy Raised Pavement Marker Adhesive
 - B. TxDOT approved epoxy

- 4. Thermoplastic Pavement Markings (125 mils thick)**
 - A. Flint Trading Inc. - Premark LKF Roadmarking Material

- 5. Prefabricated Pavement Markings (125 mils thick)**
 - A. Flint Trading Inc. - Premark LKF Roadmarking Material

- 6. Thermoplastic Adhesive**
 - A. Ashland Chemicals - Pliobond 10

- 7. Crack and Joint Sealant (Various Manufacturers)**
 - B. Crafco Manufacture Polyflex 3
 - C. Sikadur 50

- 8. Paints (Various Manufacturers)**
 - A. Only Water Based conforming to TxDOT Specifications are approved for use in the City of Richmond

- 9. Road Marker Posts**
 - A. Carsonite # CRM-375

- 10. Replaceable Delineator Post w/ Base (Epoxy or 8" Bundy Adhesive)**
 - A. Repo TM Model

- 11. Concrete Curing Membranes (Various Manufacturers)**
 - A. Liquid membrane-forming Curing Compound conforming to TxDOT Item 526 and TxDOT Departmental Material Specification D-9-8120

- 12. Chemical Stain for Use on Ramps for Handicapped Access, Cola Color (A.D.A., Texas Accessibility Standards.)**
 - A. Kemiko Concrete Products – “Cola” color

- 13. Traffic Control Signalization, Lighting and Appurtenances (Various Manufacturers)**
 - A. All materials and manufactured products pertaining to traffic control signals, lighting, and associated appurtenances shall conform to current Texas Department of Transportation specifications and shall be listed in the TxDOT Prequalified Master List of Approved Products at time of installation.

General

Root Barriers:

Deeproot Model UB 24-2

BioBarrier Root Control Fabric

Century Root Barrier Rigid Root Panel

DeepRoot linear models

NOTE: Materials and manufactured items utilized for construction of public infrastructure in public rights-of-way and easements within the corporate limits and extraterritorial jurisdiction of Richmond, Texas shall comply in all respects with those listed above in this Approved Products List.

Materials and manufactured items not listed herein may be submitted to the Department of Public Works for review and consideration on a case by case basis. In no instance shall such items be installed without specific approval having been granted by the Department of Public Works prior to construction.

Appendix A

CITY OF RICHMOND
DUPLEX LIFT STATION – BILL OF MATERIALS

1 ENCLOSURE 36x30x12 NEMA 4X STAINLESS STEEL, HOFFMAN A-36H3012SSLP
WITH ALUMINUM BACKPLANE 36x30
1 INNER DOOR, ALUMINUM SHOP MADE AND PAINTED MEDIUM BLUE
1 POWER DISTRIBUTION BLOCK, GOULD-SHAWMUT 63133
1 NEUTRAL BLOCK, GOULD-SHAWMUT 63131
1 FUSE BLOCK 3-POLE, GOULD-SHAWMUT 30323 W/FUSES
3 SAFETY FUSE PULLERS, GOULD-SHAWMUT DFC3M
1 8-SPACE LIGHTING PANEL, SQUARE D QO816L100F W/MAIN BREAKER QO215
1 GROUND BAR KIT, SQUARE D PK9-GTA
8 SINGLE-POLE CIRCUIT BREAKERS, SQUARE D QO120
1 PHASE MONITOR RELAY, DIVERSIFIED PBD-230-ALE
1 DWYER MERCOID, EDAW-N1E1-02T1 SERIES EDA ELECTRONIC PRESSURE CONTROLLER
2 MOTOR CIRCUIT PROTECTORS, SQUARE D FAL36030-15M
2 STARTERS NEMA SIZE 1, SQUARE D 8536 SCO3V02S W/SO4 OVERLOAD MODULES
2 STARTER RESET PUSHBUTTONS, SQUARE D 9066 RA1
8 3PDT BLADE-BASE RELAYS, IDEC RR3-BUL-120VAC W/sockets
1 TIME DELAY RELAY, IDEC RTE-B11-120VAC W/Socket
1 TIME DELAY RELAY, IDEC RTE-B12-120VAC W/Socket
2 SEAL FAILURE RELAYS, WARRICK 16DMB1A0
1 AIR PUMP, INGRAM HR10WB3
1 AIR SWITCH, MICROMATIC MPL-502
1 PVC AIR CELL (SHOP-MADE)
AR MISCELLANEOUS FITTINGS & PIPING FOR PRESSURE SWITCHES
1 HEATER 50W 120V, WATLOW 010100C1
1 THERMOSTAT, FENWAL SERIES 30000-0
2 ELAPSED TIME METERS, CRAMER 635G
2 HAND/OFF/AUTO SWITCHES, SQUARE D 9001 KS43B W/KN260 LEGEND PLATES
1 2-POSITION SWITCH, SQUARE D 9001 KS11B
4 PUSHBUTTONS, SQUARE D 9001 KR1U
AR CONTACT BLOCKS FOR SWITCHES & PUSHBUTTONS, SQUARE D KA1, KA2, & KA3
2 TOGGLE SWITCHES, CARLINGSWITCH 2FA54-73
11 30MM FULL VOLTAGE PUSH-TO-TEST PILOT LIGHTS, IDEC ALD29911N (COLOR) 120V
1 GFCI, LEVITON 6599-I
1 ROTATING ALARM BEACON, EDWARDS 52R-N5-40W
1 ALARM BELL, FEDERAL SIGNAL VIBRATONE 504-120

CITY OF RICHMOND TRIPLEX PUMP CONTROLS – BILL OF MATERIALS

1	ENCLOSURE 48x36x12 NEMA 4X STAINLESS STEEL, HOFFMAN A48H3612SSLP WITH ALUMINUM BACKPLANE 48x36
1	INNER DOOR, ALUMINUM SHOP MADE AND PAINTED MEDIUM BLUE
1	POWER DISTRIBUTION BLOCK, GOULD-SHAWMUT 63133
1	NEUTRAL BLOCK, GOULD-SHAWMUT 63131
1	FUSE BLOCK 3-POLE, GOULD-SHAWMUT 30323 W/FUSES
3	SAFETY FUSE PULLERS, GOULD-SHAWMUT DFC3M
1	8-SPACE LIGHTING PANEL, SQUARE D QO816L100F WITH MAIN BREAKER QO215
1	GROUND BAR KIT, SQUARE D PK7-GTA
8	SINGLE-POLE CIRCUIT BREAKERS, SQUARE D QO120
1	PHASE MONITOR RELAY, DIVERSIFIED PBD-230-ALE
1	3-PUMP ALTERNATOR, DIVERSIFIED ARA-120-AHE
3	MOTOR CIRCUIT PROTECTORS, SQUARE D FAL36030-15M
3	STARTERS NEMA SIZE 1, SQUARE D 8536 SCO3V02S W/SO4 OVERLOAD MODULES
3	STARTER RESET PUSHBUTTONS, SQUARE D 9066 RA1
13	3PDT BLADE-BASE RELAYS, IDEC RR3-BUL-120VAC W/SOCKETS
3	TIME DELAY RELAYS, IDEC RTE-B11-120VAC W/SOCKETS
1	TIME DELAY RELAY, IDEC RTE-B12-120VAC W/SOCKET
3	SEAL FAIL RELAYS, WARRICK 16DMB1A0
2	PRESSURE SWITCHES, MERCOID DA531-3 RANGE 1
1	AIR PUMP, INGRAM HR10WB3
1	AIR SWITCH, MICROMATIC MPL-502
1	PVC AIR CELL (SHOP-MADE)
AR	MISCELLANEOUS FITTINGS & PIPING FOR PRESSURE SWITCHES
1	HEATER 50W 120V, WATLOW 010100C1
1	THERMOSTAT, FENWAL SERIES 30000-0
3	ELAPSED TIME METERS, CRAMER 635G
3	HAND/OFF/AUTO SWITCHES, SQUARE D 9001 KS43B W/KN260 LEGEND PLATES
1	2-POSITION SWITCH, SQUARE D 9001 KS11B
5	PUSHBUTTONS, SQUARE D 9001 KR1U
AR	CONTACT BLOCKS FOR SWITCHES & PUSHBUTTONS, SQUARE D KA1, KA2, & KA3
2	TOGGLE SWITCHES, CARLINGSWITCH 2FA54-73
14	30MM FULL VOLTAGE PUSH-TO-TEST PILOT LIGHTS, IDEC ALD29911N(COLOR)120V
1	GFCI, LEVITON 6599-I
1	ROTATING ALARM BEACON, EDWARDS 52R-N5-40W
1	ALARM BELL, FEDERAL SIGNAL VIBRATONE 504-120